

SUNSTAR商斯达实业集团是集研发、生产、工程、销售、代理经销、技术咨询、信息服务等为一体的高科技企业，是专业高科技电子产品生产厂家，是具有 10 多年历史的专业电子元器件供应商，是中国最早和最大的仓储式连锁规模经营大型综合电子零部件代理分销商之一，是一家专业代理和分销世界各大品牌 IC 芯片和电子元器件的连锁经营综合性国际公司。在香港、北京、深圳、上海、西安、成都等全国主要电子市场设有直属分公司和产品展示展销窗口门市部专卖店及代理分销商，已在全国范围内建成强大统一的供货和代理分销网络。我们专业代理经销、开发生产电子元器件、集成电路、传感器、微波光电元器件、工控机/DOC/DOM 电子盘、专用电路、单片机开发、MCU/DSP/ARM/FPGA 软件硬件、二极管、三极管、模块等，是您可靠的一站式现货配套供应商、方案提供商、部件功能模块开发配套商。专业以现代信息产业（计算机、通讯及传感器）三大支柱之一的传感器为主营业务，专业经营各类传感器的代理、销售生产、网络信息、科技图书资料及配套产品设计、工程开发。我们的专业网站——**中国传感器科技信息网（全球传感器数据库）www.SENSOR-IC.COM** 服务于全球高科技生产商及贸易商，为企业科技产品开发提供技术交流平台。欢迎各厂商互通有无、交换信息、交换链接、发布寻求代理信息。欢迎国外高科技传感器、变送器、执行器、自动控制产品厂商介绍产品到 中国，共同开拓市场。本网站是关于各种传感器-变送器-仪器仪表及工业自动化大型专业网站，深入到工业控制、系统工程计 测量、自动化、安防报警、消费电子等众多领域，把最新的传感器-变送器-仪器仪表买卖信息，最新技术供求，最新采购商，行业动态，发展方向，最新的技术应用和市场资讯及时的传递给广大科技开发、科学研究、产品设计人员。本网站已成功为石油、化工、电力、医药、生物、航空、航天、国防、能源、冶金、电子、工业、农业、交通、汽车、矿山、煤炭、纺织、信息、通信、IT、安防、环保、印刷、科研、气象、仪器仪表等领域从事科学研究、产品设计、开发、生产制造的科技人员、管理人员、和采购人员提供满意服务。**我公司专业开发生产、代理、经销、销售各种传感器、变送器、敏感元器件、开关、执行器、仪器仪表、自动化控制系统：专门从事设计、生产、销售各种传感器、变送器、各种测控仪表、热工仪表、现场控制器、计算机控制系统、数据采集系统、各类环境监控系统、专用控制系统应用软件以及嵌入式系统开发及应用等工作。如热敏电阻、压敏电阻、温度传感器、温度变送器、湿度传感器、湿度变送器、气体传感器、气体变送器、压力传感器、压力变送、称重传感器、物（液）位传感器、物（液）位变送器、流量传感器、流量变送器、电流（压）传感器、溶氧传感器、霍尔传感器、图像传感器、超声波传感器、位移传感器、速度传感器、加速度传感器、扭距传感器、红外传感器、紫外传感器、火焰传感器、激光传感器、振动传感器、轴角传感器、光电传感器、接近传感器、干簧管传感器、继电器传感器、微型电泵、磁敏（阻）传感器、压力开关、接近开关、光电开关、色标传感器、光纤传感器、齿轮测速传感器、时间继电器、计数器、计米器、温控仪、固态继电器、调压模块、电磁铁、电压表、电流表等特殊传感器。同时承接传感器应用电路、产品设计和自动化工程项目。**

欢迎索取免费详细资料、设计指南和光盘；产品凡多，未能尽录，欢迎来电查询。

更多产品请看本公司产品专用销售网站：

商斯达中国传感器科技信息网：<http://www.sensor-ic.com/>

商斯达工控安防网：<http://www.pc-ps.net/>

商斯达电子元器件网：<http://www.sunstare.com/>

商斯达微波光电产品网：[HTTP://www.rfoe.net/](http://www.rfoe.net/)

商斯达消费电子产品网：<http://www.icasic.com/>

商斯达军工产品网：<http://www.junpinic.com/>

商斯达实业科技产品网：<http://www.sunstars.cn/>传感器销售热线：

地址：深圳市福田区福华路福庆街鸿图大厦 1602 室

电话：0755-83607652 83376489 83376549 83370250 83370251 82500323

传真：0755-83376182 (0) 13902971329 MSN: SUNS888@hotmail.com

邮编：518033 E-mail: szss20@163.com QQ: 195847376

深圳赛格展销部：深圳华强北路赛格电子市场 2583 号 电话：0755-83665529

技术支持：0755-83394033 13501568376

FEATURES

High performance, single/dual axis accelerometer on a single IC chip
5 mm × 5 mm × 2 mm LCC package
1 mg resolution at 60 Hz
Low power: 700 μ A at $V_S = 5 V$ (typical)
High zero g bias stability
High sensitivity accuracy
-40°C to +125°C temperature range
X and Y axes aligned to within 0.1° (typical)
BW adjustment with a single capacitor
Single-supply operation
3500 g shock survival

APPLICATIONS

Vehicle Dynamic Control (VDC)/Electronic Stability Program (ESP) systems
Electronic chassis control
Electronic braking
Platform stabilization/leveling
Navigation
Alarms and motion detectors.
High accuracy, 2-axis tilt sensing

GENERAL DESCRIPTION

The ADXL103/ADXL203 are high precision, low power, complete single and dual axis accelerometers with signal conditioned voltage outputs, all on a single monolithic IC. The ADXL103/ADXL203 measures acceleration with a full-scale range of $\pm 1.7 g$. The ADXL103/ADXL203 can measure both dynamic acceleration (e.g., vibration) and static acceleration (e.g., gravity).

The typical noise floor is $110 \mu g/\sqrt{Hz}$, allowing signals below 1 mg (0.06° of inclination) to be resolved in tilt sensing applications using narrow bandwidths (<60 Hz).

The user selects the bandwidth of the accelerometer using capacitors C_X and C_Y at the X_{OUT} and Y_{OUT} pins. Bandwidths of 0.5 Hz to 2.5 kHz may be selected to suit the application.

The ADXL103 and ADXL203 are available in 5 mm × 5 mm × 2 mm, 8-pad hermetic LCC packages.

FUNCTIONAL BLOCK DIAGRAM

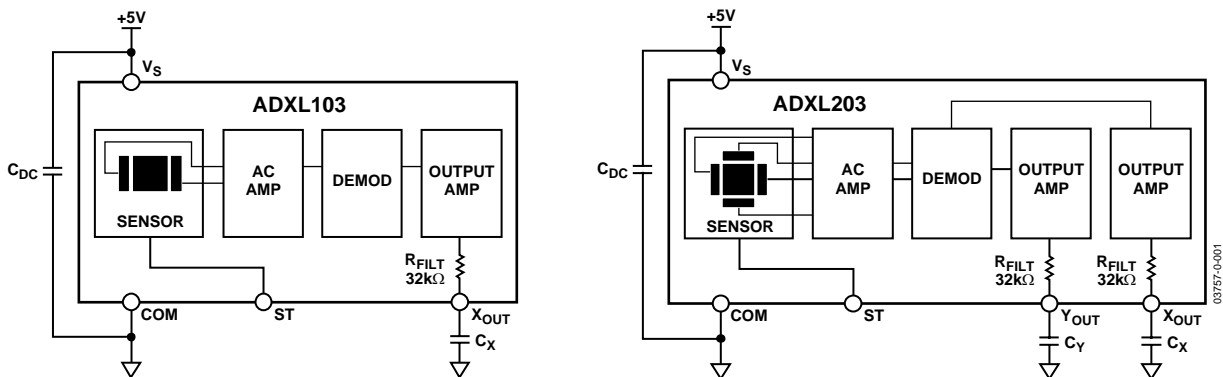

Figure 1. ADXL103/ADXL203 Functional Block Diagram

Rev. 0

Information furnished by Analog Devices is believed to be accurate and reliable. However, no responsibility is assumed by Analog Devices for its use, nor for any infringements of patents or other rights of third parties that may result from its use. Specifications subject to change without notice. No license is granted by implication or otherwise under any patent or patent rights of Analog Devices. Trademarks and registered trademarks are the property of their respective owners.

TABLE OF CONTENTS

| | | | |
|---|---|---|----|
| Specifications..... | 3 | Self Test | 9 |
| Absolute Maximum Ratings..... | 4 | Design Trade-Offs for Selecting Filter Characteristics: The Noise/BW Trade-Off..... | 9 |
| Typical Performance Characteristics | 5 | Using the ADXL103/ADXL203 with Operating Voltages Other than 5 V..... | 10 |
| Theory of Operation | 8 | Using the ADXL203 as a Dual-Axis Tilt Sensor | 10 |
| Performance | 8 | Pin Configurations and Functional Descriptions..... | 11 |
| Applications..... | 9 | Outline Dimensions | 12 |
| Power Supply Decoupling | 9 | Ordering Guide | 12 |
| Setting the Bandwidth Using C_x and C_y | 9 | | |

REVISION HISTORY

Revision 0: Initial Version

SPECIFICATIONS

Table 1. $T_A = -40^{\circ}\text{C}$ to $+125^{\circ}\text{C}$, $V_S = 5\text{ V}$, $C_X = C_Y = 0.1\ \mu\text{F}$, Acceleration = 0 g , unless otherwise noted.

| Parameter | Conditions | Min | Typ | Max | Unit |
|--|--|-----------|-----------|-----------|------------------------------------|
| SENSOR INPUT | Each Axis | | | | |
| Measurement Range ¹ | | ± 1.7 | | | <i>g</i> |
| Nonlinearity | % of Full Scale | | ± 0.5 | ± 2.5 | % |
| Package Alignment Error | | | ± 1 | | Degrees |
| Alignment Error (ADXL203) | X Sensor to Y Sensor | | ± 0.1 | | Degrees |
| Cross Axis Sensitivity | | | ± 2 | ± 5 | % |
| SENSITIVITY (Ratiometric) ² | Each Axis | | | | |
| Sensitivity at X_{OUT} , Y_{OUT} | $V_S = 5\text{ V}$ | 940 | 1000 | 1060 | mV/g |
| Sensitivity Change due to Temperature ³ | $V_S = 5\text{ V}$ | | ± 0.3 | | % |
| ZERO <i>g</i> BIAS LEVEL (Ratiometric) | Each Axis | | | | |
| 0 <i>g</i> Voltage at X_{OUT} , Y_{OUT} | $V_S = 5\text{ V}$ | 2.4 | 2.5 | 2.6 | V |
| Initial 0 <i>g</i> Output Deviation from Ideal | $V_S = 5\text{ V}$, 25°C | | ± 25 | | mg |
| 0 <i>g</i> Offset vs. Temperature | | | ± 0.1 | | mg/ $^{\circ}\text{C}$ |
| NOISE PERFORMANCE | | | | | |
| Output Noise | < 4 kHz, $V_S = 5\text{ V}$, 25°C | | 1 | 6 | mV rms |
| Noise Density | @ 25°C | | 110 | | $\mu\text{g}/\sqrt{\text{Hz}}$ rms |
| FREQUENCY RESPONSE ⁴ | | | | | |
| C_X , C_Y Range ⁵ | | 0.002 | | 10 | μF |
| R_{FILT} Tolerance | | 24 | 32 | 40 | k Ω |
| Sensor Resonant Frequency | | | 5.5 | | kHz |
| SELF TEST ⁶ | | | | | |
| Logic Input Low | | | | 1 | V |
| Logic Input High | | 4 | | | V |
| ST Input Resistance to Ground | | 30 | 50 | | k Ω |
| Output Change at X_{OUT} , Y_{OUT} | Self Test 0 to 1 | 400 | 750 | 1100 | mV |
| OUTPUT AMPLIFIER | | | | | |
| Output Swing Low | No Load | | 0.3 | | V |
| Output Swing High | No Load | | 4.5 | | V |
| POWER SUPPLY | | | | | |
| Operating Voltage Range | | 3 | | 6 | V |
| Quiescent Supply Current | | | 0.7 | 1.1 | mA |
| Turn-On Time ⁷ | | | 20 | | ms |

¹ Guaranteed by measurement of initial offset and sensitivity.

² Sensitivity is essentially ratiometric to V_S . For $V_S = 4.75\text{ V}$ to 5.25 V , sensitivity is 186 mV/V/g to 215 mV/V/g.

³ Defined as the output change from ambient-to-maximum temperature or ambient-to-minimum temperature.

⁴ Actual frequency response controlled by user-supplied external capacitor (C_X , C_Y).

⁵ Bandwidth = $1/(2 \times \pi \times 32\text{ k}\Omega \times C)$. For C_X , $C_Y = 0.002\ \mu\text{F}$, Bandwidth = 2500 Hz. For C_X , $C_Y = 10\ \mu\text{F}$, Bandwidth = 0.5 Hz. Minimum/maximum values are not tested.

⁶ Self-test response changes cubically with V_S .

⁷ Larger values of C_X , C_Y will increase turn-on time. Turn-on time is approximately $160 \times C_X$ or $C_Y + 4\text{ ms}$, where C_X , C_Y are in μF .

All minimum and maximum specifications are guaranteed. Typical specifications are not guaranteed.

ABSOLUTE MAXIMUM RATINGS

Table 2. ADXL103/ADXL203 Stress Ratings

| Parameter | Rating |
|---|---|
| Acceleration (Any Axis, Unpowered) | 3,500 g |
| Acceleration (Any Axis, Powered) | 3,500 g |
| Drop Test (Concrete Surface) | 1.2 m |
| V _s | -0.3 V to +7.0 V |
| All Other Pins | (COM - 0.3 V) to (V _s + 0.3 V) |
| Output Short-Circuit Duration (Any Pin to Common) | Indefinite |
| Operating Temperature Range | -55°C to +125°C |
| Storage Temperature | -65°C to +150°C |

Table 3. Package Characteristics

| Package Type | θ _{JA} | θ _{JC} | Device Weight |
|--------------|-----------------|-----------------|---------------|
| 8-Lead CLCC | 120°C/W | 20°C/W | <1.0 gram |

Stresses above those listed under Absolute Maximum Ratings may cause permanent damage to the device. This is a stress rating only; functional operation of the device at these or any other conditions above those indicated in the operational section of this specification is not implied. Exposure to absolute maximum rating conditions for extended periods may affect device reliability.

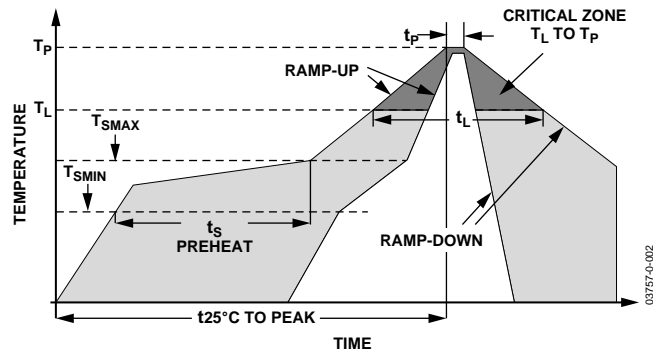

| Profile Feature | Condition | |
|--|-----------------|-----------------|
| | Sn63/Pb37 | Pb Free |
| Average Ramp Rate (T _L to T _P) | 3°C/second Max | |
| Preheat | | |
| • Minimum Temperature (T _{S<sub>MIN</sub>}) | 100°C | 150°C |
| • Minimum Temperature (T _{S<sub>MAX</sub>}) | 150°C | 200°C |
| • Time (T _{S<sub>MIN</sub>} to T _{S<sub>MAX</sub>}) (t _s) | 60-120 seconds | 60-150 seconds |
| T _{S<sub>MAX</sub>} to T _L | | |
| • Ramp-Up Rate | 3°C/second | |
| Time Maintained above Liquidous (T _L) | | |
| • Liquidous Temperature (T _L) | 183°C | 217°C |
| • Time (t _L) | 60-150 seconds | 60-150 seconds |
| Peak Temperature (T _P) | 240°C +0°C/-5°C | 260°C +0°C/-5°C |
| Time within 5°C of Actual Peak Temperature (t _p) | 10-30 seconds | 20-40 seconds |
| Ramp-Down Rate | 6°C/second Max | |
| Time 25°C to Peak Temperature | 6 minutes Max | 8 minutes Max |

Figure 2. Recommended Soldering Profile

TYPICAL PERFORMANCE CHARACTERISTICS

($V_s = 5\text{ V}$ for all graphs, unless otherwise noted.)

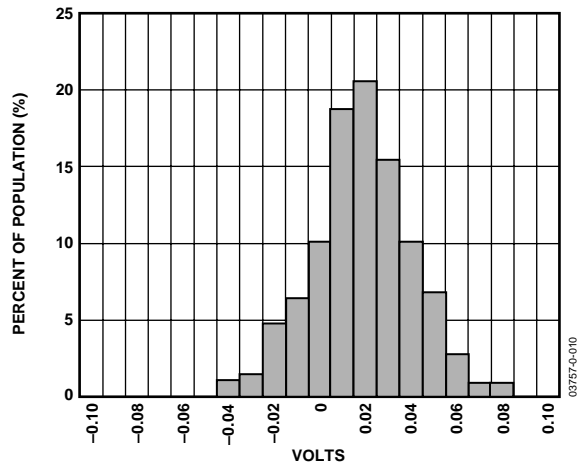

Figure 3. X Axis Zero g Bias Deviation from Ideal at 25°C

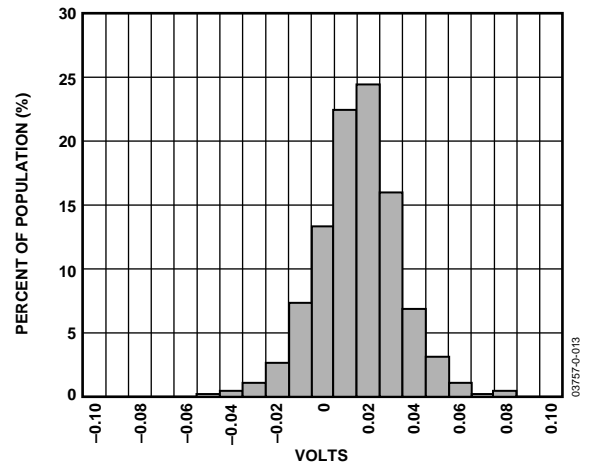

Figure 6. Y Axis Zero g Bias Deviation from Ideal at 25°C

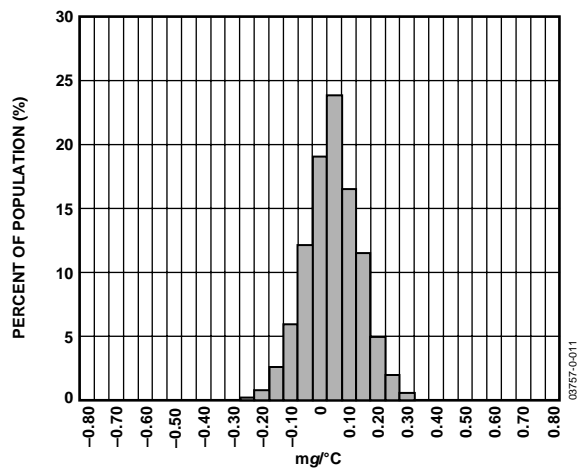

Figure 4. X Axis Zero g Bias Tempco

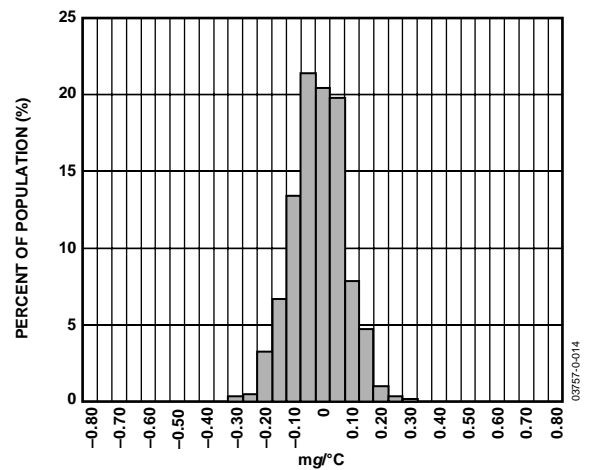

Figure 7. Y Axis Zero g Bias Tempco

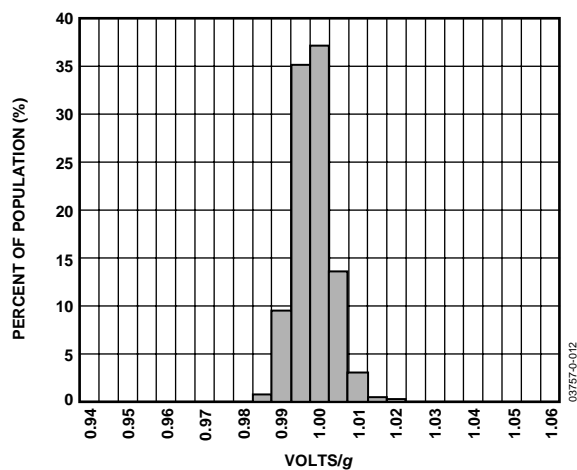

Figure 5. X Axis Sensitivity at 25°C

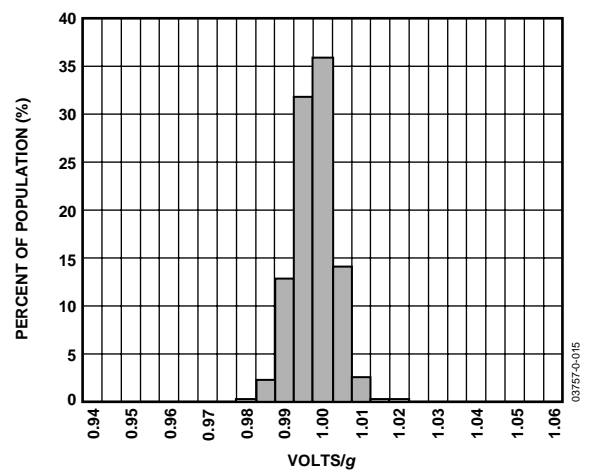

Figure 8. Y Axis Sensitivity at 25°C

ADXL103/ADXL203

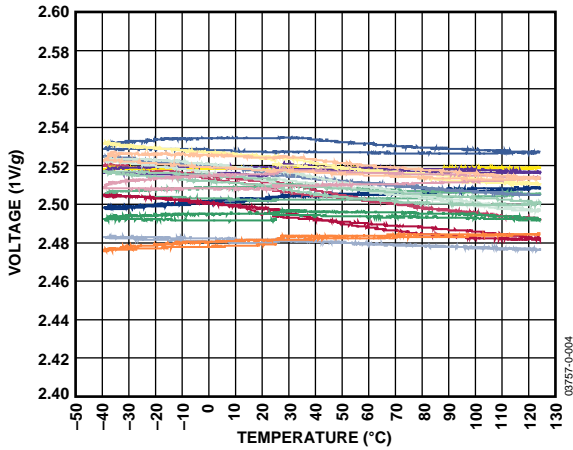

Figure 9. Zero g Bias vs. Temperature – Parts Soldered to PCB

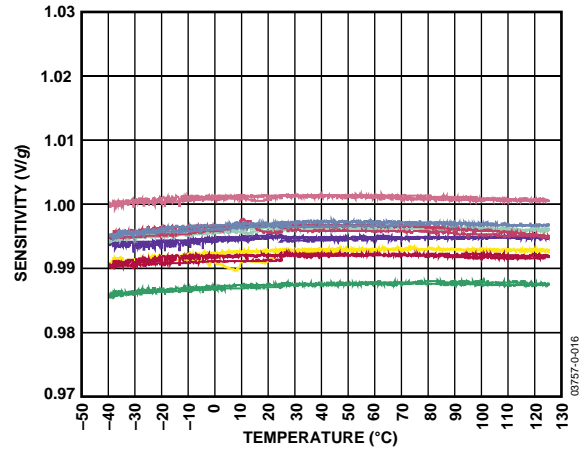

Figure 12. Sensitivity vs. Temperature – Parts Soldered to PCB

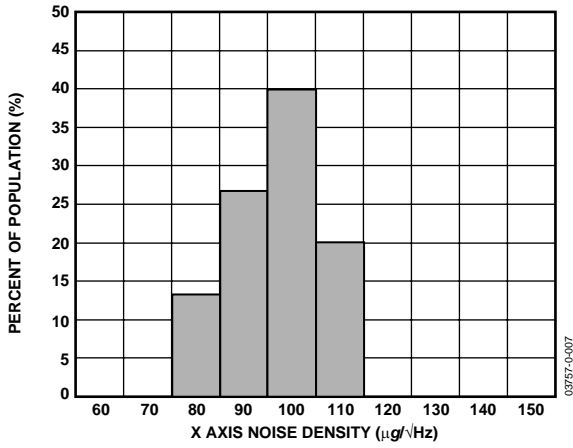

Figure 10. X Axis Noise Density at 25°C

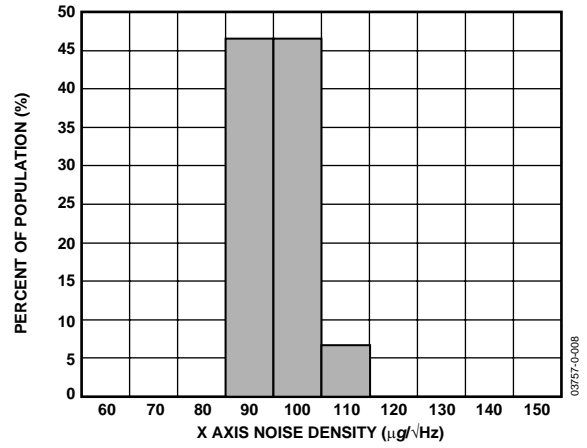

Figure 13. Y Axis Noise Density at 25°C

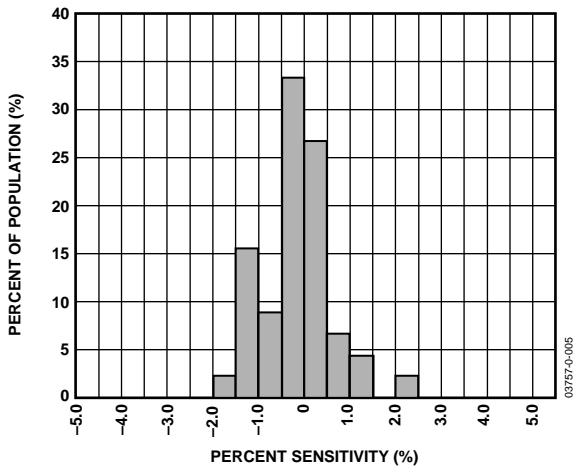

Figure 11. Z vs. X Cross-Axis Sensitivity

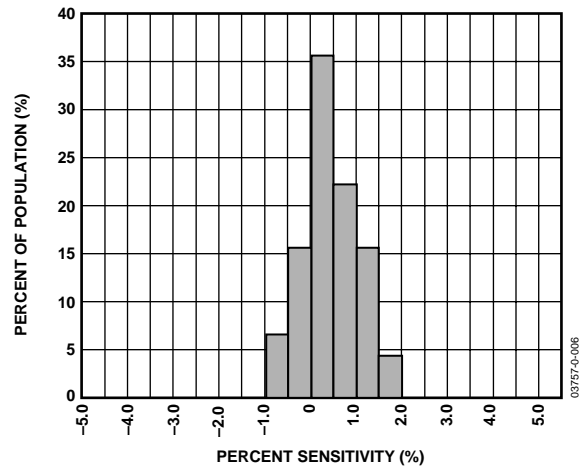

Figure 14. Z vs. Y Cross-Axis Sensitivity

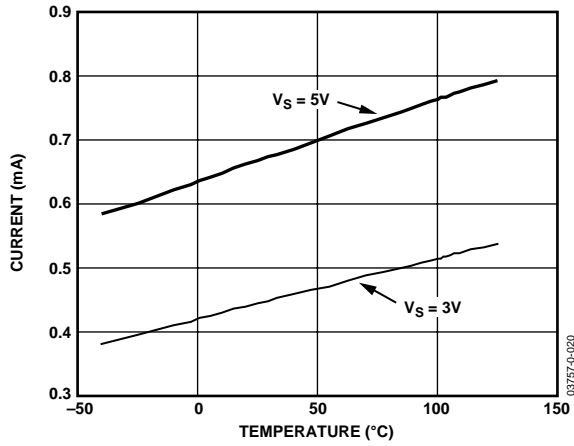

Figure 15. Supply Current vs. Temperature

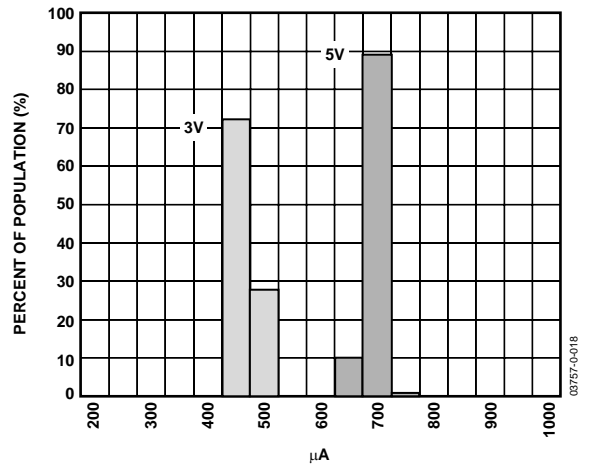

Figure 18. Supply Current at 25°C

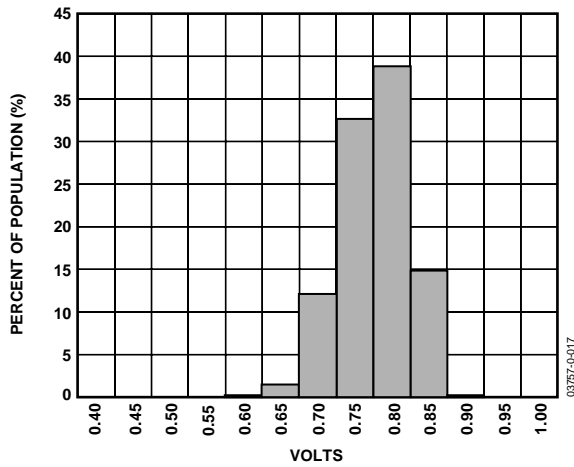

Figure 16. X Axis Self Test Response at 25°C

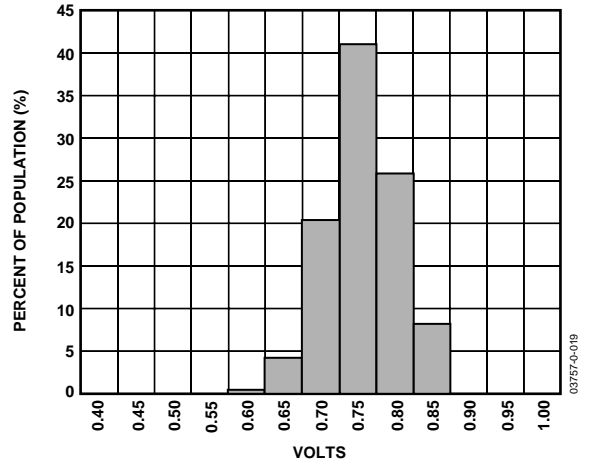

Figure 19. Y Axis Self Test Response at 25°C

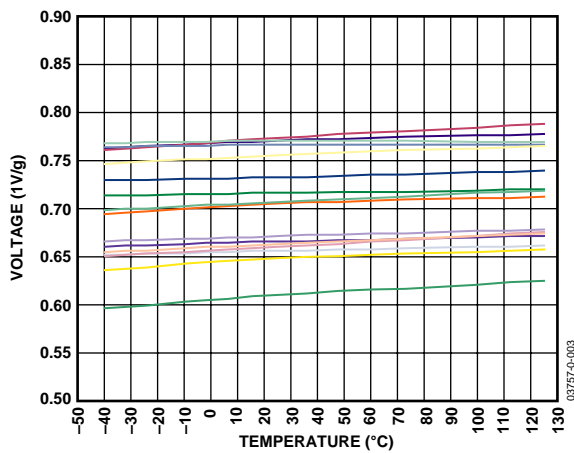

Figure 17. Self Test Response vs. Temperature

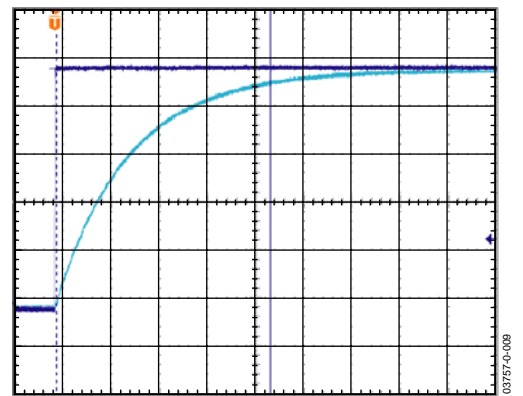

Figure 20. Turn-On Time – $C_x, C_y = 0.1 \mu F$, Time Scale = 2 ms/div

THEORY OF OPERATION

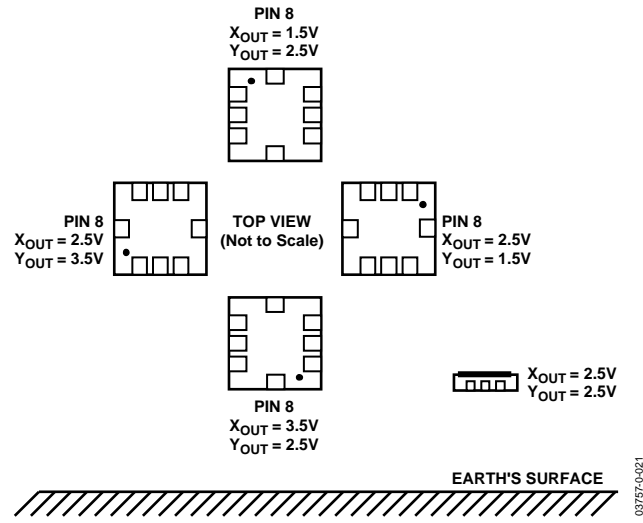

Figure 21. Output Response vs. Orientation

The ADXL103/ADXL203 are complete acceleration measurement systems on a single monolithic IC. The ADXL103 is a single axis accelerometer, while the ADXL203 is a dual axis accelerometer. Both parts contain a polysilicon surface-micromachined sensor and signal conditioning circuitry to implement an open-loop acceleration measurement architecture. The output signals are analog voltages proportional to acceleration. The ADXL103/ADXL203 are capable of measuring both positive and negative accelerations to at least $\pm 1.7 g$. The accelerometer can measure static acceleration forces such as gravity, allowing it to be used as a tilt sensor.

The sensor is a surface-micromachined polysilicon structure built on top of the silicon wafer. Polysilicon springs suspend the structure over the surface of the wafer and provide a resistance against acceleration forces. Deflection of the structure is measured using a differential capacitor that consists of independent fixed plates and plates attached to the moving mass. The fixed plates are driven by 180° out-of-phase square waves. Acceleration will deflect the beam and unbalance the differential capacitor, resulting in an output square wave whose amplitude is proportional to acceleration. Phase sensitive demodulation techniques are then used to rectify the signal and determine the direction of the acceleration.

The output of the demodulator is amplified and brought off-chip through a $32 k\Omega$ resistor. At this point, the user can set the signal bandwidth of the device by adding a capacitor. This filtering improves measurement resolution and helps prevent aliasing.

PERFORMANCE

Rather than using additional temperature compensation circuitry, innovative design techniques have been used to ensure high performance is built in. As a result, there is essentially no quantization error or non-monotonic behavior, and temperature hysteresis is very low (typically less than $10 mg$ over the $-40^\circ C$ to $+125^\circ C$ temperature range).

Figure 9 shows the zero g output performance of eight parts (X and Y axis) over a $-40^\circ C$ to $+125^\circ C$ temperature range.

Figure 12 demonstrates the typical sensitivity shift over temperature for $V_s = 5 V$. Sensitivity stability is optimized for $V_s = 5 V$, but is still very good over the specified range; it is typically better than $\pm 1\%$ over temperature at $V_s = 3 V$.

APPLICATIONS

POWER SUPPLY DECOUPLING

For most applications, a single 0.1 μF capacitor, C_{DC} , will adequately decouple the accelerometer from noise on the power supply. However in some cases, particularly where noise is present at the 140 kHz internal clock frequency (or any harmonic thereof), noise on the supply may cause interference on the ADXL103/ADXL203 output. If additional decoupling is needed, a 100 Ω (or smaller) resistor or ferrite beads may be inserted in the supply line of the ADXL103/ADXL203. Additionally, a larger bulk bypass capacitor (in the 1 μF to 22 μF range) may be added in parallel to C_{DC} .

SETTING THE BANDWIDTH USING C_X AND C_Y

The ADXL103/ADXL203 has provisions for bandlimiting the X_{OUT} and Y_{OUT} pins. Capacitors must be added at these pins to implement low-pass filtering for antialiasing and noise reduction. The equation for the 3 dB bandwidth is

$$F_{-3\text{dB}} = 1/(2\pi(32\text{ k}\Omega) \times C_{(X,Y)})$$

or more simply,

$$F_{-3\text{dB}} = 5\ \mu\text{F}/C_{(X,Y)}$$

The tolerance of the internal resistor (R_{FILT}) can vary typically as much as $\pm 25\%$ of its nominal value (32 k Ω); thus, the bandwidth will vary accordingly. A minimum capacitance of 2000 pF for C_X and C_Y is required in all cases.

Table 4. Filter Capacitor Selection, C_X and C_Y

| Bandwidth (Hz) | Capacitor (μF) |
|----------------|-----------------------------|
| 1 | 4.7 |
| 10 | 0.47 |
| 50 | 0.10 |
| 100 | 0.05 |
| 200 | 0.027 |
| 500 | 0.01 |

SELF TEST

The ST pin controls the self-test feature. When this pin is set to V_S , an electrostatic force is exerted on the beam of the accelerometer. The resulting movement of the beam allows the user to test if the accelerometer is functional. The typical change in output will be 750 mg (corresponding to 750 mV). This pin may be left open-circuit or connected to common in normal use.

The ST pin should never be exposed to voltage greater than $V_S + 0.3\text{ V}$. If the system design is such that this condition cannot be guaranteed (i.e., multiple supply voltages present), a low V_F clamping diode between ST and V_S is recommended.

DESIGN TRADE-OFFS FOR SELECTING FILTER CHARACTERISTICS: THE NOISE/BW TRADE-OFF

The accelerometer bandwidth selected will ultimately determine the measurement resolution (smallest detectable acceleration). Filtering can be used to lower the noise floor, which improves the resolution of the accelerometer. Resolution is dependent on the analog filter bandwidth at X_{OUT} and Y_{OUT} .

The output of the ADXL103/ADXL203 has a typical bandwidth of 2.5 kHz. The user must filter the signal at this point to limit aliasing errors. The analog bandwidth must be no more than half the A/D sampling frequency to minimize aliasing. The analog bandwidth may be further decreased to reduce noise and improve resolution.

The ADXL103/ADXL203 noise has the characteristics of white Gaussian noise, which contributes equally at all frequencies and is described in terms of $\mu\text{g}/\sqrt{\text{Hz}}$ (i.e., the noise is proportional to the square root of the accelerometer's bandwidth). The user should limit bandwidth to the lowest frequency needed by the application in order to maximize the resolution and dynamic range of the accelerometer.

With the single pole roll-off characteristic, the typical noise of the ADXL103/ADXL203 is determined by

$$rmsNoise = (110\mu\text{g}/\sqrt{\text{Hz}}) \times (\sqrt{BW \times 1.6})$$

At 100 Hz, the noise is

$$rmsNoise = (110\mu\text{g}/\sqrt{\text{Hz}}) \times (\sqrt{100 \times 1.6}) = 1.4\text{mg}$$

Often, the peak value of the noise is desired. Peak-to-peak noise can only be estimated by statistical methods. Table 5 is useful for estimating the probabilities of exceeding various peak values, given the rms value.

Table 5. Estimation of Peak-to-Peak Noise

| Peak-to-Peak Value | % of Time That Noise Will Exceed Nominal Peak-to-Peak Value |
|--------------------|---|
| 2 \times RMS | 32 |
| 4 \times RMS | 4.6 |
| 6 \times RMS | 0.27 |
| 8 \times RMS | 0.006 |

ADXL103/ADXL203

Peak-to-peak noise values give the best estimate of the uncertainty in a single measurement. Table 6 gives the typical noise output of the ADXL103/ADXL203 for various C_x and C_y values.

Table 6. Filter Capacitor Selection (C_x , C_y)

| Bandwidth(Hz) | C_x , C_y (μ F) | RMS Noise (mg) | Peak-to-Peak Noise Estimate (mg) |
|---------------|-----------------------------|-------------------|-------------------------------------|
| 10 | 0.47 | 0.4 | 2.6 |
| 50 | 0.1 | 1.0 | 6 |
| 100 | 0.047 | 1.4 | 8.4 |
| 500 | 0.01 | 3.1 | 18.7 |

USING THE ADXL103/ADXL203 WITH OPERATING VOLTAGES OTHER THAN 5 V

The ADXL103/ADXL203 is tested and specified at $V_s = 5$ V; however, it can be powered with V_s as low as 3 V or as high as 6 V. Some performance parameters will change as the supply voltage is varied.

The ADXL103/ADXL203 output is ratiometric, so the output sensitivity (or scale factor) will vary proportionally to supply voltage. At $V_s = 3$ V the output sensitivity is typically 560 mV/g.

The zero g bias output is also ratiometric, so the zero g output is nominally equal to $V_s/2$ at all supply voltages.

The output noise is not ratiometric but is absolute in volts; therefore, the noise density decreases as the supply voltage increases. This is because the scale factor (mV/g) increases while the noise voltage remains constant. At $V_s = 3$ V, the noise density is typically 190 μ g/ $\sqrt{\text{Hz}}$.

Self-test response in g is roughly proportional to the square of the supply voltage. However, when ratiometricity of sensitivity is factored in with supply voltage, self-test response in volts is roughly proportional to the cube of the supply voltage. So at $V_s = 3$ V, the self-test response will be approximately equivalent to 150 mV, or equivalent to 270 mg (typical).

The supply current decreases as the supply voltage decreases. Typical current consumption at $V_{DD} = 3$ V is 450 μ A.

USING THE ADXL203 AS A DUAL-AXIS TILT SENSOR

One of the most popular applications of the ADXL203 is tilt measurement. An accelerometer uses the force of gravity as an input vector to determine the orientation of an object in space.

An accelerometer is most sensitive to tilt when its sensitive axis is perpendicular to the force of gravity, i.e., parallel to the earth's surface. At this orientation, its sensitivity to changes in tilt is highest. When the accelerometer is oriented on axis to gravity, i.e., near its +1 g or -1 g reading, the change in output acceleration per degree of tilt is negligible. When the accelerometer is perpendicular to gravity, its output will change nearly 17.5 mg per degree of tilt. At 45°, its output changes at only 12.2 mg per degree and resolution declines.

Dual-Axis Tilt Sensor: Converting Acceleration to Tilt

When the accelerometer is oriented so both its X axis and Y axis are parallel to the earth's surface, it can be used as a 2-axis tilt sensor with a roll axis and a pitch axis. Once the output signal from the accelerometer has been converted to an acceleration that varies between -1 g and +1 g, the output tilt in degrees is calculated as follows:

$$PITCH = ASIN(A_x/1 g)$$

$$ROLL = ASIN(A_y/1 g)$$

Be sure to account for overranges. It is possible for the accelerometers to output a signal greater than ± 1 g due to vibration, shock, or other accelerations.

PIN CONFIGURATIONS AND FUNCTIONAL DESCRIPTIONS

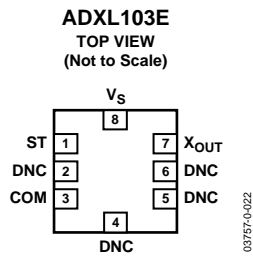

Figure 22. ADXL103 8-Lead CLCC

Table 7. ADXL103 8-Lead CLCC Pin Function Descriptions

| Pin No. | Mnemonic | Description |
|---------|------------------|------------------|
| 1 | ST | Self Test |
| 2 | DNC | Do Not Connect |
| 3 | COM | Common |
| 4 | DNC | Do Not Connect |
| 5 | DNC | Do Not Connect |
| 6 | DNC | Do Not Connect |
| 7 | X _{OUT} | X Channel Output |
| 8 | V _S | 3 V to 6 V |

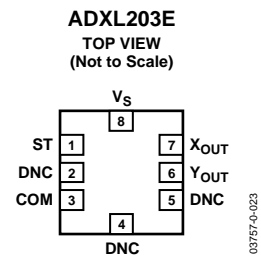

Figure 23. ADXL203 8-Lead CLCC

Table 8. ADXL203 8-Lead CLCC Pin Function Descriptions

| Pin No. | Mnemonic | Description |
|---------|------------------|------------------|
| 1 | ST | Self Test |
| 2 | DNC | Do Not Connect |
| 3 | COM | Common |
| 4 | DNC | Do Not Connect |
| 5 | DNC | Do Not Connect |
| 6 | Y _{OUT} | Y Channel Output |
| 7 | X _{OUT} | X Channel Output |
| 8 | V _S | 3 V to 6 V |

ADXL103/ADXL203

OUTLINE DIMENSIONS

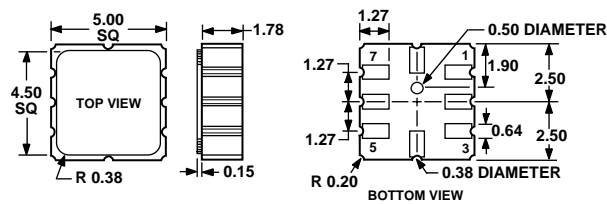

Figure 24. 8-Terminal Ceramic Leadless Chip Carrier [LCC]
(E-8)

Dimensions shown in millimeters

ESD CAUTION

ESD (electrostatic discharge) sensitive device. Electrostatic charges as high as 4000 V readily accumulate on the human body and test equipment and can discharge without detection. Although this product features proprietary ESD protection circuitry, permanent damage may occur on devices subjected to high energy electrostatic discharges. Therefore, proper ESD precautions are recommended to avoid performance degradation or loss of functionality.



ORDERING GUIDE

| ADXL103/ADXL203 Products | Number of Axes | Specified Voltage (V) | Temperature Range | Package Description | Package Option |
|-----------------------------|----------------|-----------------------|-------------------|--------------------------------------|----------------|
| ADXL103CE ¹ | 1 | 5 | -40°C to +125°C | 8-Lead Ceramic Leadless Chip Carrier | E-8 |
| ADXL103CE-REEL ¹ | 1 | 5 | -40°C to +125°C | 8-Lead Ceramic Leadless Chip Carrier | E-8 |
| ADXL203CE ¹ | 2 | 5 | -40°C to +125°C | 8-Lead Ceramic Leadless Chip Carrier | E-8 |
| ADXL203CE-REEL ¹ | 2 | 5 | -40°C to +125°C | 8-Lead Ceramic Leadless Chip Carrier | E-8 |
| ADXL203EB Evaluation Board | | | | Evaluation Board | |

¹ Lead finish—Gold over Nickel over Tungsten.

Copyright © Each Manufacturing Company.

All Datasheets cannot be modified without permission.

This datasheet has been download from :

www.AllDataSheet.com

100% Free DataSheet Search Site.

Free Download.

No Register.

Fast Search System.

www.AllDataSheet.com