



# Low Cost, Ultracompact $\pm 2 g$ Dual-Axis Accelerometer

## ADXL311

### FEATURES

- Low cost
- High resolution
- Dual-axis accelerometer on a single IC chip
- 5 mm  $\times$  5 mm  $\times$  2 mm CLCC package
- Low power < 400  $\mu$ A (typ)
- X-axis and Y-axis aligned to within 0.1° (typ)
- BW adjustment with a single capacitor
- Single-supply operation
- High shock survival

### APPLICATIONS

- Tilt and motion sensing in cost-sensitive applications
- Smart handheld devices
- Computer security
- Input devices
- Pedometers and activity monitors
- Game controllers
- Toys and entertainment products

### GENERAL DESCRIPTION

The ADXL311 is a low cost, low power, complete dual-axis accelerometer with signal conditioned voltage outputs, all on a single monolithic IC. The ADXL311 is built using the same proven iMEMS® process used in over 100 million Analog Devices accelerometers shipped to date, with demonstrated 1 FIT reliability (1 failure per 1 billion device operating hours).

The ADXL311 will measure acceleration with a full-scale range of  $\pm 2 g$ . The ADXL311 can measure both dynamic acceleration (e.g., vibration) and static acceleration (e.g., gravity). The outputs are analog voltages proportional to acceleration.

The typical noise floor is  $300 \mu g/\sqrt{\text{Hz}}$  allowing signals below 2 mg (0.1° of inclination) to be resolved in tilt sensing applications using narrow bandwidths (10 Hz).

The user selects the bandwidth of the accelerometer using capacitors  $C_X$  and  $C_Y$  at the  $X_{\text{FILT}}$  and  $Y_{\text{FILT}}$  pins. Bandwidths of 1 Hz to 2 kHz may be selected to suit the application.

The ADXL311 is available in a 5 mm  $\times$  5 mm  $\times$  2 mm 8-terminal hermetic CLCC package

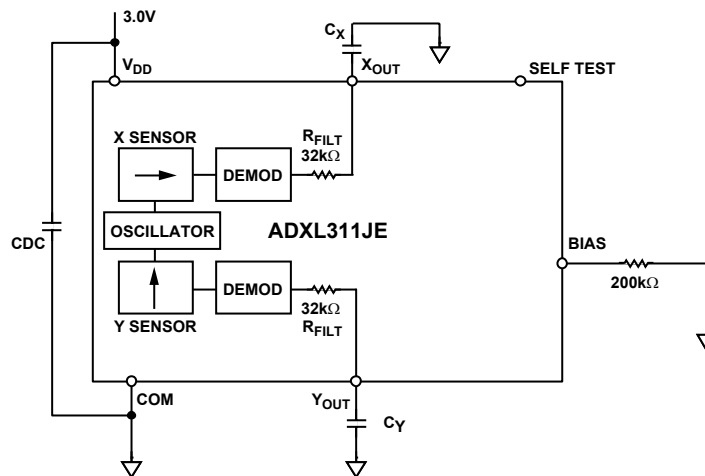

Figure 1. Functional Block Diagram

### Rev. A

Information furnished by Analog Devices is believed to be accurate and reliable. However, no responsibility is assumed by Analog Devices for its use, nor for any infringements of patents or other rights of third parties that may result from its use. Specifications subject to change without notice. No license is granted by implication or otherwise under any patent or patent rights of Analog Devices. Trademarks and registered trademarks are the property of their respective companies.

One Technology Way, P.O. Box 9106, Norwood, MA 02062-9106, U.S.A.  
Tel: 781.329.4700 [www.analog.com](http://www.analog.com)  
Fax: 781.326.8703 © 2003 Analog Devices, Inc. All rights reserved.

# ADXL311

## TABLE OF CONTENTS

Specifications.....	3	Pin Configuration and Functional Descriptions.....	9
Absolute Maximum Ratings.....	4	Outline Dimensions .....	10
Typical Performance Characteristics .....	5	Ordering Guide .....	10
Theory of Operation .....	7		
Applications.....	7		
Design Trade-Offs for Selecting Filter Characteristics: The Noise/BW Trade-Off.....	7		
Using the ADXL311 as a Dual-Axis Tilt Sensor.....	8		

---

## REVISION HISTORY

7/03—Data sheet changed from Rev. 0 to Rev. A. Change to OUTLINE DIMENSIONS.....	10
Revision 0: Initial Version	

## SPECIFICATIONS

**Table 1. T<sub>A</sub> = 25°C, V<sub>DD</sub> = 3 V, R<sub>BIAS</sub> = 125 kΩ, Acceleration = 0 g, unless otherwise noted.)**

Parameter	Conditions	Min	Typ	Max	Units
SENSOR INPUT	Each Axis				
Measurement Range			±2		g
Nonlinearity	Best Fit Straight Line		0.2		% of FS
Alignment Error <sup>1</sup>			±1		Degrees
Alignment Error	X Sensor to Y Sensor		0.01		Degrees
Cross Axis Sensitivity <sup>2</sup>			±2		%
SENSITIVITY	Each Axis				
Sensitivity at X <sub>FILT</sub> , Y <sub>FILT</sub>	V <sub>DD</sub> = 3 V	140	167	195	mV/g
Sensitivity Change due to Temperature <sup>3</sup>	Delta from 25°C		-0.025		%/°C
ZERO g BIAS LEVEL	Each Axis				
0 g Voltage X <sub>FILT</sub> , Y <sub>FILT</sub>	V <sub>DD</sub> = 3 V	1.2	1.5	1.8	V
0 g Offset vs. Temperature	Delta from 25°C		2.0		mg/°C
NOISE PERFORMANCE					
Noise Density	@25°C		300		μg/√Hz RMS
FREQUENCY RESPONSE					
3 dB Bandwidth	At Pins X <sub>FILT</sub> , Y <sub>FILT</sub>		6		kHz
Sensor Resonant Frequency			10		kHz
FILTER					
R <sub>FILT</sub> Tolerance	32 kΩ Nominal		±15		%
Minimum Capacitance	At Pins X <sub>FILT</sub> , Y <sub>FILT</sub>	1000			pF
SELF TEST					
X <sub>FILT</sub> , Y <sub>FILT</sub>	Self Test 0 to 1		45		mV
POWER SUPPLY					
Operating Voltage Range		2.7		5.25	V
Quiescent Supply Current			0.4	1.0	mA
Turn-On Time			160 × C <sub>FILT</sub> + 0.3		ms
TEMPERATURE RANGE					
Operating Range		0		70	°C

<sup>1</sup> Alignment error is specified as the angle between the true and indicated axis of sensitivity (Figure 1).

<sup>2</sup> Cross axis sensitivity is the algebraic sum of the alignment and the inherent sensitivity errors.

<sup>3</sup> Defined as the output change from ambient to maximum temperature or ambient to minimum temperature.

# ADXL311

## ABSOLUTE MAXIMUM RATINGS

**Table 2.**

Parameter	Rating
Acceleration (Any Axis, Unpowered)	3,500 g, 0.5 ms
Acceleration (Any Axis, Powered, $V_{DD} = 3\text{ V}$ )	3,500 g, 0.5 ms
$V_{DD}$	-0.3 V to +0.6 V
Output Short-Circuit Duration, (Any Pin to Commom)	Indefinite
Operating Temperature Range	-55°C to +125°C
Storage Temperature	-65°C to +150°C

Stresses above those listed under Absolute Maximum Ratings may cause permanent damage to the device. This is a stress rating only and functional operation of the device at these or any other conditions above those indicated in the operational section of this specification is not implied. Exposure to absolute maximum rating conditions for extended periods may affect device reliability.

**Table 3. Package Characteristics**

Package Type	$\theta_{JA}$	$\theta_{JC}$	Device Weight
8-Lead CLCC	120°C/W	TBD°C/W	<1.0 gram

## TYPICAL PERFORMANCE CHARACTERISTICS

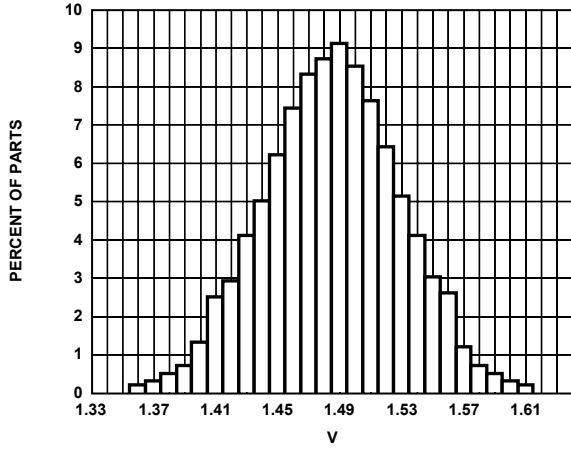

Figure 2. X-Axis Zero g BIAS Output Distribution

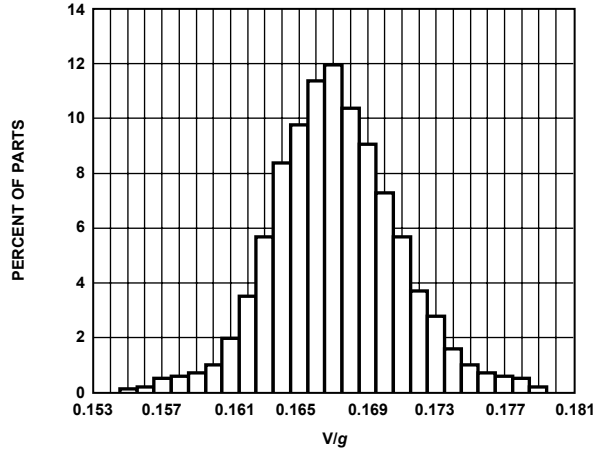

Figure 5. Y-Axis Sensitivity Distribution at  $Y_{OUT}$

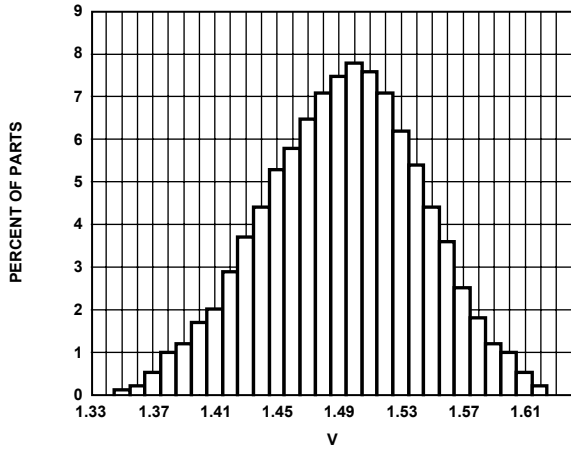

Figure 3. Y-Axis Zero g BIAS Output Distribution

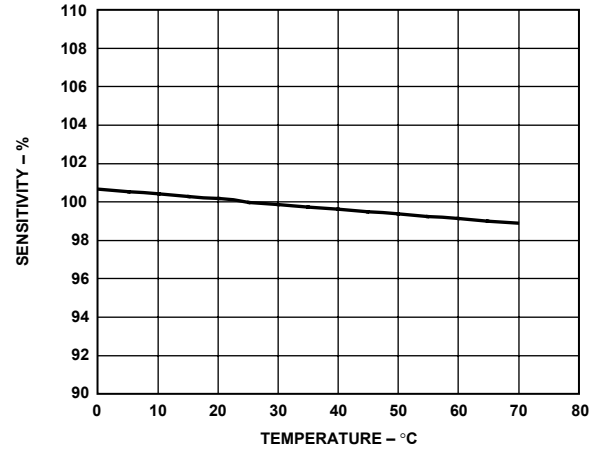

Figure 6. Normalized Sensitivity vs. Temperature

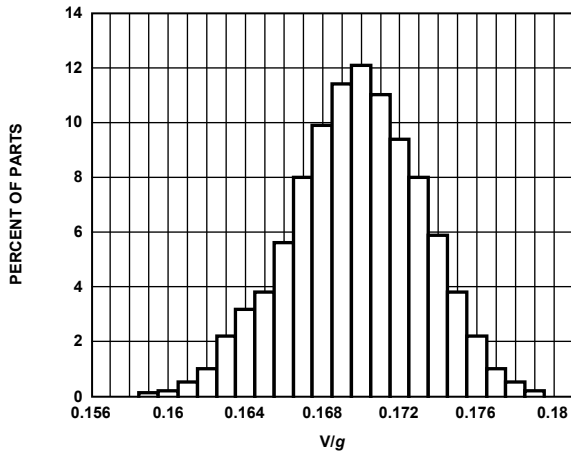

Figure 4. X-Axis Output Sensitivity Distribution at  $X_{OUT}$

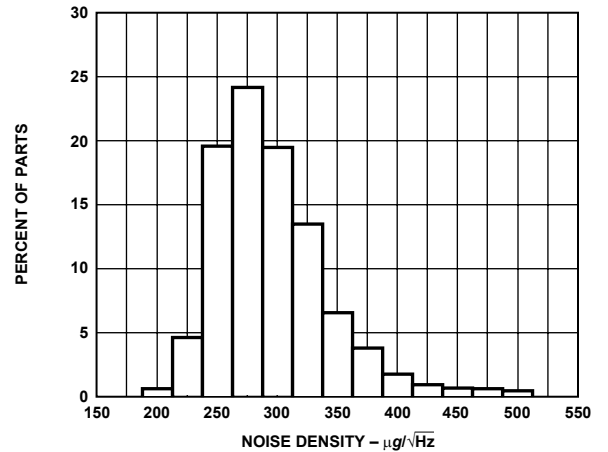

Figure 7. Noise Density Distribution

# ADXL311

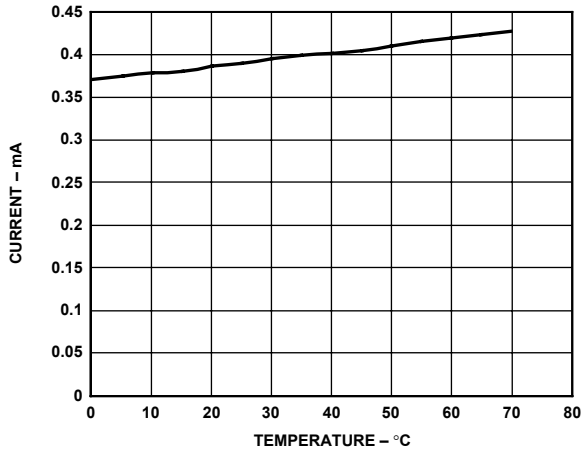

Figure 8. Typical Supply Current vs. Temperature

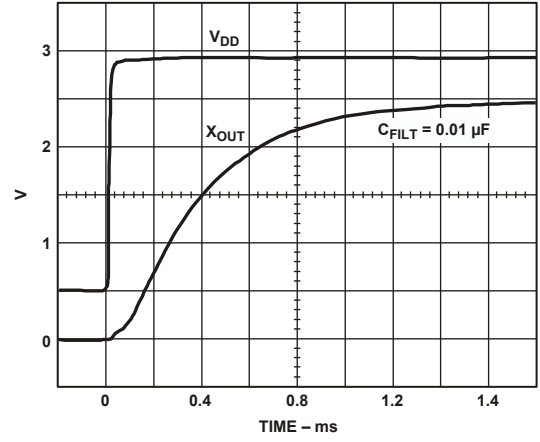

Figure 9. Typical Turn-On Time

## THEORY OF OPERATION

The ADXL311 is a complete, dual-axis acceleration measurement system on a single monolithic IC. It contains a polysilicon surface-micromachined sensor and signal conditioning circuitry to implement an open-loop acceleration measurement architecture. The output signals are analog voltage proportional to acceleration. The ADXL311 is capable of measuring both positive and negative accelerations to at least  $\pm 2 g$ . The accelerometer can measure static acceleration forces, such as gravity, allowing it to be used as a tilt sensor.

The sensor is a surface-micromachined polysilicon structure built on top of the silicon wafer. Polysilicon springs suspend the structure over the surface of the wafer and provide a resistance against acceleration forces. Deflection of the structure is measured using a differential capacitor that consists of independent fixed plates and central plates attached to the moving mass. The fixed plates are driven by  $180^\circ$  out of phase square waves. Acceleration will deflect the beam and unbalance the differential capacitor, resulting in an output square wave whose amplitude is proportional to acceleration. Phase sensitive demodulation techniques are then used to rectify the signal and determine the direction of the acceleration.

The output of the demodulator is amplified and brought off-chip through a  $32\text{ k}\Omega$  resistor. At this point, the user can set the signal bandwidth of the device by adding a capacitor. This filtering improves measurement resolution and helps prevent aliasing.

## Applications

### POWER SUPPLY DECOUPLING

For most applications, a single  $0.1\text{ }\mu\text{F}$  capacitor, CDC, will adequately decouple the accelerometer from noise on the power supply. However, in some cases, particularly where noise is present at the  $100\text{ kHz}$  internal clock frequency (or any harmonic thereof), noise on the supply may cause interference on the ADXL311 output. If additional decoupling is needed, a  $100\text{ }\Omega$  (or smaller) resistor or ferrite beads may be inserted in the supply line of the ADXL311. Additionally, a larger bulk bypass capacitor (in the  $1\text{ }\mu\text{F}$  to  $4.7\text{ }\mu\text{F}$  range) may be added in parallel to CDC.

### SETTING THE BANDWIDTH USING $C_X$ AND $C_Y$

The ADXL311 has provisions for bandlimiting the  $X_{\text{OUT}}$  and  $Y_{\text{OUT}}$  pins. Capacitors must be added at these pins to implement low-pass filtering for antialiasing and noise reduction. The equation for the 3 dB bandwidth is

$$F_{-3dB} = 1 / (2\pi(32\text{ k}\Omega) \times C_{(X,Y)})$$

or, more simply

$$F_{-3dB} = 5\text{ }\mu\text{F} / C_{(X,Y)}$$

The tolerance of the internal resistor ( $R_{\text{FILT}}$ ) can vary typically as much as  $\pm 15\%$  of its nominal value of  $32\text{ k}\Omega$ ; thus, the bandwidth will vary accordingly. A minimum capacitance of  $1000\text{ pF}$  for  $C_X$  and  $C_Y$  is required in all cases.

**Table 4. Filter Capacitor Selection,  $C_X$  and  $C_Y$**

Bandwidth	Capacitor ( $\mu\text{F}$ )
10 Hz	0.47
50 Hz	0.10
100 Hz	0.05
200 Hz	0.027
500 Hz	0.01
5 kHz	0.001

### SELF TEST

The ST pin controls the self-test feature. When this pin is set to  $V_{\text{DD}}$ , an electrostatic force is exerted on the beam of the accelerometer. The resulting movement of the beam allows the user to test if the accelerometer is functional. The typical change in output will be  $270\text{ mg}$  (corresponding to  $45\text{ mV}$ ). This pin may be left open circuit or connected to common in normal use.

### $R_{\text{BIAS}}$ SELECTION

A bias resistor ( $R_{\text{BIAS}}$ ) must always be used. If no resistor is present, the ADXL311 may appear to work but will suffer degraded noise performance. The value of the resistor used is not critical. Any value from  $50\text{ k}\Omega$  to  $2\text{ M}\Omega$  can be used. Using a  $2\text{ M}\Omega$  resistor rather than a  $50\text{ k}\Omega$  will save roughly  $25\text{ }\mu\text{A}$  of supply current.

### Design Trade-Offs for Selecting Filter Characteristics: The Noise/BW Trade-Off

The accelerometer bandwidth selected will ultimately determine the measurement resolution (smallest detectable acceleration). Filtering can be used to lower the noise floor, which improves the resolution of the accelerometer. Resolution is dependent on the analog filter bandwidth at  $X_{\text{OUT}}$  and  $Y_{\text{OUT}}$ .

The output of the ADXL311 has a typical bandwidth of  $5\text{ kHz}$ . The user must filter the signal at this point to limit aliasing errors. The analog bandwidth must be no more than half the A/D sampling frequency to minimize aliasing. The analog bandwidth may be further decreased to reduce noise and improve resolution.

The ADXL311 noise has the characteristics of white Gaussian noise that contributes equally at all frequencies and is described in terms of  $\mu\text{g}/\sqrt{\text{Hz}}$ , i.e., the noise is proportional to the square

# ADXL311

root of the bandwidth of the accelerometer. It is recommended that the user limit bandwidth to the lowest frequency needed by the application, to maximize the resolution and dynamic range of the accelerometer.

With the single pole roll-off characteristic, the typical noise of the ADXL202E is determined by

$$RMS\ NOISE = (300\ \mu g / \sqrt{Hz}) \times (\sqrt{BW} \times 1.6)$$

At 100 Hz the noise will be

$$RMS\ NOISE = (300\ \mu g / \sqrt{Hz}) \times (\sqrt{100} \times 1.6) = 3.8\ mg$$

Often the peak value of the noise is desired. Peak-to-peak noise can only be estimated by statistical methods. Table 5 is useful for estimating the probabilities of exceeding various peak values, given the rms value.

**Table 5. Estimation of Peak-to-Peak Noise**

Peak-to-Peak Value	% of Time That Noise Will Exceed Nominal Peak-to-Peak Value
2 × RMS	32
4 × RMS	4.6
6 × RMS	0.27
8 × RMS	0.006

The peak-to-peak noise value will give the best estimate of the uncertainty in a single measurement. Table 6 gives the typical noise output of the ADXL311 for various  $C_x$  and  $C_y$  values.

**Table 6. Filter Capacitor Selection ( $C_x$ ,  $C_y$ )**

Bandwidth (Hz)	$C_x$ , $C_y$ ( $\mu F$ )	RMS Noise (mg)	Peak-to-Peak Noise Estimate (mg)
10	0.47	1.2	7.2
50	0.1	2.7	16.2
100	0.047	3.8	22.8
500	0.01	8.5	51

## USING THE ADXL311 WITH OPERATING VOLTAGES OTHER THAN 3 V

The ADXL311 is tested and specified at  $V_{DD} = 3\ V$ ; however, it can be powered with  $V_{DD}$  as low as 2.7 V or as high as 5.25 V. Some performance parameters will change as the supply voltage is varied.

The ADXL311 output is ratiometric, so the output sensitivity (or scale factor) will vary proportionally to supply voltage. At  $V_{DD} = 5\ V$  the output sensitivity is typically 312 mV/g.

The zero  $g$  bias output is also ratiometric, so the zero  $g$  output is nominally equal to  $V_{DD}/2$  at all supply voltages.

The output noise is not ratiometric but absolute in volts; therefore, the noise density decreases as the supply voltage increases. This is because the scale factor (mV/g) increases while the noise voltage remains constant.

The self-test response is roughly proportional to the square of the supply voltage. At  $V_{DD} = 5\ V$ , the self-test response will be approximately equivalent to 800 mg (typical).

The supply current increases as the supply voltage increases. Typical current consumption at  $V_{DD} = 5\ V$  is 600  $\mu A$ .

## Using the ADXL311 as a Dual-Axis Tilt Sensor

One of the most popular applications of the ADXL311 is tilt measurement. An accelerometer uses the force of gravity as an input vector to determine the orientation of an object in space.

An accelerometer is most sensitive to tilt when its sensitive axis is perpendicular to the force of gravity, i.e., parallel to the earth's surface. At this orientation, its sensitivity to changes in tilt is highest. When the accelerometer is oriented on axis to gravity, i.e., near its +1  $g$  or -1  $g$  reading, the change in output acceleration per degree of tilt is negligible. When the accelerometer is perpendicular to gravity, its output will change nearly 17.5 mg per degree of tilt, but at 45° degrees, it is changing only at 12.2 mg per degree and resolution declines.

## DUAL-AXIS TILT SENSOR: CONVERTING ACCELERATION TO TILT

When the accelerometer is oriented so both its X-axis and Y-axis are parallel to the earth's surface, it can be used as a two axis tilt sensor with a roll axis and a pitch axis. Once the output signal from the accelerometer has been converted to an acceleration that varies between -1  $g$  and +1  $g$ , the output tilt in degrees is calculated as follows:

$$PITCH = ASIN(A_X / 1\ g)$$

$$ROLL = ASIN(A_Y / 1\ g)$$

Be sure to account for overranges. It is possible for the accelerometers to output a signal greater than  $\pm 1\ g$  due to vibration, shock, or other accelerations.



## PIN CONFIGURATION AND FUNCTIONAL DESCRIPTIONS

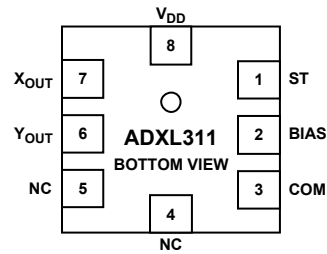

Figure 10. 8-Lead CLCC

**Table 7. Pin Function Descriptions—8-Lead CLCC**

Pin No.	Mnemonic	Description
1	ST	Self Test
2	BIAS	Bias Resistor ( $\approx 200\text{ k}\Omega$ )
3	COM	Common
4	NC	Do Not Connect
5	NC	Do Not Connect
6	Y <sub>OUT</sub>	Y Channel Output
7	X <sub>OUT</sub>	X Channel Output
8	V <sub>DD</sub>	2.7 V to 5.25 V

# ADXL311

## OUTLINE DIMENSIONS

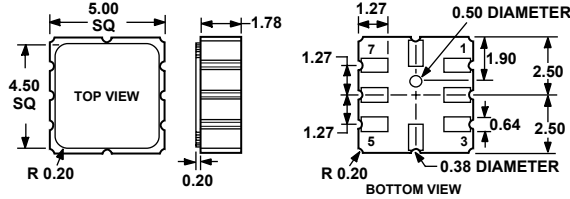

Figure 11. 8-Terminal Ceramic Leadless Chip Carrier [CLCC]  
(E-8)  
Dimensions shown in millimeters

### ESD CAUTION

ESD (electrostatic discharge) sensitive device. Electrostatic charges as high as 4000 V readily accumulate on the human body and test equipment and can discharge without detection. Although this product features proprietary ESD protection circuitry, permanent damage may occur on devices subjected to high energy electrostatic discharges. Therefore, proper ESD precautions are recommended to avoid performance degradation or loss of functionality.



### Ordering Guide

ADXL311Products	Number of Axes	Specified Voltage	Temperature Range
ADXL311JE	2	3 V	0°C to 70°C
ADXL311JE-REEL	2	3 V	0°C to 70°C
ADXL311EB Evaluation Board			

**NOTES**

# ADXL311

## NOTES

SUNSTAR商斯达实业集团是集研发、生产、工程、销售、代理经销、技术咨询、信息服务等为一体的高科技企业，是专业高科技电子产品生产厂家，是具有 10 多年历史的专业电子元器件供应商，是中国最早和最大的仓储式连锁规模经营大型综合电子零部件代理分销商之一，是一家专业代理和分销世界各大品牌 IC 芯片和电子元器件的连锁经营综合性国际公司。在香港、北京、深圳、上海、西安、成都等全国主要电子市场设有直属分公司和产品展示展销窗口门市部专卖店及代理分销商，已在全国范围内建成强大统一的供货和代理分销网络。我们专业代理经销、开发生产电子元器件、集成电路、传感器、微波光电元器件、工控机/DOC/DOM 电子盘、专用电路、单片机开发、MCU/DSP/ARM/FPGA 软件硬件、二极管、三极管、模块等，是您可靠的一站式现货配套供应商、方案提供商、部件功能模块开发配套商。专业以现代信息产业（计算机、通讯及传感器）三大支柱之一的传感器为主营业务，专业经营各类传感器的代理、销售生产、网络信息、科技图书资料及配套产品设计、工程开发。我们的专业网站——中国传感器科技信息网（全球传感器数据库）[www.SENSOR-IC.COM](http://www.SENSOR-IC.COM) 服务于全球高科技生产商及贸易商，为企业科技产品开发提供技术交流平台。欢迎各厂商互通有无、交换信息、交换链接、发布寻求代理信息。欢迎国外高科技传感器、变送器、执行器、自动控制产品厂商介绍产品到中国，共同开拓市场。本网站是关于各种传感器-变送器-仪器仪表及工业自动化大型专业网站，深入到工业控制、系统工程计 测量、自动化、安防报警、消费电子等众多领域，把最新的传感器-变送器-仪器仪表买卖信息，最新技术供求，最新采购商，行业动态，发展方向，最新的技术应用和市场资讯及时的传递给广大科技开发、科学研究、产品设计人员。本网站已成功为石油、化工、电力、医药、生物、航空、航天、国防、能源、冶金、电子、工业、农业、交通、汽车、矿山、煤炭、纺织、信息、通信、IT、安防、环保、印刷、科研、气象、仪器仪表等领域从事科学研究、产品设计、开发、生产制造的科技人员、管理人员、和采购人员提供满意服务。我们公司专业生产、代理、经销、销售各种传感器、变送器、敏感元器件、开关、执行器、仪器仪表、自动化控制系统：专业从事设计、生产、销售各种传感器、变送器、各种测控仪表、热工仪表、现场控制器、计算机控制系统、数据采集系统、各类环境监控系统、专用控制系统应用软件以及嵌入式系统开发及应用等工作。如热敏电阻、压敏电阻、温度传感器、温度变送器、湿度传感器、湿度变送器、气体传感器、气体变送器、压力传感器、压力变送、称重传感器、物（液）位传感器、物（液）位变送器、流量传感器、流量变送器、电流（压）传感器、溶氧传感器、霍尔传感器、图像传感器、超声波传感器、位移传感器、速度传感器、加速度传感器、扭距传感器、红外传感器、紫外传感器、火焰传感器、激光传感器、振动传感器、轴角传感器、光电传感器、接近传感器、干簧管传感器、继电器传感器、微型电泵、磁敏（阻）传感器、压力开关、接近开关、光电开关、色标传感器、光纤传感器、齿轮测速传感器、时间继电器、计数器、计米器、温控仪、固态继电器、调压模块、电磁铁、电压表、电流表等特殊传感器。同时承接传感器应用电路、产品设计和自动化工程项目。

更多产品请看本公司产品专用销售网站：

商斯达中国传感器科技信息网：<http://www.sensor-ic.com/>

商斯达工控安防网：<http://www.pc-ps.net/>

商斯达电子元器件网：<http://www.sunstare.com/>

商斯达微波光电产品网：[HTTP://www.rfoe.net/](http://www.rfoe.net/)

商斯达消费电子产品网：<http://www.icasic.com/>

商斯达军工产品网：<http://www.junpinic.com/>

商斯达实业科技产品网：<http://www.sunstars.cn/> 传感器销售热线：

地址：深圳市福田区福华路福庆街鸿图大厦 1602 室

电话：0755-83607652 83376489 83376549 83370250 83370251 82500323

传真：0755-83376182 (0) 13902971329 MSN: [SUNS888@hotmail.com](mailto:SUNS888@hotmail.com)

邮编：518033 E-mail: [szss20@163.com](mailto:szss20@163.com) QQ: 195847376

深圳赛格展销部：深圳华强北路赛格电子市场 2583 号 电话：0755-83665529 25059422

技术支持：0755-83394033 13501568376

欢迎索取免费详细资料、设计指南和光盘；产品凡多，未能尽录，欢迎来电查询。

北京分公司：北京海淀区知春路 132 号中发电子大厦 3097 号

TEL: 010-81159046 82615020 13501189838 FAX: 010-62543996

上海分公司：上海市北京东路 668 号上海赛格电子市场 D125 号

TEL: 021-28311762 56703037 13701955389 FAX: 021-56703037

西安分公司：西安高新开发区 20 所(中国电子科技集团导航技术研究所)

西安劳动南路 88 号电子商城二楼 D23 号

TEL: 029-81022619 13072977981 FAX:029-88789382