

SUNSTAR商斯达实业集团是集研发、生产、工程、销售、代理经销、技术咨询、信息服务等为一体的高科技企业，是专业高科技电子产品生产厂家，是具有10多年历史的专业电子元器件供应商，是中国最早和最大的仓储式连锁规模经营大型综合电子零部件代理分销商之一，是一家专业代理和分销世界各大品牌IC芯片和电子元器件的连锁经营综合性国际公司。在香港、北京、深圳、上海、西安、成都等全国主要电子市场设有直属分公司和产品展示展销窗口门市部专卖店及代理分销商，已在全国范围内建成强大统一的供货和代理分销网络。我们专业代理经销、开发生产电子元器件、集成电路、传感器、微波光电元器件、工控机/DOC/DOM电子盘、专用电路、单片机开发、MCU/DSP/ARM/FPGA软件硬件、二极管、三极管、模块等，是您可靠的一站式现货配套供应商、方案提供商、部件功能模块开发配套商。专业以现代信息产业（计算机、通讯及传感器）三大支柱之一的传感器为主营业务，专业经营各类传感器的代理、销售生产、网络信息、科技图书资料及配套产品设计、工程开发。我们的专业网站——中国传感器科技信息网（全球传感器数据库）www.SENSOR-IC.COM 服务于全球高科技生产商及贸易商，为企业科技产品开发提供技术交流平台。欢迎各厂商互通有无、交换信息、交换链接、发布寻求代理信息。欢迎国外高科技传感器、变送器、执行器、自动控制产品厂商介绍产品到中国，共同开拓市场。本网站是关于各种传感器-变送器-仪器仪表及工业自动化大型专业网站，深入到工业控制、系统工程计 测量、自动化、安防报警、消费电子等众多领域，把最新的传感器-变送器-仪器仪表买卖信息，最新技术供求，最新采购商，行业动态，发展方向，最新的技术应用和市场资讯及时的传递给广大科技开发、科学研究、产品设计人员。本网站已成功为石油、化工、电力、医药、生物、航空、航天、国防、能源、冶金、电子、工业、农业、交通、汽车、矿山、煤炭、纺织、信息、通信、IT、安防、环保、印刷、科研、气象、仪器仪表等领域从事科学研究、产品设计、开发、生产制造的科技人员、管理人员、和采购人员提供满意服务。我公司专业生产、代理、经销、销售各种传感器、变送器、敏感元器件、开关、执行器、仪器仪表、自动化控制系统：专门从事设计、生产、销售各种传感器、变送器、各种测控仪表、热工仪表、现场控制器、计算机控制系统、数据采集系统、各类环境监控系统、专用控制系统应用软件以及嵌入式系统开发及应用等工作。如热敏电阻、压敏电阻、温度传感器、温度变送器、湿度传感器、湿度变送器、气体传感器、气体变送器、压力传感器、压力变送、称重传感器、物（液）位传感器、物（液）位变送器、流量传感器、流量变送器、电流（压）传感器、溶氧传感器、霍尔传感器、图像传感器、超声波传感器、位移传感器、速度传感器、加速度传感器、扭距传感器、红外传感器、紫外传感器、火焰传感器、激光传感器、振动传感器、轴角传感器、光电传感器、接近传感器、簧管传感器、继电器传感器、微型电泵、磁敏（阻）传感器、压力开关、接近开关、光电开关、色标传感器、光纤传感器、齿轮测速传感器、时间继电器、计数器、计米器、温控仪、固态继电器、调压模块、电磁铁、电压表、电流表等特殊传感器。同时承接传感器应用电路、产品设计和自动化工程项目。

欢迎索取免费详细资料、设计指南和光盘；产品凡多，未能尽录，欢迎来电查询。

更多产品请看本公司产品专用销售网站：

商斯达中国传感器科技信息网：<http://www.sensor-ic.com/>

商斯达工控安防网：<http://www.pc-ps.net/>

商斯达电子元器件网：<http://www.sunstare.com/>

商斯达微波光电产品网：[HTTP://www.rfoe.net/](http://www.rfoe.net/)

商斯达消费电子产品网：<http://www.icasic.com/>

商斯达军工产品网：<http://www.junpinic.com/>

商斯达实业科技产品网：<http://www.sunstars.cn/>传感器销售热线：

地址：深圳市福田区福华路福庆街鸿图大厦1602室

电话：0755-83607652 83376489 83376549 83370250 83370251 82500323

传真：0755-83376182 (0) 13902971329 MSN: SUNS888@hotmail.com

邮编：518033 E-mail: szss20@163.com QQ: 195847376

深圳赛格展销部：深圳华强北路赛格电子市场2583号 电话：0755-83665529

技术支持：0755-83394033 13501568376



Small, Low Power, 3-Axis $\pm 3 g$ *i*MEMS[®] Accelerometer

ADXL330

FEATURES

- 3-axis sensing
- Small, low-profile package
 - 4 mm × 4 mm × 1.45 mm LFCSP
- Low power
 - 200 μ A at $V_s = 2.0$ V (typical)
- Single-supply operation
 - 2.0 V to 3.6 V
- 10,000 g shock survival
- Excellent temperature stability
- BW adjustment with a single capacitor per axis
- RoHS/WEEE lead-free compliant

APPLICATIONS

- Cost-sensitive, low power, motion- and tilt-sensing applications
 - Mobile devices
 - Gaming systems
 - Disk drive protection
 - Image stabilization
 - Sports and health devices

GENERAL DESCRIPTION

The ADXL330 is a small, thin, low power, complete three axis accelerometer with signal conditioned voltage outputs, all on a single monolithic IC. The product measures acceleration with a minimum full-scale range of $\pm 3 g$. It can measure the static acceleration of gravity in tilt-sensing applications, as well as dynamic acceleration resulting from motion, shock, or vibration.

The user selects the bandwidth of the accelerometer using the C_x , C_y , and C_z capacitors at the X_{OUT} , Y_{OUT} , and Z_{OUT} pins. Bandwidths can be selected to suit the application, with a range of 0.5 Hz to 1,600 Hz for X and Y axes, and a range of 0.5 Hz to 550 Hz for the Z axis.

The ADXL330 is available in a small, low-profile, 4 mm × 4 mm × 1.45 mm, 16-lead, plastic lead frame chip scale package (LFCSP_LQ).

FUNCTIONAL BLOCK DIAGRAM

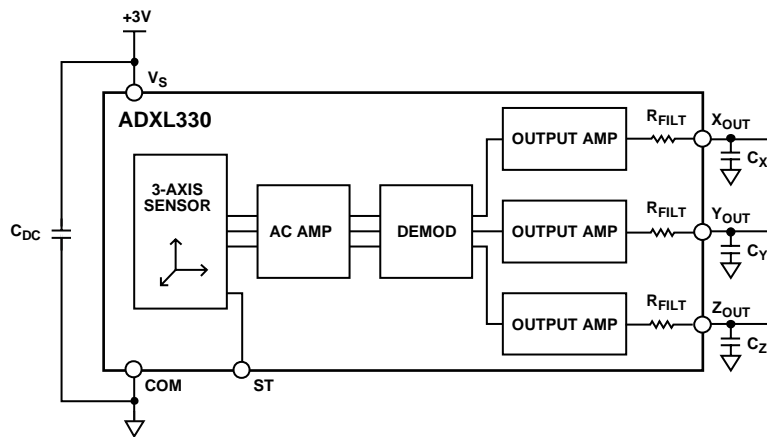

Figure 1.

Rev. 0

Information furnished by Analog Devices is believed to be accurate and reliable. However, no responsibility is assumed by Analog Devices for its use, nor for any infringements of patents or other rights of third parties that may result from its use. Specifications subject to change without notice. No license is granted by implication or otherwise under any patent or patent rights of Analog Devices. Trademarks and registered trademarks are the property of their respective owners.

One Technology Way, P.O. Box 9106, Norwood, MA 02062-9106, U.S.A.
Tel: 781.329.4700 www.analog.com

Fax: 781.461.3113 ©2006 Analog Devices, Inc. All rights reserved.

ADXL330

TABLE OF CONTENTS

Features	1	Performance	11
Applications.....	1	Applications.....	12
General Description	1	Power Supply Decoupling	12
Functional Block Diagram	1	Setting the Bandwidth Using C_x , C_y and C_z	12
Revision History	2	Self-Test	12
Specifications.....	3	Design Trade-Offs for Selecting Filter Characteristics: The Noise/BW Trade-Off.....	12
Absolute Maximum Ratings.....	4	Use with Operating Voltages Other than 3 V.....	12
ESD Caution.....	4	Axes of Acceleration Sensitivity	13
Pin Configuration and Function Descriptions.....	5	Outline Dimensions	14
Typical Performance Characteristics	6	Ordering Guide	14
Theory of Operation	11		
Mechanical Sensor.....	11		

REVISION HISTORY

3/06—Revision 0: Initial Version

SPECIFICATIONS

$T_A = 25^\circ\text{C}$, $V_S = 3\text{ V}$, $C_X = C_Y = C_Z = 0.1\ \mu\text{F}$, acceleration = 0 g, unless otherwise noted. All minimum and maximum specifications are guaranteed. Typical specifications are not guaranteed.

Table 1.

Parameter	Conditions	Min	Typ	Max	Unit
SENSOR INPUT					
Measurement Range	Each axis	± 3	± 3.6		g
Nonlinearity	% of full scale		± 0.3		%
Package Alignment Error			± 1		Degrees
Inter-Axis Alignment Error			± 0.1		Degrees
Cross Axis Sensitivity ¹			± 1		%
SENSITIVITY (RATIOMETRIC)²					
Sensitivity at X_{OUT} , Y_{OUT} , Z_{OUT}	$V_S = 3\text{ V}$	270	300	330	mV/g
Sensitivity Change Due to Temperature ³	$V_S = 3\text{ V}$		± 0.015		%/ $^\circ\text{C}$
ZERO g BIAS LEVEL (RATIOMETRIC)					
0 g Voltage at X_{OUT} , Y_{OUT} , Z_{OUT}	$V_S = 3\text{ V}$	1.2	1.5	1.8	V
0 g Offset vs. Temperature			± 1		mg/ $^\circ\text{C}$
NOISE PERFORMANCE					
Noise Density X_{OUT} , Y_{OUT}			280		$\mu\text{g}/\sqrt{\text{Hz}}$ rms
Noise Density Z_{OUT}			350		$\mu\text{g}/\sqrt{\text{Hz}}$ rms
FREQUENCY RESPONSE⁴					
Bandwidth X_{OUT} , Y_{OUT} ⁵	No external filter		1600		Hz
Bandwidth Z_{OUT} ⁵	No external filter		550		Hz
R_{FILT} Tolerance			$32 \pm 15\%$		k Ω
Sensor Resonant Frequency			5.5		kHz
SELF-TEST⁶					
Logic Input Low			+0.6		V
Logic Input High			+2.4		V
ST Actuation Current			+60		μA
Output Change at X_{OUT}	Self-test 0 to 1		-150		mV
Output Change at Y_{OUT}	Self-test 0 to 1		+150		mV
Output Change at Z_{OUT}	Self-test 0 to 1		-60		mV
OUTPUT AMPLIFIER					
Output Swing Low	No load		0.1		V
Output Swing High	No load		2.8		V
POWER SUPPLY					
Operating Voltage Range		2.0		3.6	V
Supply Current	$V_S = 3\text{ V}$		320		μA
Turn-On Time ⁷	No external filter		1		ms
TEMPERATURE					
Operating Temperature Range		-25		+70	$^\circ\text{C}$

¹ Defined as coupling between any two axes.

² Sensitivity is essentially ratiometric to V_S .

³ Defined as the output change from ambient-to-maximum temperature or ambient-to-minimum temperature.

⁴ Actual frequency response controlled by user-supplied external filter capacitors (C_X , C_Y , C_Z).

⁵ Bandwidth with external capacitors = $1/(2 \times \pi \times 32\text{ k}\Omega \times C)$. For C_X , $C_Y = 0.003\ \mu\text{F}$, bandwidth = 1.6 kHz. For $C_Z = 0.01\ \mu\text{F}$, bandwidth = 500 Hz. For C_X , C_Y , $C_Z = 10\ \mu\text{F}$, bandwidth = 0.5 Hz.

⁶ Self-test response changes cubically with V_S .

⁷ Turn-on time is dependent on C_X , C_Y , C_Z and is approximately $160 \times C_X$ or C_Y or $C_Z + 1\text{ ms}$, where C_X , C_Y , C_Z are in μF .

ADXL330

ABSOLUTE MAXIMUM RATINGS

Table 2.

Parameter	Rating
Acceleration (Any Axis, Unpowered)	10,000 g
Acceleration (Any Axis, Powered)	10,000 g
V_s	-0.3 V to +7.0 V
All Other Pins	(COM - 0.3 V) to ($V_s + 0.3 V$)
Output Short-Circuit Duration (Any Pin to Common)	Indefinite
Temperature Range (Powered)	-55°C to +125°C
Temperature Range (Storage)	-65°C to +150°C

Stresses above those listed under Absolute Maximum Ratings may cause permanent damage to the device. This is a stress rating only; functional operation of the device at these or any other conditions above those indicated in the operational section of this specification is not implied. Exposure to absolute maximum rating conditions for extended periods may affect device reliability.

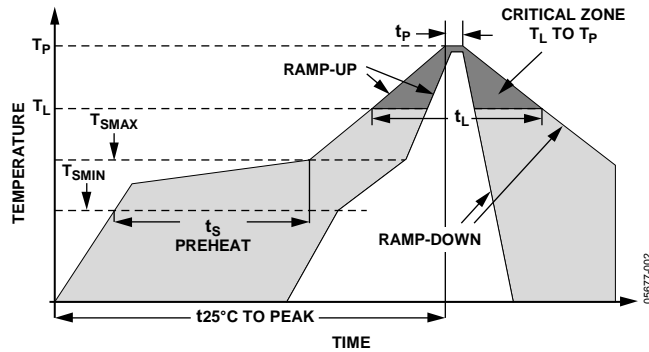

Figure 2. Recommended Soldering Profile

Table 3. Recommended Soldering Profile

Profile Feature	Sn63/Pb37	Pb-Free
Average Ramp Rate (T_L to T_P)	3°C/s max	3°C/s max
Preheat		
Minimum Temperature (T_{SMIN})	100°C	150°C
Maximum Temperature (T_{SMAX})	150°C	200°C
Time (T_{SMIN} to T_{SMAX}), t_s	60 s to 120 s	60 s to 180 s
T_{SMAX} to T_L		
Ramp-Up Rate	3°C/s max	3°C/s max
Time Maintained Above Liquidous (T_L)		
Liquidous Temperature (T_L)	183°C	217°C
Time (t_L)	60 s to 150 s	60 s to 150 s
Peak Temperature (T_P)	240°C + 0°C/-5°C	260°C + 0°C/-5°C
Time within 5°C of Actual Peak Temperature (t_p)	10 s to 30 s	20 s to 40 s
Ramp-Down Rate	6°C/s max	6°C/s max
Time 25°C to Peak Temperature	6 minutes max	8 minutes max

ESD CAUTION

ESD (electrostatic discharge) sensitive device. Electrostatic charges as high as 4000 V readily accumulate on the human body and test equipment and can discharge without detection. Although this product features proprietary ESD protection circuitry, permanent damage may occur on devices subjected to high energy electrostatic discharges. Therefore, proper ESD precautions are recommended to avoid performance degradation or loss of functionality.



PIN CONFIGURATION AND FUNCTION DESCRIPTIONS

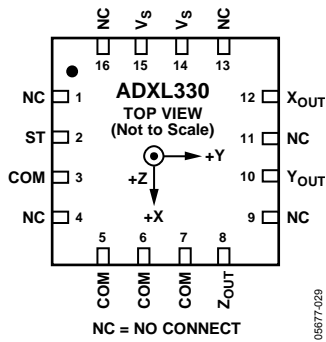

Figure 3. Pin Configuration

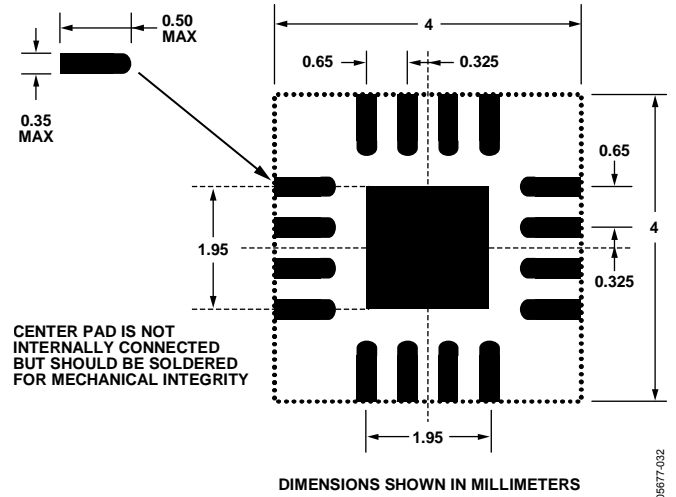

Figure 4. Recommended PCB Layout

Table 4. Pin Function Descriptions

Pin No.	Mnemonic	Description
1	NC	No Connect
2	ST	Self-Test
3	COM	Common
4	NC	No Connect
5	COM	Common
6	COM	Common
7	COM	Common
8	Z _{OUT}	Z Channel Output
9	NC	No Connect
10	Y _{OUT}	Y Channel Output
11	NC	No Connect
12	X _{OUT}	X Channel Output
13	NC	No Connect
14	V _s	Supply Voltage (2.0 V to 3.6 V)
15	V _s	Supply Voltage (2.0 V to 3.6 V)
16	NC	No Connect

ADXL330

TYPICAL PERFORMANCE CHARACTERISTICS

N > 1000 for all typical performance plots, unless otherwise noted.

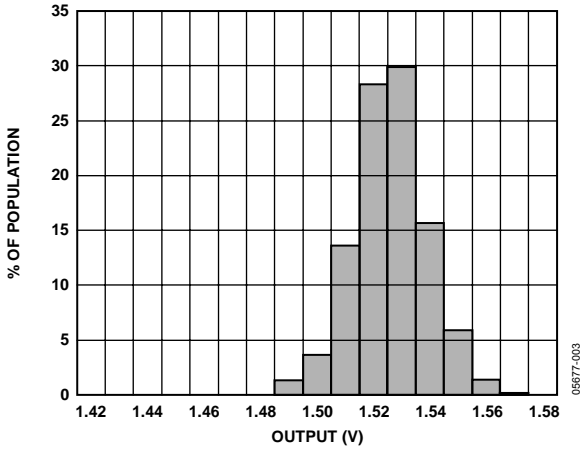

Figure 5. X-Axis Zero g Bias at 25°C, $V_S = 3 V$

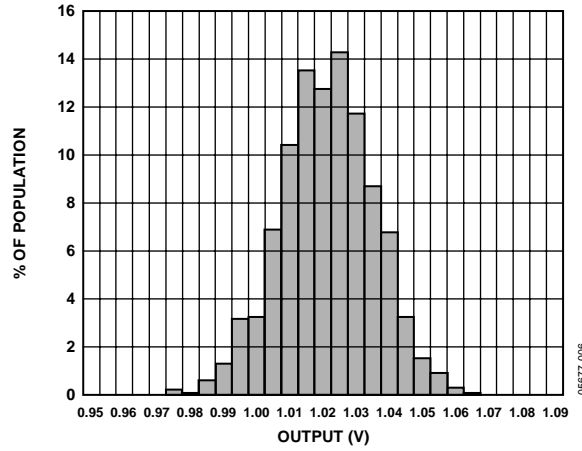

Figure 8. X-Axis Zero g Bias at 25°C, $V_S = 2 V$

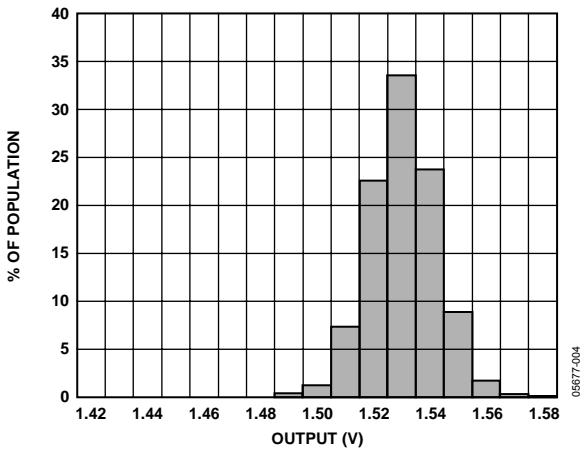

Figure 6. Y-Axis Zero g Bias at 25°C, $V_S = 3 V$

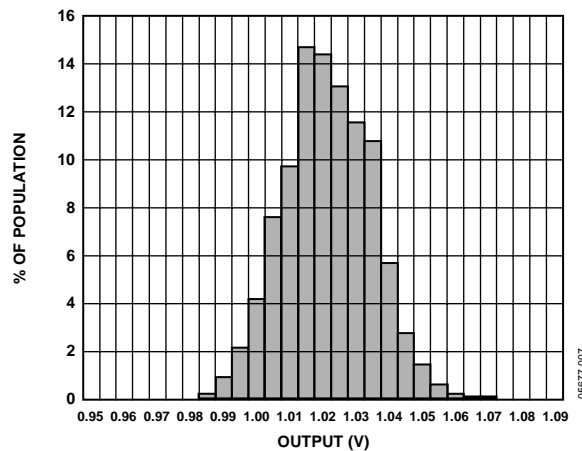

Figure 9. Y-Axis Zero g Bias at 25°C, $V_S = 2 V$

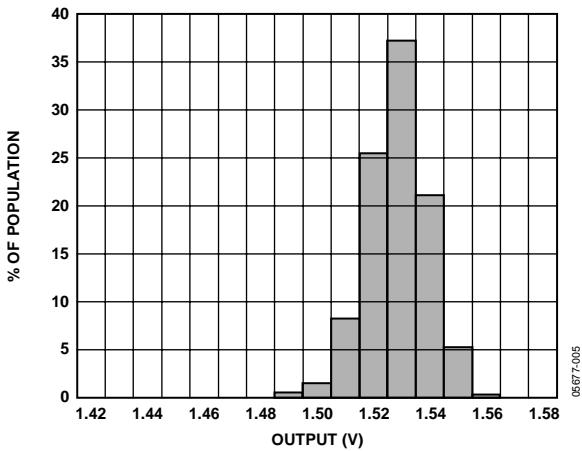

Figure 7. Z-Axis Zero g Bias at 25°C, $V_S = 3 V$

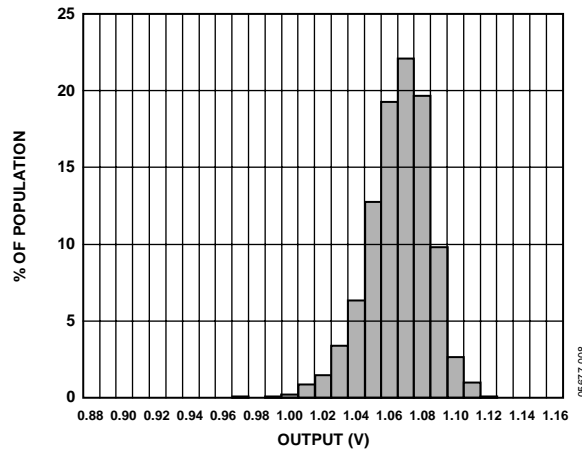

Figure 10. Z-Axis Zero g Bias at 25°C, $V_S = 2 V$

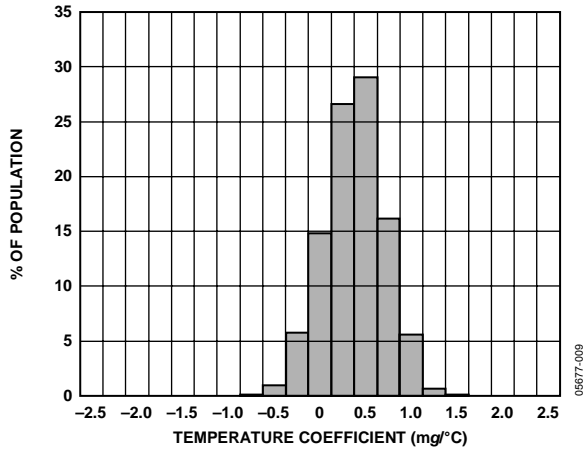

Figure 11. X-Axis Zero g Bias Temperature Coefficient, $V_s = 3\text{ V}$

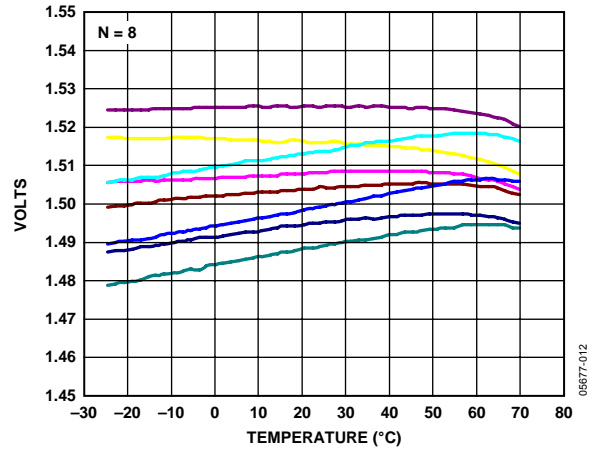

Figure 14. X-Axis Zero g Bias vs. Temperature—8 Parts Soldered to PCB

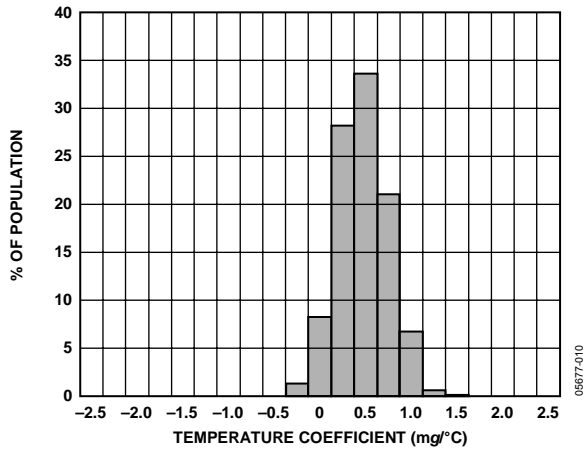

Figure 12. Y-Axis Zero g Bias Temperature Coefficient, $V_s = 3\text{ V}$

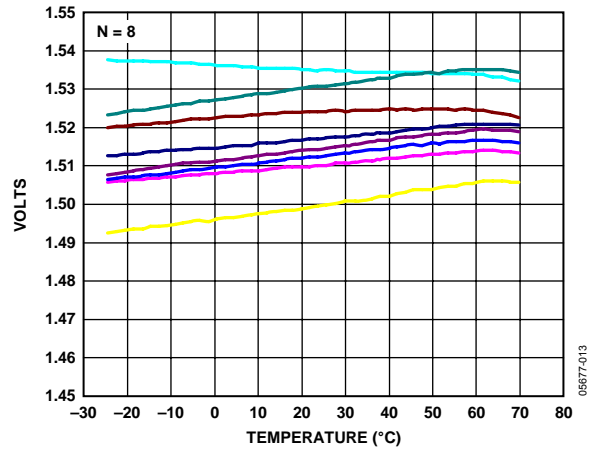

Figure 15. Y-Axis Zero g Bias vs. Temperature—8 Parts Soldered to PCB

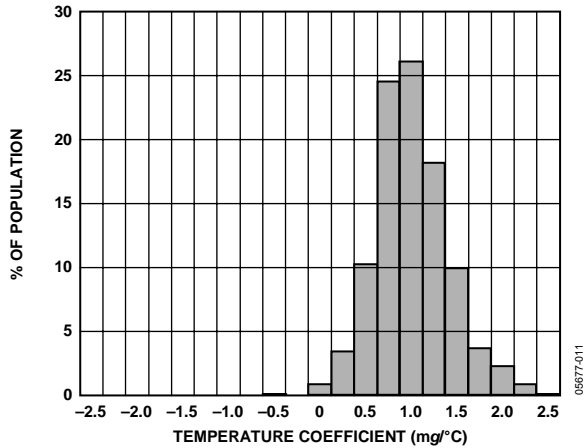

Figure 13. Z-Axis Zero g Bias Temperature Coefficient, $V_s = 3\text{ V}$

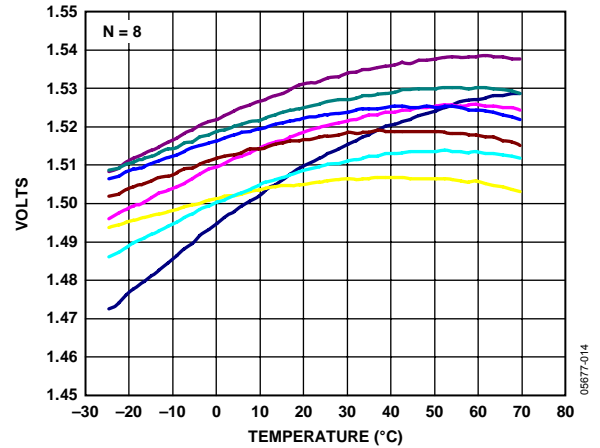

Figure 16. Z-Axis Zero g Bias vs. Temperature—8 Parts Soldered to PCB

ADXL330

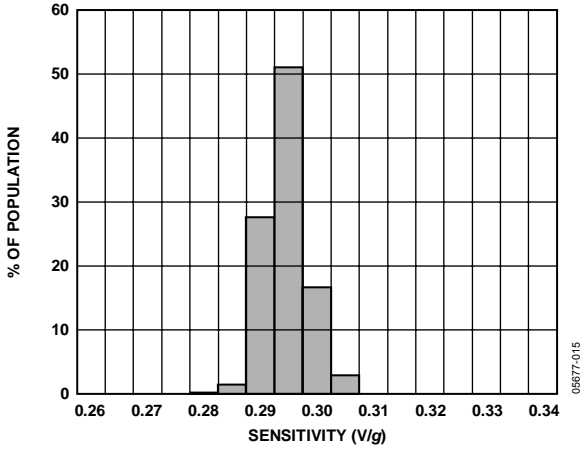

Figure 17. X-Axis Sensitivity at 25°C, $V_s = 3V$

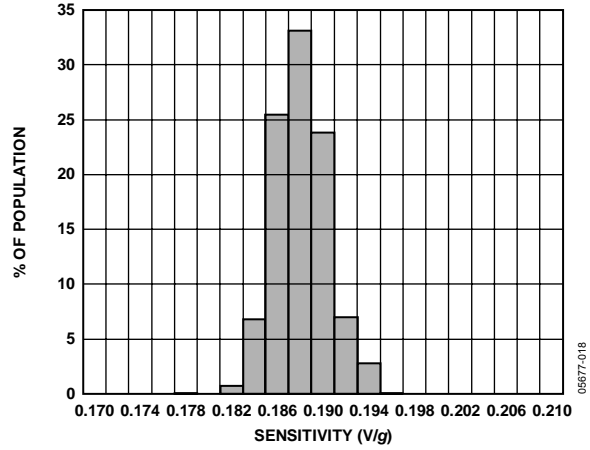

Figure 20. X-Axis Sensitivity at 25°C, $V_s = 2V$

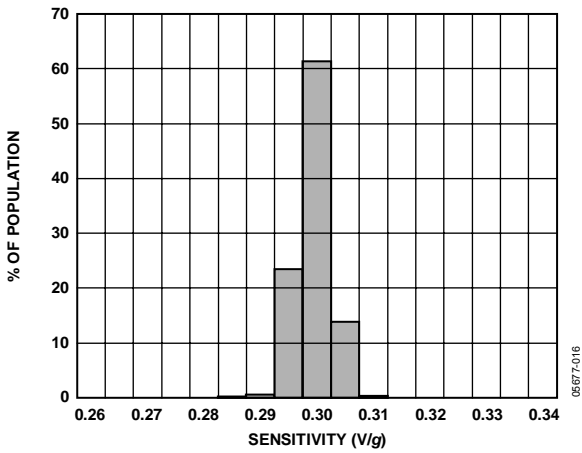

Figure 18. Y-Axis Sensitivity at 25°C, $V_s = 3V$

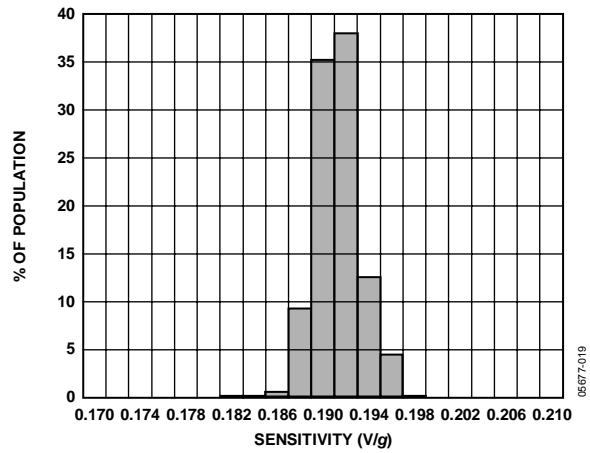

Figure 21. Y-Axis Sensitivity at 25°C, $V_s = 2V$

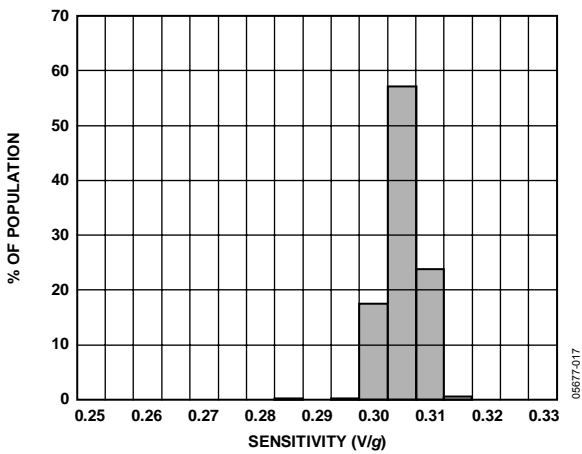

Figure 19. Z-Axis Sensitivity at 25°C, $V_s = 3V$

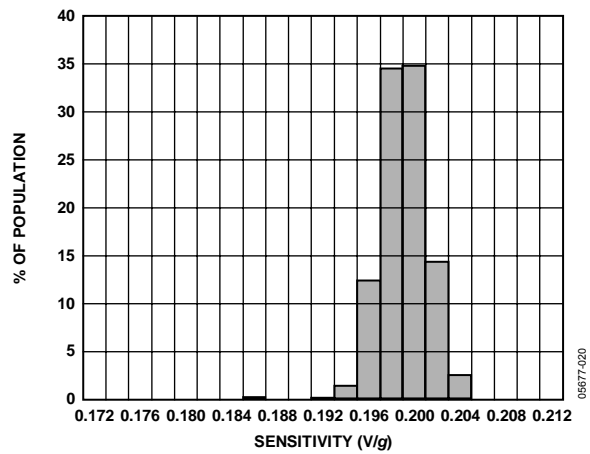

Figure 22. Z-Axis Sensitivity at 25°C, $V_s = 2V$

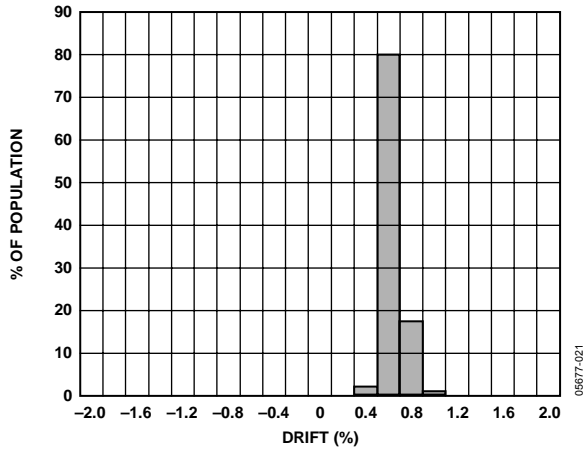

Figure 23. X-Axis Sensitivity Drift Over Temperature, $V_s = 3 V$

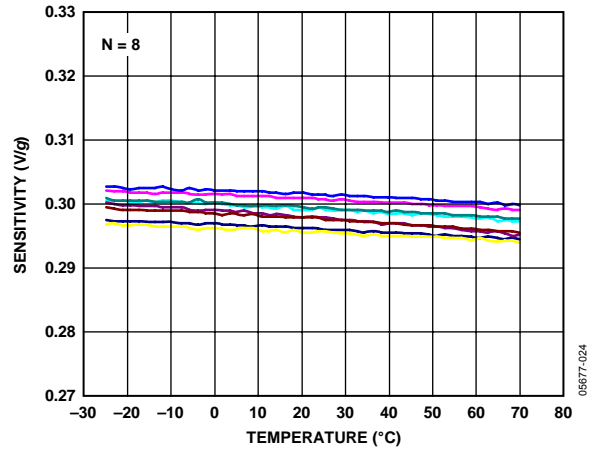

Figure 26. X-Axis Sensitivity vs. Temperature
8 Parts Soldered to PCB, $V_s = 3 V$

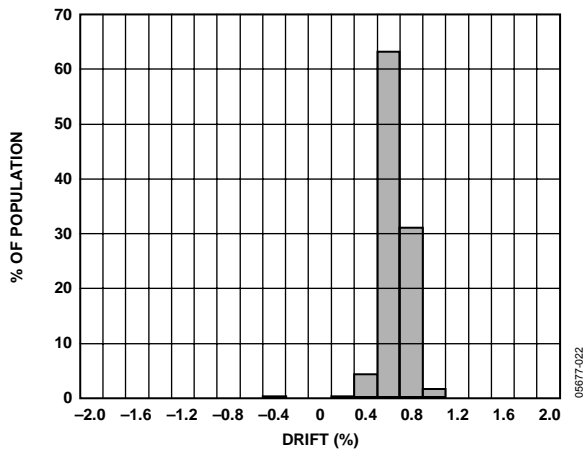

Figure 24. Y-Axis Sensitivity Drift Over Temperature, $V_s = 3 V$

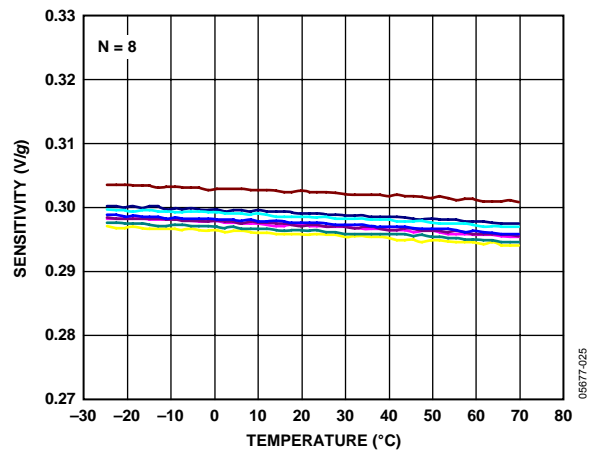

Figure 27. Y-Axis Sensitivity vs. Temperature
8 Parts Soldered to PCB, $V_s = 3 V$

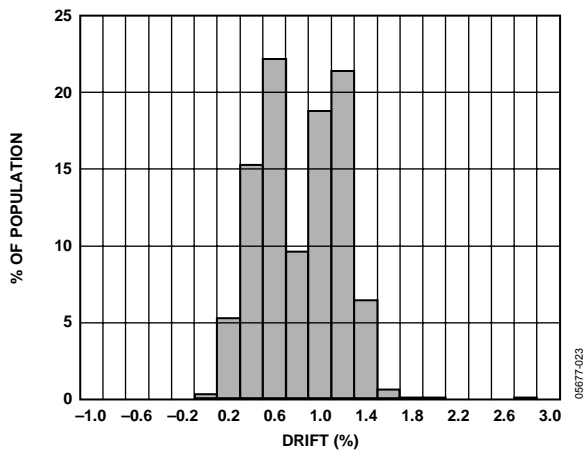

Figure 25. Z-Axis Sensitivity Drift Over Temperature, $V_s = 3 V$

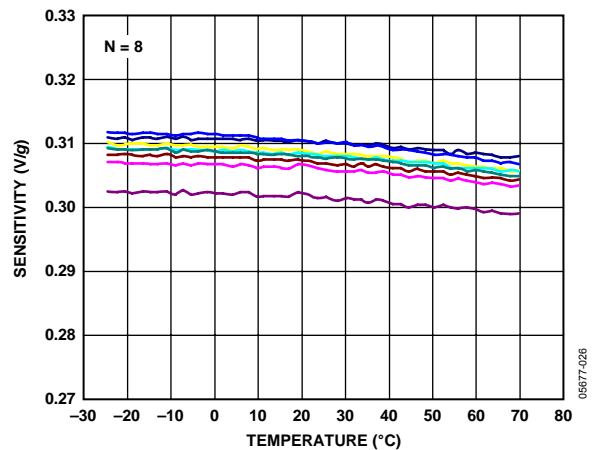

Figure 28. Z-Axis Sensitivity vs. Temperature
8 Parts Soldered to PCB, $V_s = 3 V$

ADXL330

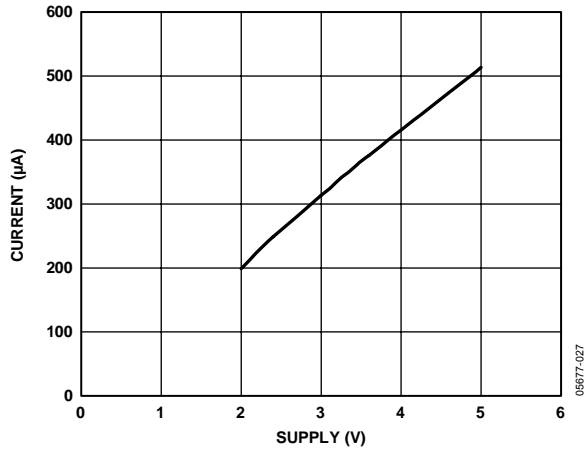

Figure 29. Typical Current Consumption vs. Supply Voltage

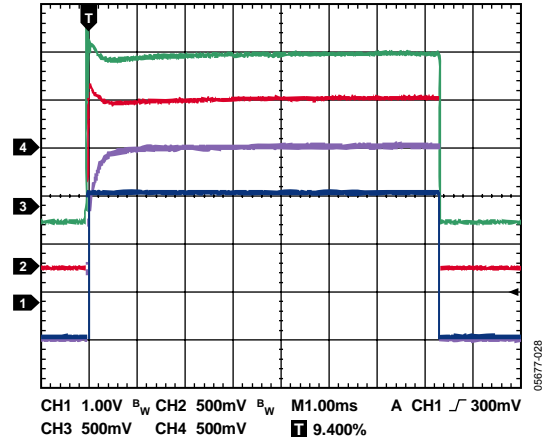

Figure 30. Typical Turn-On Time— $C_x, C_y, C_z = 0.0047 \mu F, V_s = 3 V$

THEORY OF OPERATION

The ADXL330 is a complete 3-axis acceleration measurement system on a single monolithic IC. The ADXL330 has a measurement range of $\pm 3g$ minimum. It contains a polysilicon surface micromachined sensor and signal conditioning circuitry to implement an open-loop acceleration measurement architecture. The output signals are analog voltages that are proportional to acceleration. The accelerometer can measure the static acceleration of gravity in tilt sensing applications as well as dynamic acceleration resulting from motion, shock, or vibration.

The sensor is a polysilicon surface micromachined structure built on top of a silicon wafer. Polysilicon springs suspend the structure over the surface of the wafer and provide a resistance against acceleration forces. Deflection of the structure is measured using a differential capacitor that consists of independent fixed plates and plates attached to the moving mass. The fixed plates are driven by 180° out-of-phase square waves. Acceleration deflects the moving mass and unbalances the differential capacitor resulting in a sensor output whose amplitude is proportional to acceleration. Phase-sensitive demodulation techniques are then used to determine the magnitude and direction of the acceleration.

The demodulator output is amplified and brought off-chip through a $32\text{ k}\Omega$ resistor. The user then sets the signal bandwidth of the device by adding a capacitor. This filtering improves measurement resolution and helps prevent aliasing.

MECHANICAL SENSOR

The ADXL330 uses a single structure for sensing the X, Y, and Z axes. As a result, the three axes sense directions are highly orthogonal with little cross axis sensitivity. Mechanical misalignment of the sensor die to the package is the chief source of cross axis sensitivity. Mechanical misalignment can, of course, be calibrated out at the system level.

PERFORMANCE

Rather than using additional temperature compensation circuitry, innovative design techniques ensure high performance is built-in to the ADXL330. As a result, there is neither quantization error nor nonmonotonic behavior, and temperature hysteresis is very low (typically less than 3 mg over the -25°C to $+70^\circ\text{C}$ temperature range).

Figure 14, Figure 15, and Figure 16 show the zero g output performance of eight parts (X-, Y-, and Z-axis) soldered to a PCB over a -25°C to $+70^\circ\text{C}$ temperature range.

Figure 26, Figure 27, and Figure 28 demonstrate the typical sensitivity shift over temperature for supply voltages of 3 V . This is typically better than $\pm 1\%$ over the -25°C to $+70^\circ\text{C}$ temperature range.

ADXL330

APPLICATIONS

POWER SUPPLY DECOUPLING

For most applications, a single 0.1 μF capacitor, C_{DC} , placed close to the ADXL330 supply pins adequately decouples the accelerometer from noise on the power supply. However, in applications where noise is present at the 50 kHz internal clock frequency (or any harmonic thereof), additional care in power supply bypassing is required as this noise can cause errors in acceleration measurement. If additional decoupling is needed, a 100 Ω (or smaller) resistor or ferrite bead can be inserted in the supply line. Additionally, a larger bulk bypass capacitor (1 μF or greater) can be added in parallel to C_{DC} . Ensure that the connection from the ADXL330 ground to the power supply ground is low impedance because noise transmitted through ground has a similar effect as noise transmitted through V_{S} .

SETTING THE BANDWIDTH USING C_X , C_Y , AND C_Z

The ADXL330 has provisions for band limiting the X_{OUT} , Y_{OUT} , and Z_{OUT} pins. Capacitors must be added at these pins to implement low-pass filtering for antialiasing and noise reduction. The equation for the 3 dB bandwidth is

$$F_{-3\text{dB}} = 1/(2\pi(32\text{ k}\Omega) \times C_{(X,Y,Z)})$$

or more simply

$$F_{-3\text{dB}} = 5\ \mu\text{F}/C_{(X,Y,Z)}$$

The tolerance of the internal resistor (R_{FILT}) typically varies as much as $\pm 15\%$ of its nominal value (32 k Ω), and the bandwidth varies accordingly. A minimum capacitance of 0.0047 μF for C_X , C_Y , and C_Z is recommended in all cases.

Table 5. Filter Capacitor Selection, C_X , C_Y , and C_Z

Bandwidth (Hz)	Capacitor (μF)
1	4.7
10	0.47
50	0.10
100	0.05
200	0.027
500	0.01

SELF-TEST

The ST pin controls the self-test feature. When this pin is set to V_{S} , an electrostatic force is exerted on the accelerometer beam. The resulting movement of the beam allows the user to test if the accelerometer is functional. The typical change in output is -500 mg (corresponding to -150 mV) in the X-axis, 500 mg (or 150 mV) on the Y-axis, and -200 mg (or -60 mV) on the Z-axis. This ST pin may be left open circuit or connected to common (COM) in normal use.

Never expose the ST pin to voltages greater than $V_{\text{S}} + 0.3\text{ V}$. If this cannot be guaranteed due to the system design (for

instance, if there are multiple supply voltages), then a low V_{F} clamping diode between ST and V_{S} is recommended.

DESIGN TRADE-OFFS FOR SELECTING FILTER CHARACTERISTICS: THE NOISE/BW TRADE-OFF

The selected accelerometer bandwidth ultimately determines the measurement resolution (smallest detectable acceleration). Filtering can be used to lower the noise floor to improve the resolution of the accelerometer. Resolution is dependent on the analog filter bandwidth at X_{OUT} , Y_{OUT} , and Z_{OUT} .

The output of the ADXL330 has a typical bandwidth of greater than 500 Hz. The user must filter the signal at this point to limit aliasing errors. The analog bandwidth must be no more than half the analog-to-digital sampling frequency to minimize aliasing. The analog bandwidth can be further decreased to reduce noise and improve resolution.

The ADXL330 noise has the characteristics of white Gaussian noise, which contributes equally at all frequencies and is described in terms of $\mu\text{g}/\sqrt{\text{Hz}}$ (the noise is proportional to the square root of the accelerometer bandwidth). The user should limit bandwidth to the lowest frequency needed by the application to maximize the resolution and dynamic range of the accelerometer.

With the single-pole, roll-off characteristic, the typical noise of the ADXL330 is determined by

$$\text{rms Noise} = \text{Noise Density} \times (\sqrt{BW} \times 1.6)$$

Often, the peak value of the noise is desired. Peak-to-peak noise can only be estimated by statistical methods. Table 6 is useful for estimating the probabilities of exceeding various peak values, given the rms value.

Table 6. Estimation of Peak-to-Peak Noise

Peak-to-Peak Value	% of Time that Noise Exceeds Nominal Peak-to-Peak Value
2 \times rms	32
4 \times rms	4.6
6 \times rms	0.27
8 \times rms	0.006

USE WITH OPERATING VOLTAGES OTHER THAN 3 V

The ADXL330 is tested and specified at $V_{\text{S}} = 3\text{ V}$; however, it can be powered with V_{S} as low as 2 V or as high as 3.6 V. Note that some performance parameters change as the supply voltage is varied.

The ADXL330 output is ratiometric, therefore, the output sensitivity (or scale factor) varies proportionally to the supply voltage. At $V_s = 3.6\text{ V}$, the output sensitivity is typically 360 mV/g . At $V_s = 2\text{ V}$, the output sensitivity is typically 195 mV/g .

The zero g bias output is also ratiometric, so the zero g output is nominally equal to $V_s/2$ at all supply voltages.

The output noise is not ratiometric but is absolute in volts; therefore, the noise density decreases as the supply voltage increases. This is because the scale factor (mV/g) increases while the noise voltage remains constant. At $V_s = 3.6\text{ V}$, the X- and Y-axis noise density is typically $230\text{ }\mu\text{g}/\sqrt{\text{Hz}}$, while at $V_s = 2\text{ V}$, the X- and Y-axis noise density is typically $350\text{ }\mu\text{g}/\sqrt{\text{Hz}}$.

Self-test response in g is roughly proportional to the square of the supply voltage. However, when ratiometricity of sensitivity is factored in with supply voltage, the self-test response in volts is roughly proportional to the cube of the supply voltage. For example, at $V_s = 3.6\text{ V}$, the self-test response for the ADXL330 is approximately -275 mV for the X-axis, $+275\text{ mV}$ for the Y-axis, and -100 mV for the Z-axis.

At $V_s = 2\text{ V}$, the self-test response is approximately -60 mV for the X-axis, $+60\text{ mV}$ for the Y-axis, and -25 mV for the Z-axis.

The supply current decreases as the supply voltage decreases. Typical current consumption at $V_s = 3.6\text{ V}$ is $375\text{ }\mu\text{A}$, and typical current consumption at $V_s = 2\text{ V}$ is $200\text{ }\mu\text{A}$.

AXES OF ACCELERATION SENSITIVITY

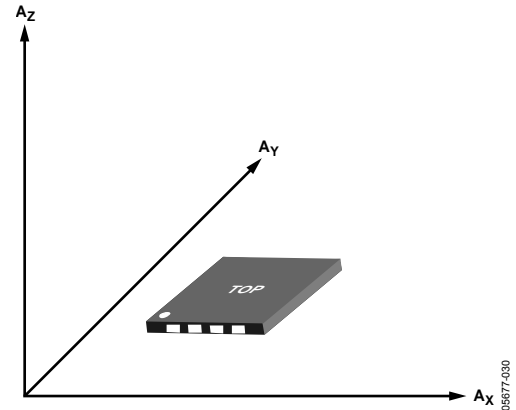

Figure 31. Axes of Acceleration Sensitivity, Corresponding Output Voltage Increases When Accelerated Along the Sensitive Axis

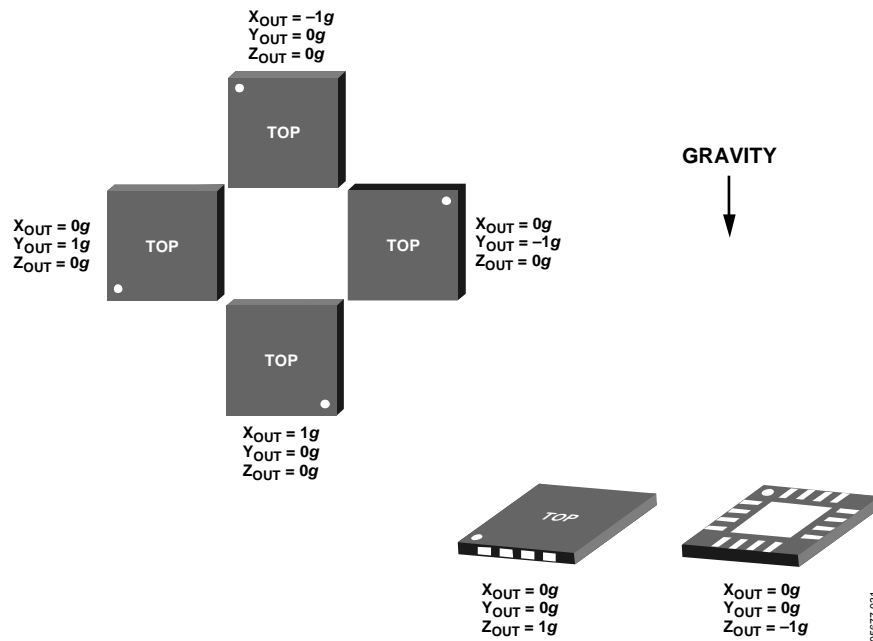

Figure 32. Output Response vs. Orientation to Gravity

ADXL330

OUTLINE DIMENSIONS

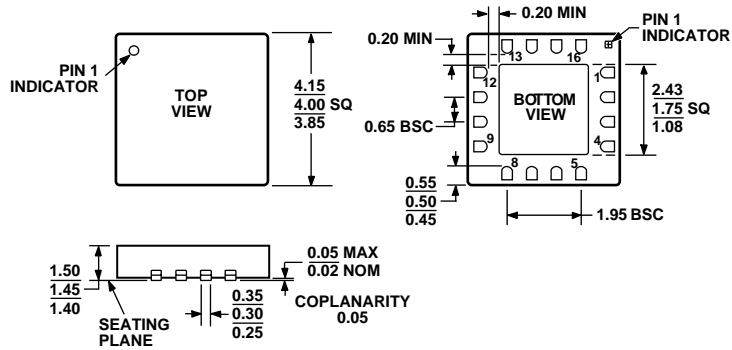

Figure 33. 16-Lead Lead Frame Chip Scale Package [LFCSP_LQ]
 4 mm × 4 mm Body, Thick Quad
 (CP-16-5)
 Dimensions shown in millimeters

ORDERING GUIDE

Model	Measurement Range	Specified Voltage	Temperature Range	Package Description	Package Option
ADXL330KCPZ ¹	±3 g	3 V	-25°C to +70°C	16-Lead LFCSP_LQ	CP-16-5
ADXL330KCPZ-RL ¹	±3 g	3 V	-25°C to +70°C	16-Lead LFCSP_LQ	CP-16-5
EVAL-ADXL330				Evaluation Board	

¹ Z = Pb-free part.

NOTES

ADXL330

NOTES

SUNSTAR商斯达实业集团是集研发、生产、工程、销售、代理经销、技术咨询、信息服务等为一体的高科技企业，是专业高科技电子产品生产厂家，是具有10多年历史的专业电子元器件供应商，是中国最早和最大的仓储式连锁规模经营大型综合电子零部件代理分销商之一，是一家专业代理和分销世界各大品牌IC芯片和电子元器件的连锁经营综合性国际公司。在香港、北京、深圳、上海、西安、成都等全国主要电子市场设有直属分公司和产品展示展销窗口门市部专卖店及代理分销商，已在全国范围内建成强大统一的供货和代理分销网络。我们专业代理经销、开发生产电子元器件、集成电路、传感器、微波光电元器件、工控机/DOC/DOM电子盘、专用电路、单片机开发、MCU/DSP/ARM/FPGA软件硬件、二极管、三极管、模块等，是您可靠的一站式现货配套供应商、方案提供商、部件功能模块开发配套商。专业以现代信息产业（计算机、通讯及传感器）三大支柱之一的传感器为主营业务，专业经营各类传感器的代理、销售生产、网络信息、科技图书资料及配套产品设计、工程开发。我们的专业网站——中国传感器科技信息网（全球传感器数据库）www.SENSOR-IC.COM 服务于全球高科技生产商及贸易商，为企业科技产品开发提供技术交流平台。欢迎各厂商互通有无、交换信息、交换链接、发布寻求代理信息。欢迎国外高科技传感器、变送器、执行器、自动控制产品厂商介绍产品到中国，共同开拓市场。本网站是关于各种传感器-变送器-仪器仪表及工业自动化大型专业网站，深入到工业控制、系统工程计 测量、自动化、安防报警、消费电子等众多领域，把最新的传感器-变送器-仪器仪表买卖信息，最新技术供求，最新采购商，行业动态，发展方向，最新的技术应用和市场资讯及时的传递给广大科技开发、科学研究、产品设计人员。本网站已成功为石油、化工、电力、医药、生物、航空、航天、国防、能源、冶金、电子、工业、农业、交通、汽车、矿山、煤炭、纺织、信息、通信、IT、安防、环保、印刷、科研、气象、仪器仪表等领域从事科学研究、产品设计、开发、生产制造的科技人员、管理人员、和采购人员提供满意服务。我们公司专业生产、代理、经销、销售各种传感器、变送器、敏感元器件、开关、执行器、仪器仪表、自动化控制系统：专业从事设计、生产、销售各种传感器、变送器、各种测控仪表、热工仪表、现场控制器、计算机控制系统、数据采集系统、各类环境监控系统、专用控制系统应用软件以及嵌入式系统开发及应用等工作。如热敏电阻、压敏电阻、温度传感器、温度变送器、湿度传感器、湿度变送器、气体传感器、气体变送器、压力传感器、压力变送、称重传感器、物（液）位传感器、物（液）位变送器、流量传感器、流量变送器、电流（压）传感器、溶氧传感器、霍尔传感器、图像传感器、超声波传感器、位移传感器、速度传感器、加速度传感器、扭距传感器、红外传感器、紫外传感器、火焰传感器、激光传感器、振动传感器、轴角传感器、光电传感器、接近传感器、干簧管传感器、继电器传感器、微型电泵、磁敏（阻）传感器、压力开关、接近开关、光电开关、色标传感器、光纤传感器、齿轮测速传感器、时间继电器、计数器、计米器、温控仪、固态继电器、调压模块、电磁铁、电压表、电流表等特殊传感器。同时承接传感器应用电路、产品设计和自动化工程项目。

更多产品请看本公司产品专用销售网站：

商斯达中国传感器科技信息网：<http://www.sensor-ic.com/>

商斯达工控安防网：<http://www.pc-ps.net/>

商斯达电子元器件网：<http://www.sunstare.com/>

商斯达微波光电产品网：[HTTP://www.rfoe.net/](http://www.rfoe.net/)

商斯达消费电子产品网：<http://www.icasic.com/>

商斯达军工产品网：<http://www.junpinic.com/>

商斯达实业科技产品网：<http://www.sunstars.cn/> 传感器销售热线：

地址：深圳市福田区福华路福庆街鸿图大厦1602室

电话：0755-83607652 83376489 83376549 83370250 83370251 82500323

传真：0755-83376182 (0) 13902971329 MSN: SUNS888@hotmail.com

邮编：518033 E-mail: szss20@163.com QQ: 195847376

深圳赛格展销部：深圳华强北路赛格电子市场2583号 电话：0755-83665529 25059422

技术支持：0755-83394033 13501568376

欢迎索取免费详细资料、设计指南和光盘；产品凡多，未能尽录，欢迎来电查询。

北京分公司：北京海淀区知春路132号中发电子大厦3097号

TEL: 010-81159046 82615020 13501189838 FAX: 010-62543996

上海分公司：上海市北京东路668号上海赛格电子市场D125号

TEL: 021-28311762 56703037 13701955389 FAX: 021-56703037

西安分公司：西安高新开发区20所(中国电子科技集团导航技术研究所)

西安劳动南路88号电子商城二楼D23号

TEL: 029-81022619 13072977981 FAX: 029-88789382