

PolySwitch Radial-leaded Resettable Devices

Raychem Circuit Protection has pioneered PPTC technology for over twenty years. Our radial-leaded products represent the widest range of product capabilities.

- RGE series for hold currents up to 14A
- RHE series for flatter thermal derating and operating temperatures up to 125°C
- RUE series for balance of voltage rating (30V) and hold current (up to 9A)
- RUSB series for fast time-to-trip and low-resistance computer applications
- RTE series specifically designed for IEEE-1394 applications
- RXE series for low hold currents (down to 50mA) and high voltage rating (up to 72V)
- TR600 series for North America telephone applications
- TR250 series for ITU telephone applications
- BBR series for cable telephone applications

Whether for design or volume application, our radial-leaded products represent the most comprehensive and complete set of PPTC products available in the industry today.

Benefits:

- Many product choices give engineers more design flexibility
- Compatible with high-volume electronics assembly
- Assists in meeting regulatory requirements
- Higher voltage ratings allow use in new applications

Devices in this section are grouped by:

Voltage Rating, Device Series, Hold Current

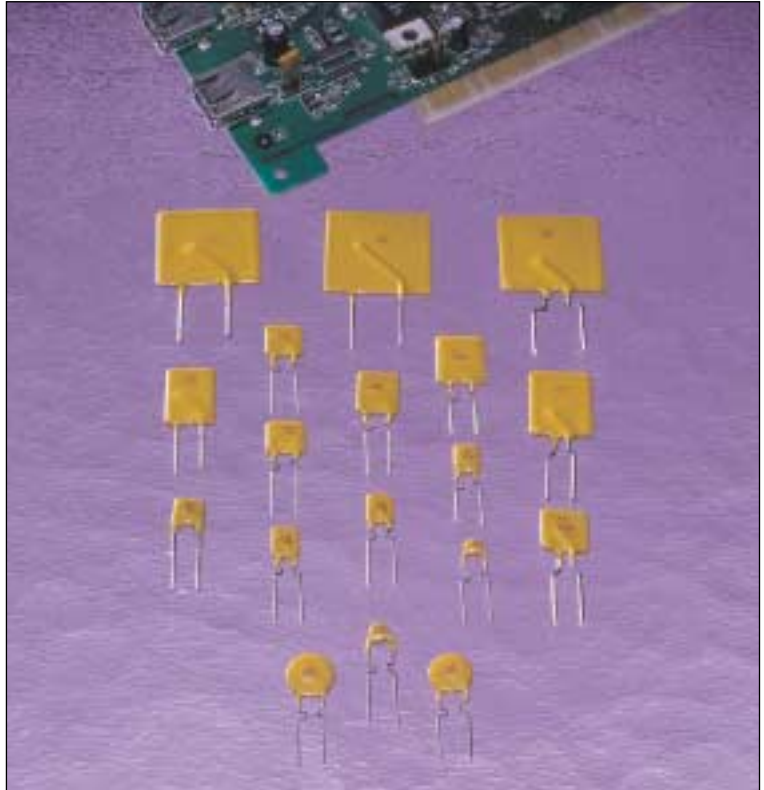

Features:

- Broadest range of radial-leaded resettable devices available in the industry
- Current ratings from 50mA to 14A
- Voltage ratings from 6V (computer and electronic applications) to 90V (cable and telecommunication equipment)
- Agency recognition: UL, CSA, TÜV
- Fast time-to-trip
- Low resistance

Applications:

- Satellite video receivers
- Industrial controls
- Transformers
- Computer motherboards
- Modems
- USB hub, ports and peripherals
- IEEE1394 ports
- CD-ROMs
- Game machines
- Battery packs
- Phones
- Fax machines
- Analog and digital line cards
- Printers

Selection Guide for Radial-leaded Devices

4

Step 1. Determine the circuit’s operating parameters.

Fill in the following information about the circuit:

Maximum ambient operating temperature _____

Normal operating current _____

Maximum operating voltage
(i.e., RUE135 is 30V max.) _____

Maximum interrupt current _____

Step 2. Select the PolySwitch device that will accommodate the circuit’s maximum ambient temperature and normal operating current.

Look across the top of Table R2 to find the temperature that most closely matches the circuit’s maximum operating temperature. Look down that column to find the value equal to or greater than the circuit’s normal operating current. Now look to the far left of that row to find the part number for the PolySwitch device that will best accommodate the circuit. Devices in this section are grouped by voltage rating; therefore, your operating current requirement may be found in more than one product grouping.

The thermal derating curves located in Figures R1–R4 are the normalized representations of the data in Table R2.

Step 3. Compare the maximum electrical ratings of the selected device with the maximum operating voltage and maximum interrupt currents of the circuit.

Look down the first column of Table R3 to find the part number you selected in Step 2. Look to the right in that row to find the device’s maximum operating voltage (V_{MAX}) and maximum interrupt current (I_{MAX}). Ensure that V_{MAX} and I_{MAX} are greater than or equal to operating voltage and maximum interrupt current.

Step 4. Determine time-to-trip.

Time-to-trip is the amount of time it takes for a device to switch to a high-resistance state once a fault current has been applied across the device. Identifying the PolySwitch device's time-to-trip is important in order to provide the desired protection capabilities. If the device you choose trips too fast, undesired or nuisance tripping will occur. If the device trips too slowly, the components being protected may be damaged before the device switches to a high-resistance state.

Refer to the typical time-to-trip curves for each of the PolySwitch devices found in Figures R16–R21.

If the time-to-trip of the PolySwitch device is too fast or too slow for the circuit, go back to Step 2 and choose an alternate device.

Step 5. Verify ambient operating conditions.

Ensure that your application's minimum and maximum ambient temperatures are within the operating temperature of -40°C to 85°C (-40 to 125°C for RHE device series).

Step 6. Verify the PolySwitch device dimensions.

Using the dimensions in Table R4, compare the dimensions of the PolySwitch device you selected with the application's space considerations.

Protection Application Selection Guide for Radial-leaded Devices

The guide below lists PolySwitch devices that are typically used in these applications.

Specifications for the suggested device part numbers can be found in this section.

Once a part number has been selected, the user should evaluate and test each product for its intended application.

Protection Application	PolySwitch Resettable Devices—Key Selection Criteria		
	Small Size	Flatter Derating	Lower Current Higher Voltage
Electromagnetic loads	RGE (<16V), RUE (<30V)	RHE (<16V)	RXE
Halogen lighting	RGE (<16V), RUE (<30V)	RHE (<16V)	RXE
Lighting ballast	RXE, BBR		
Loudspeakers	RXE		
Medical equipment	RGE (<16V), RUE (<30V)	RHE (<16V)	RXE
MOSFET devices	RGE (<16V), RUE (<30V)	RHE (<16V)	RXE
Motors, fans, and blowers	RXE (<72V), RGE (<16V)	RHE (<16V)	
POS equipment	RXE, RUE		
Process and industrial controls	RXE, RUE		
Satellite video receivers	RGE (<16V), RUE (<30V)	RHE (<16V)	RXE
Security and fire alarm systems	RGE (<16V), RUE (<30V)	RHE (<16V)	RXE
Test and measurement equipment	RGE (<16V), RUE (<30V)	RHE (<16V)	RXE
Transformers	RGE (<16V), RUE (<30V)	RHE (<16V)	RXE
UL1950/FCC Part 68 requirements	RXE		
DDC computer video ports	RUE		
IEEE-1394 computer and consumer electronics	RTE		
Mouse and keyboard	RUE		
SCSI	RUE		
USB	RUSB		
Traces and printed circuit board protection	RGE (<16V), RUE (<30V)	RHE (<16V)	RXE

This list is not exhaustive. Raychem Circuit Protection welcomes customer's input for additional application ideas for PolySwitch resettable devices.

Table R1. Product Series – Current Rating, Voltage Rating/Typical Resistance for Radial-leaded Devices

Voltage Rating	BBR 99V	TR600 60/600V*	TR250 60/250V*	RXE 72V	RXE 60V	RTE 33V	RUE 30V	RGE 16V	RHE 16V	RUSB 16V	RUSB 6V
Hold Current (A)	—	—	—	—	9.2Ω	—	—	—	—	—	—
0.050	—	—	—	—	10.0Ω	—	—	—	—	—	—
0.080	—	—	17.0Ω	—	—	—	—	—	—	—	—
0.100	—	—	—	—	3.50Ω	—	—	—	—	—	—
0.110	—	—	—	—	—	—	—	—	—	—	—
0.120	—	—	6.0Ω	—	—	—	—	—	—	—	—
0.145	—	—	4.5Ω	—	—	—	—	—	—	—	—
0.150	—	9.0Ω	—	—	—	—	—	—	—	—	—
0.160	—	7.0Ω	—	—	—	—	—	—	—	—	—
0.170	—	—	—	—	4.30Ω	—	—	—	—	—	—
0.180	—	—	1.4Ω	—	—	—	—	—	—	—	—
0.200	—	—	—	2.29Ω	—	—	—	—	—	—	—
0.250	—	—	—	1.60Ω	—	—	—	—	—	—	—
0.300	—	—	—	1.11Ω	—	—	—	—	—	—	—
0.400	—	—	—	0.71Ω	—	—	—	—	—	—	—
0.500	—	—	—	0.64Ω	—	—	—	—	—	—	—
0.550	1.05Ω	—	—	—	—	—	—	—	—	—	—
0.650	—	—	—	0.40Ω	—	—	—	—	—	—	—
0.700	—	—	—	—	—	—	—	—	0.42Ω	—	—
0.750	0.58Ω	—	—	0.325Ω	—	—	—	—	—	—	0.14Ω
0.900	—	—	—	0.255Ω	—	—	0.095Ω	—	—	0.10Ω	—
1.10	—	—	—	0.200Ω	—	—	0.075Ω	—	—	0.075Ω	—
1.20	—	—	—	—	—	0.097Ω	—	—	—	—	0.080Ω
1.35	—	—	—	0.155Ω	—	0.080Ω	0.060Ω	—	—	0.060Ω	—
1.55	—	—	—	—	—	—	—	—	—	—	0.058Ω
1.60	—	—	—	0.115Ω	—	—	0.050Ω	—	—	0.050Ω	—
1.85	—	—	—	0.100Ω	—	—	0.045Ω	—	—	0.045Ω	—
1.90	—	—	—	—	—	0.054Ω	—	—	—	—	—
2.50	—	—	—	0.065Ω	—	—	0.030Ω	—	—	0.030Ω	—
3.00	—	—	—	0.050Ω	—	—	0.035Ω	0.0514Ω	—	—	—
3.75	—	—	—	0.040Ω	—	—	—	—	—	—	—
4.00	—	—	—	—	—	—	0.020Ω	0.030Ω	0.029Ω	—	—
4.50	—	—	—	—	—	—	—	—	0.029Ω	—	—
5.00	—	—	—	—	—	—	0.020Ω	0.0192Ω	—	—	—
6.00	—	—	—	—	—	—	0.013Ω	0.0145Ω	0.0175Ω	—	—
6.50	—	—	—	—	—	—	—	—	0.0144Ω	—	—
7.00	—	—	—	—	—	—	0.013Ω	0.0105Ω	—	—	—
7.50	—	—	—	—	—	—	—	—	0.0173Ω	—	—
8.00	—	—	—	—	—	—	0.013Ω	0.0086Ω	—	—	—
9.00	—	—	—	—	—	—	0.008Ω	0.0070Ω	—	—	—
10.0	—	—	—	—	—	—	—	0.0056Ω	0.0083Ω	—	—
11.0	—	—	—	—	—	—	—	0.0050Ω	—	—	—
12.0	—	—	—	—	—	—	—	0.0046Ω	—	—	—
13.0	—	—	—	—	—	—	—	—	0.0055Ω	—	—
14.0	—	—	—	—	—	—	—	0.0040Ω	—	—	—
15.0	—	—	—	—	—	—	—	—	0.0092Ω	—	—

*Refer to Telecommunications and Networking section for specific voltage rating information.

Table R2. Thermal Derating for Radial-leaded Devices [Hold Current (A) at Ambient Temperature (°C)]

Part Number	Maximum Ambient Temperature											
	-40°C	-20°C	0°C	20°C	25°C	40°C	50°C	60°C	70°C	85°C	125°C	
BBR												
90V												
BBR550	0.85	0.75	0.65	0.55	—	0.45	0.40	0.35	0.3	0.22	—	
BBR750	1.15	1.00	0.90	0.75	—	0.61	0.55	0.48	0.41	0.30	—	
TR250, TR600												
60/600V For a complete selection of the TR series see the Telecommunications and Network section.												
TR250-080U	0.124	0.110	0.095	0.080	0.077	0.066	0.059	0.051	0.044	0.033	—	
TR250-120	0.186	0.165	0.143	0.120	0.115	0.099	0.088	0.077	0.066	0.050	—	
TR250-145	0.225	0.199	0.172	0.145	0.139	0.119	0.106	0.093	0.080	0.060	—	
TR250-180U	0.269	0.240	0.211	0.180	0.173	0.153	0.138	0.123	0.109	0.087	—	
TR600-150	0.233	0.206	0.178	0.150	0.143	0.124	0.110	0.096	0.083	0.062	—	
TR600-160	0.249	0.219	0.190	0.160	0.153	0.132	0.117	0.103	0.088	0.066	—	
RXE												
60V												
RXE005	0.078	0.068	0.06	0.05	0.048	0.04	0.035	0.032	0.027	0.02	—	
RXE010	0.16	0.14	0.11	0.10	0.096	0.08	0.072	0.067	0.05	0.04	—	
RXE017	0.26	0.23	0.21	0.17	0.16	0.14	0.12	0.11	0.09	0.07	—	
RXE												
72V												
RXE020	0.31	0.27	0.24	0.20	0.19	0.16	0.14	0.13	0.11	0.08	—	
RXE025	0.39	0.34	0.30	0.25	0.24	0.20	0.18	0.16	0.14	0.10	—	
RXE030	0.47	0.41	0.36	0.30	0.29	0.24	0.22	0.20	0.16	0.12	—	
RXE040	0.62	0.54	0.48	0.40	0.38	0.32	0.29	0.25	0.22	0.16	—	
RXE050	0.78	0.68	0.60	0.50	0.48	0.41	0.36	0.32	0.27	0.20	—	
RXE065	1.01	0.88	0.77	0.65	0.62	0.53	0.47	0.41	0.35	0.26	—	
RXE075	1.16	1.02	0.89	0.75	0.72	0.61	0.54	0.47	0.41	0.30	—	
RXE090	1.40	1.22	1.07	0.90	0.86	0.73	0.65	0.57	0.49	0.36	—	
RXE110	1.71	1.50	1.31	1.10	1.06	0.89	0.79	0.69	0.59	0.44	—	
RXE135	2.09	1.84	1.61	1.35	1.30	1.09	0.97	0.85	0.73	0.54	—	
RXE160	2.48	2.18	1.90	1.60	1.54	1.30	1.15	1.01	0.86	0.64	—	
RXE185	2.87	2.52	2.20	1.85	1.78	1.50	1.33	1.17	1.00	0.74	—	
RXE250	3.88	3.40	2.98	2.50	2.40	2.03	1.80	1.58	1.35	1.00	—	
RXE300	4.65	4.08	3.57	3.00	2.88	2.43	2.16	1.89	1.62	1.20	—	
RXE375	5.81	5.10	4.46	3.75	3.60	3.04	2.70	2.36	2.03	1.50	—	
RTE												
33V												
RTE120	1.74	1.56	1.38	1.20	1.16	1.00	0.92	0.82	0.73	0.60	—	
RTE135	1.96	1.76	1.55	1.35	1.31	1.12	1.04	0.92	0.82	0.68	—	
RTE190	2.76	2.47	2.19	1.90	1.84	1.58	1.50	1.29	1.16	0.95	—	

**Table R2. Thermal Derating for Radial-led Devices [Hold Current (A) at Ambient Temperature (°C)]
continued**

Part Number	Maximum Ambient Temperature										
	-40°C	-20°C	0°C	20°C	25°C	40°C	50°C	60°C	70°C	85°C	125°C
RUE											
30V											
RUE090	1.31	1.17	1.04	0.90	0.87	0.75	0.69	0.61	0.55	0.47	—
RUE110	1.60	1.43	1.27	1.10	1.07	0.91	0.85	0.75	0.67	0.57	—
RUE135	1.96	1.76	1.55	1.35	1.31	1.12	1.04	0.92	0.82	0.70	—
RUE160	2.32	2.08	1.84	1.60	1.55	1.33	1.23	1.09	0.98	0.83	—
RUE185	2.68	2.41	2.13	1.85	1.79	1.54	1.42	1.26	1.13	0.96	—
RUE250	3.63	3.25	2.88	2.5	2.43	2.08	1.93	1.70	1.53	1.30	—
RUE300	4.35	3.90	3.45	3.0	2.91	2.49	2.31	2.04	1.83	1.56	—
RUE400	5.80	5.20	4.60	4.0	3.88	3.32	3.08	2.72	2.44	2.08	—
RUE500	7.25	6.50	5.75	5.0	4.85	4.15	3.85	3.40	3.05	2.60	—
RUE600	8.70	7.80	6.90	6.0	5.82	4.98	4.62	4.08	3.66	3.12	—
RUE700	10.15	9.10	8.05	7.0	6.79	5.81	5.39	4.76	4.27	3.64	—
RUE800	11.60	10.40	9.20	8.0	7.76	6.64	6.16	5.44	4.88	4.16	—
RUE900	13.05	11.70	10.35	9.0	8.73	7.47	6.93	6.12	5.49	4.68	—
RUSB											
16V											
RUSB090	1.31	1.17	1.04	0.90	0.87	0.75	0.69	0.61	0.55	0.47	—
RUSB110	1.60	1.43	1.27	1.10	1.07	1.00	0.92	0.75	0.67	0.57	—
RUSB135	1.96	1.76	1.55	1.35	1.31	1.12	1.04	0.92	0.82	0.70	—
RUSB160	2.32	2.08	1.84	1.60	1.55	1.33	1.23	1.09	0.98	0.83	—
RUSB185	2.68	2.41	2.13	1.85	1.79	1.54	1.42	1.26	1.13	0.96	—
RUSB250	3.63	3.25	2.88	2.50	2.43	2.08	1.93	1.70	1.53	1.30	—
RGE											
16V											
RGE250	3.7	3.3	3.0	2.6	2.5	2.2	2.0	1.3	1.6	1.2	—
RGE300	4.4	4.0	3.6	3.1	3.0	2.6	2.4	2.1	1.9	1.4	—
RGE400	5.9	5.3	4.8	4.1	4.0	3.5	3.2	2.8	2.5	1.9	—
RGE500	7.3	6.6	6.0	5.2	5.0	4.4	4.0	3.6	3.1	2.4	—
RGE600	8.8	8.0	7.2	6.2	6.0	5.2	4.8	4.2	3.8	2.8	—
RGE700	10.3	9.3	8.4	7.3	7.0	6.2	5.6	5.0	4.4	3.3	—
RGE800	11.7	10.7	9.6	8.3	8.0	6.9	6.4	5.6	5.1	3.7	—
RGE900	13.2	11.9	10.7	9.4	9.0	7.9	7.2	6.4	5.6	4.2	—
RGE1000	14.7	13.3	12.0	10.3	10.0	8.7	8.0	7.0	6.3	4.7	—
RGE1100	16.1	14.6	13.1	11.5	11.0	9.7	8.8	7.8	6.9	5.2	—
RGE1200	17.6	16.0	14.4	12.4	12.0	10.4	9.6	8.4	7.6	5.6	—
RGE1400	20.5	18.7	16.8	14.5	14.0	12.1	11.2	9.8	8.9	6.5	—
RHE											
16V - High Temperature											
RHE070	0.95	0.87	0.79	0.72	0.70	0.62	0.56	0.51	0.47	0.39	0.17
RHE400	5.4	5.0	4.6	4.1	4.0	3.5	3.2	3.0	2.6	2.2	0.98
RHE450	6.1	5.6	5.1	4.6	4.5	4.0	3.6	3.3	3.0	2.5	1.1
RHE600	8.2	7.5	6.8	6.2	6.0	5.3	4.9	4.4	4.0	3.3	1.5
RHE650	8.8	8.1	7.4	6.7	6.5	5.7	5.3	4.8	4.3	3.6	1.6
RHE750	10.2	9.4	8.6	7.7	7.5	6.6	6.1	5.6	5.0	4.1	1.9
RHE1000	13.6	12.5	11.4	10.3	10.0	8.8	8.1	7.4	6.6	5.5	2.5
RHE1300	17.7	16.3	14.8	13.4	13.0	11.4	10.5	9.6	8.6	7.2	3.3
RHE1500	20.4	18.8	17.1	15.5	15.0	13.2	12.1	11.1	9.9	8.3	3.8

Table R2. Thermal Derating for Radial-led Devices [Hold Current (A) at Ambient Temperature (°C)]
continued

Part Number	Maximum Ambient Temperature										
	-40°C	-20°C	0°C	20°C	25°C	40°C	50°C	60°C	70°C	85°C	125°C
RUSB 6V											
RUSB075	1.05	0.95	0.85	0.75	0.73	0.65	0.60	0.55	0.50	0.43	—
RUSB120	1.69	1.52	1.36	1.20	1.16	1.04	0.96	0.88	0.80	0.68	—
RUSB155	2.17	1.96	1.75	1.55	1.50	1.34	1.24	1.14	1.03	0.88	—

Figures R1–R4. Thermal Derating Curves for Radial-led Devices

RXE and BBR

4

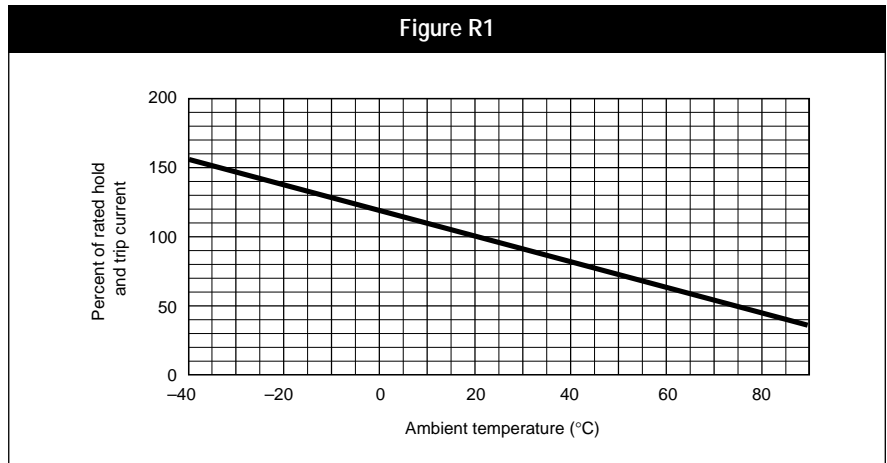

A = RUSB075,
RUSB120, and
RUSB155 devices

B = RUE, RTE,
and all other
RUSB devices

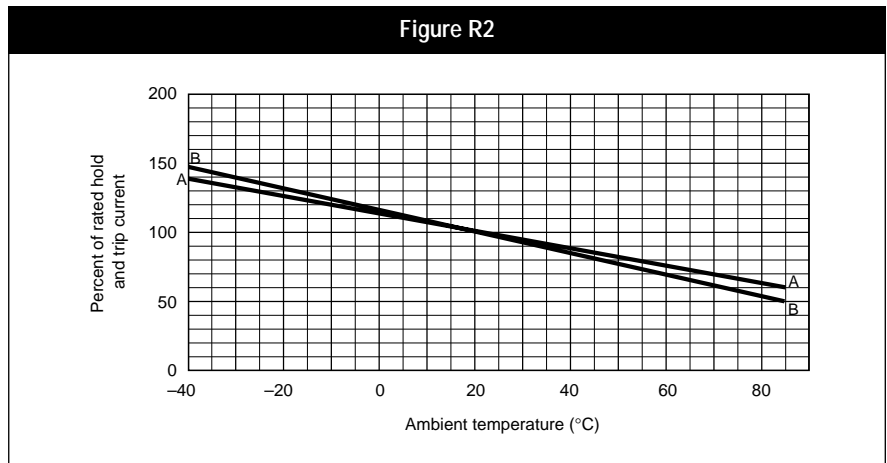

Figures R1–R4. Thermal Derating Curve for Radial-led Devices *continued*

RHE

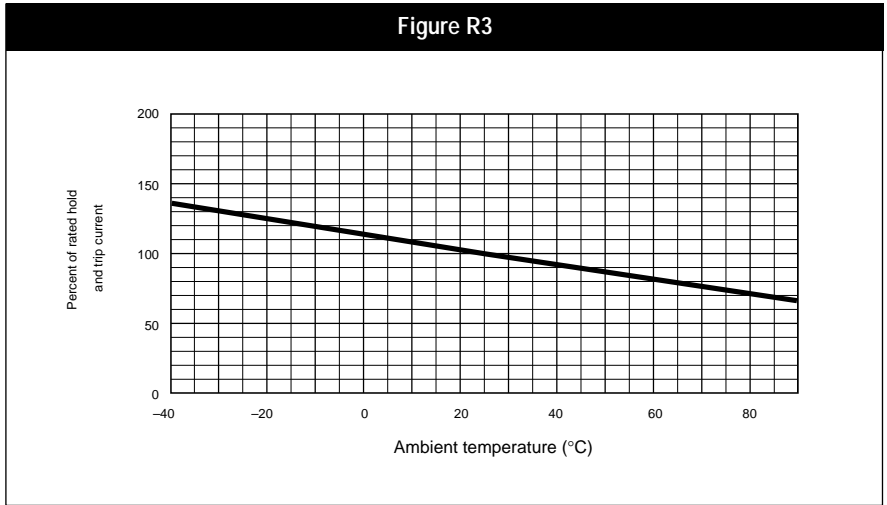

RGE

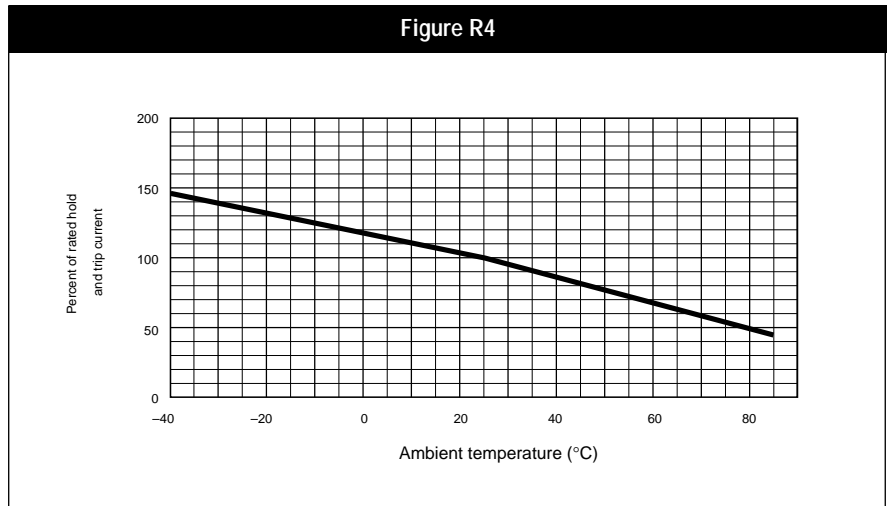

4

Table R3. Electrical Characteristics for Radial-led Devices

Part Number	I _H (A)	I _T (A)	V _{MAX} (V)	I _{MAX} (A)	P _D TYP (W)	Max. Time-to-trip		R _{MIN} (Ω)	R _{MAX} (Ω)	R ₁ MAX (Ω)	Figures for Dimensions	Lead Size [mm ² (AWG)]
						(A)	(s)					

**BBR
90V**

New BBR550	0.55	1.4	99	20	1.5	1.6	60	0.8	1.3	1.95	R5, R14, R15	[0.52mm ² (20)]
New BBR750	0.75	1.5	99	20	1.7	2.0	60	0.40	0.75	1.2	R5, R14, R15	[0.52mm ² (20)]

TR250, TR600

60/600V Product For a complete selection of the TR devices, see the Telecommunications and Networking section.

TR250-080U	0.080	0.160	250	3.0	1.0	0.35	3.0	14.0	20.0	33.0	R6	[0.33mm ² (22)]
TR250-120	0.120	0.240	250	3.0	1.0	1.0	1.5*	4.0	8.0	16.0	R7	[0.33mm ² (22)]
TR250-145	0.145	0.290	250	3.0	1.0	1.0	2.5*	3.0	6.0	14.0	R7	[0.33mm ² (22)]
TR250-180U	0.180	0.360	250	10.0	1.0	1.0	12.0*	0.8	2.0	4.0	R7	[0.33mm ² (22)]
TR600-150	0.150	0.300	600	3.0	1.0	1.0	5.0*	6.0	12.0	22.0	R7	[0.33mm ² (22)]
TR600-160	0.160	0.320	600	3.0	1.0	1.0	7.0*	4.0	10.0	18.0	R7	[0.33mm ² (22)]

*Time-to-trip value is typical.

**RXE
60V**

New RXE005	0.05	0.10	60	40	0.26	0.25	5.0	7.3	11.10	20.0	R8, R14, R15	[0.128mm ² (26)]
RXE010	0.10	0.20	60	40	0.38	0.50	4.0	2.5	4.50	7.5	R9, R14, R15	[0.205mm ² (24)]
RXE017	0.17	0.34	60	40	0.48	0.85	3.0	3.3	5.21	8.0	R9, R14, R15	[0.205mm ² (24)]

**RXE
72V**

RXE020	0.20	0.40	72	40	0.41	1.00	2.2	1.83	2.75	4.40	R9, R14, R15	[0.205mm ² (24)]
RXE025	0.25	0.50	72	40	0.45	1.25	2.5	1.25	1.95	3.00	R9, R14, R15	[0.205mm ² (24)]
RXE030	0.30	0.60	72	40	0.49	1.50	3.0	0.88	1.33	2.10	R9, R14, R15	[0.205mm ² (24)]
RXE040	0.40	0.80	72	40	0.56	2.00	3.8	0.55	0.86	1.29	R9, R14, R15	[0.205mm ² (24)]
RXE050	0.50	1.00	72	40	0.77	2.50	4.0	0.50	0.77	1.17	R9, R14, R15	[0.205mm ² (24)]
RXE065	0.65	1.30	72	40	0.88	3.25	5.3	0.31	0.48	0.72	R9, R14, R15	[0.205mm ² (24)]
RXE075	0.75	1.50	72	40	0.92	3.75	6.3	0.25	0.40	0.60	R9, R14, R15	[0.205mm ² (24)]
RXE090	0.90	1.80	72	40	0.99	4.50	7.2	0.20	0.31	0.47	R9, R14, R15	[0.205mm ² (24)]
RXE110	1.10	2.20	72	40	1.50	5.50	8.2	0.15	0.25	0.38	R10, R14, R15	[0.52mm ² (20)]
RXE135	1.35	2.70	72	40	1.70	6.75	9.6	0.12	0.19	0.30	R10, R14, R15	[0.52mm ² (20)]
RXE160	1.60	3.20	72	40	1.90	8.00	11.4	0.09	0.14	0.22	R10, R14, R15	[0.52mm ² (20)]
RXE185	1.85	3.70	72	40	2.10	9.25	12.6	0.08	0.12	0.19	R10, R14, R15	[0.52mm ² (20)]
RXE250	2.50	5.00	72	40	2.50	12.50	15.6	0.05	0.08	0.13	R10, R14, R15	[0.52mm ² (20)]
RXE300	3.00	6.00	72	40	2.80	15.00	19.8	0.04	0.06	0.10	R10, R14, R15	[0.52mm ² (20)]
RXE375	3.75	7.50	72	40	3.20	18.75	24.0	0.03	0.05	0.08	R10, R14, R15	[0.52mm ² (20)]

**RTE
33V**

New RTE120	1.20	2.3	33	40	0.78	6.0	3.5	0.074	0.12	0.18	R11, R14, R15	[0.205mm ² (24)]
New RTE135	1.35	2.5	33	40	0.84	6.75	4.5	0.059	0.10	0.143	R11, R14, R15	[0.205mm ² (24)]
New RTE190	1.90	3.0	33	40	0.90	9.5	3.5	0.045	0.063	0.092	R11, R14, R15	[0.205mm ² (24)]

Table R3. Electrical Characteristics for Radial-leaded Devices *continued*

Part Number	I _H (A)	I _T (A)	V _{MAX} (V)	I _{MAX} (A)	P _{D TYP} (W)	Max. Time-to-trip		R _{MIN} (Ω)	R _{MAX} (Ω)	R _{1 MAX} (Ω)	Figures for Dimensions	Lead Size [mm ² (AWG)]	
						(A)	(s)						
RUE													
30V													
RUE090	0.90	1.8	30	40	0.6	4.5	5.9	0.070	0.12	0.22	R11, R14, R15	[0.205mm ² (24)]	
RUE110	1.10	2.2	30	40	0.7	5.5	6.6	0.050	0.10	0.17	R11, R14, R15	[0.205mm ² (24)]	
RUE135	1.35	2.7	30	40	0.8	6.75	7.3	0.040	0.08	0.13	R11, R14, R15	[0.205mm ² (24)]	
RUE160	1.60	3.2	30	40	0.9	8.5	8.0	0.030	0.07	0.11	R11, R14, R15	[0.205mm ² (24)]	
RUE185	1.85	3.7	30	40	1.0	9.25	8.7	0.030	0.06	0.09	R11, R14, R15	[0.205mm ² (24)]	
RUE250	2.5	5.0	30	40	1.2	12.5	10.3	0.020	0.04	0.07	R11, R14, R15	[0.205mm ² (24)]	
RUE300	3.0	6.0	30	40	2.0	15.0	10.8	0.020	0.05	0.08	R12, R14, R15	[0.52mm ² (20)]	
RUE400	4.0	8.0	30	40	2.5	20.0	12.7	0.010	0.03	0.05	R12, R14, R15	[0.52mm ² (20)]	
RUE500	5.0	10.0	30	40	3.0	25.0	14.5	0.010	0.03	0.05	R12, R14, R15	[0.52mm ² (20)]	
RUE600	6.0	12.0	30	40	3.5	30.0	16.0	0.005	0.02	0.04	R12, R14, R15	[0.52mm ² (20)]	
RUE700	7.0	14.0	30	40	3.8	35.0	17.5	0.005	0.02	0.03	R12, R14, R15	[0.52mm ² (20)]	
RUE800	8.0	16.0	30	40	4.0	40.0	18.8	0.005	0.013	0.02	R12, R14, R15	[0.52mm ² (20)]	
RUE900	9.0	18.0	30	40	4.2	45.0	20.0	0.005	0.01	0.02	R12, R14, R15	[0.52mm ² (20)]	
RGE, RUSB													
16V													
RUSB090	0.90	1.8	16	40	0.6	8.0	1.2	0.070	0.120	0.180	R11, R14, R15	[0.205mm ² (24)]	
RUSB110	1.10	2.2	16	40	0.7	8.0	2.3	0.050	0.095	0.140	R11, R14, R15	[0.205mm ² (24)]	
RUSB135	1.35	2.7	16	40	0.8	8.0	4.5	0.040	0.074	0.115	R11, R14, R15	[0.205mm ² (24)]	
RUSB160	1.60	3.2	16	40	0.9	8.0	9.0	0.030	0.061	0.110	R11, R14, R15	[0.205mm ² (24)]	
RUSB185	1.85	3.7	16	40	1.0	8.0	10.0	0.030	0.051	0.090	R11, R14, R15	[0.205mm ² (24)]	
RUSB250	2.5	5.0	16	40	1.2	8.0	40.0	0.020	0.036	0.060	R11, R14, R15	[0.205mm ² (24)]	
RGE													
16V													
New	RGE250 †	2.5	4.7	16	100	1.0	12.5	5.0	0.022	0.035	0.053	R11, R14, R15	[0.205mm ² (24)]
	RGE300 †	3.0	5.1	16	100	2.3	15.0	1.0	0.038	0.0645	0.0975	R12, R14, R15	[0.52mm ² (20)]
	RGE400 †	4.0	6.8	16	100	2.4	20.0	1.7	0.021	0.0385	0.0600	R12, R14, R15	[0.52mm ² (20)]
	RGE500 †	5.0	8.5	16	100	2.6	25.0	2.0	0.015	0.0230	0.0340	R12, R14, R15	[0.52mm ² (20)]
	RGE600 †	6.0	10.2	16	100	2.8	30.0	3.3	0.010	0.0185	0.0280	R12, R14, R15	[0.52mm ² (20)]
	RGE700 †	7.0	11.9	16	100	3.0	35.0	3.5	0.0077	0.0130	0.0200	R12, R14, R15	[0.52mm ² (20)]
	RGE800 †	8.0	13.6	16	100	3.0	40.0	5.0	0.0056	0.0110	0.0175	R12, R14, R15	[0.52mm ² (20)]
	RGE900 †	9.0	15.3	16	100	3.3	45.0	5.5	0.0047	0.0092	0.0135	R12, R14, R15	[0.52mm ² (20)]
	RGE1000 †	10.0	17.0	16	100	3.6	50.0	6.0	0.0040	0.0071	0.0102	R12, R14, R15	[0.52mm ² (20)]
	RGE1100 †	11.0	18.7	16	100	3.7	55.0	7.0	0.0037	0.0062	0.0089	R12, R14, R15	[0.52mm ² (20)]
	RGE1200 †	12.0	20.4	16	100	4.2	60.0	7.5	0.0033	0.00595	0.0086	R12, R14, R15	[0.823mm ² (18)]
	RGE1400 †	14.0	23.8	16	100	4.6	70.0	9.0	0.0026	0.00445	0.0064	R12, R14, R15	[0.823mm ² (18)]

†Electrical characteristics determined at 25°C.

Table R3. Electrical Characteristics for Radial-leaded Devices *continued*

Part Number	I_H (A)	I_T (A)	V_{MAX} (V)	I_{MAX} (A)	P_D TYP (W)	Max. Time-to-trip (A) (s)		R_{MIN} (Ω)	R_{MAX} (Ω)	R_{1MAX} (Ω)	Figures for Dimensions	Lead Size [mm ² (AWG)]
RHE High Temperature 16V												
New RHE070 †	0.7	1.4	16	40	1.4	3.5	4.0	0.300	0.5400	0.800	R11, R14, R15	[0.205mm ² (24)]
New RHE400 †	4.0	7.0	16	100	2.0	20.0	8.0	0.018	0.029	0.044	R13, R14, R15	[0.205mm ² (24)]
New RHE450 †	4.5	7.8	16	100	3.6	22.5	3.0	0.022	0.0355	0.054	R13, R14, R15	[0.579mm ² (20)]
New RHE600 †	6.0	10.8	16	100	4.1	30.0	5.0	0.013	0.0215	0.032	R13, R14, R15	[0.579mm ² (20)]
New RHE650 †	6.5	12.0	16	100	4.3	32.5	5.5	0.011	0.0175	0.026	R13, R14, R15	[0.579mm ² (20)]
New RHE750 †	7.5	13.1	16	100	4.5	37.5	7.0	0.0094	0.0150	0.022	R13, R14, R15	[0.579mm ² (20)]
New RHE1000 †	10.0	18.5	16	100	5.3	50.0	9.0	0.0062	0.0103	0.015	R13, R14, R15	[0.579mm ² (20)]
New RHE1300 †	13.0	24.0	16	100	6.9	65.0	13.0	0.0041	0.0068	0.010	R13, R14, R15	[0.823mm ² (18)]
New RHE1500 †	15.0	28.0	16	100	7.0	75.0	20.0	0.0032	0.0063	0.0092	R13, R14, R15	[0.823mm ² (18)]

**RUSB
6V**

RUSB075	0.75	1.30	6	40	0.3	0.8	0.4	0.110	0.175	0.23	R9, R14, R15	[0.205mm ² (24)]
RUSB120	1.20	2.00	6	40	0.6	0.8	0.5	0.065	0.0975	0.14	R9, R14, R15	[0.205mm ² (24)]
New RUSB155	1.55	2.65	6	40	0.6	0.8	0.5	0.043	0.0705	0.10	R9, R14, R15	[0.205mm ² (24)]

Notes:

I_H = Hold current: maximum current device will pass without interruption in 20°C still air.

I_T = Trip current: minimum current that will switch the device from low resistance to high resistance in 20°C still air.

R_{MIN} = Minimum resistance of device as supplied at 20°C unless otherwise specified.

R_{MAX} = Maximum resistance of device as supplied at 20°C unless otherwise specified.

V_{MAX} = Maximum voltage device can withstand without damage at rated current.

I_{MAX} = Maximum fault current device can withstand without damage at rated voltage.

P_D = Power dissipated from device when in the tripped state in 20°C still air.

R_{1MAX} = Maximum resistance of device when measured one hour post reflow (surface-mount device) or one hour post trip (radial leaded device) at 20°C unless otherwise specified.

†Electrical characteristics determined at 25°C.

Figures R5-R15. Physical Description for Dimensions for Radial-led Devices

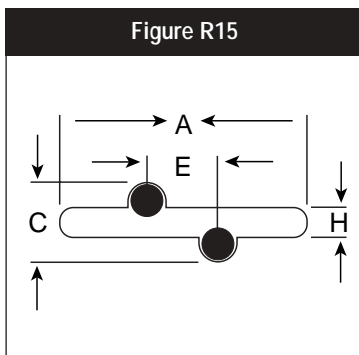
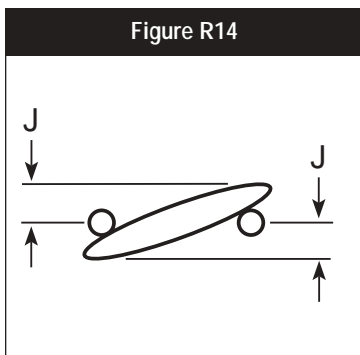
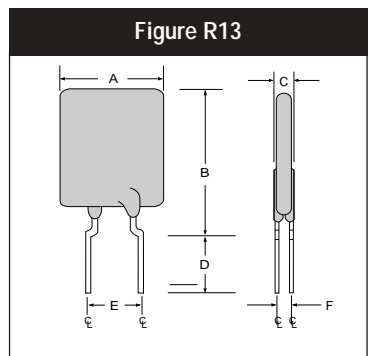
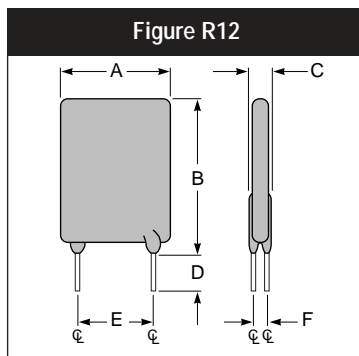
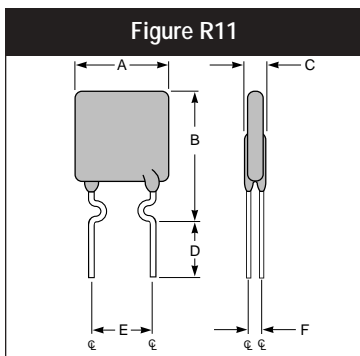
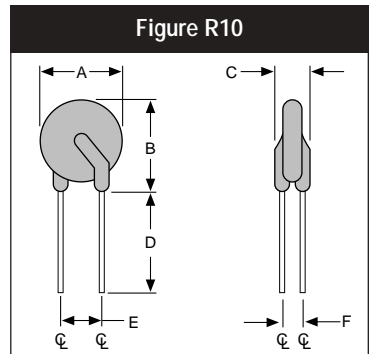
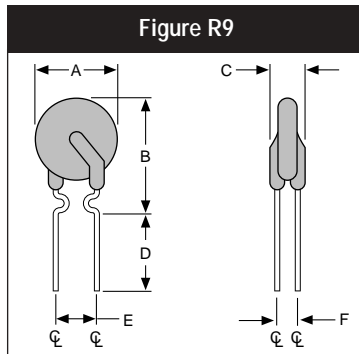
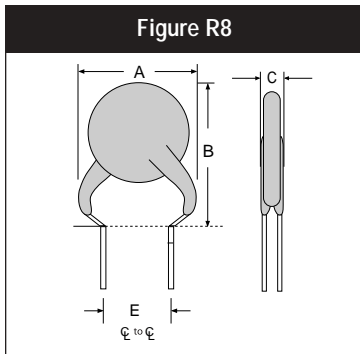
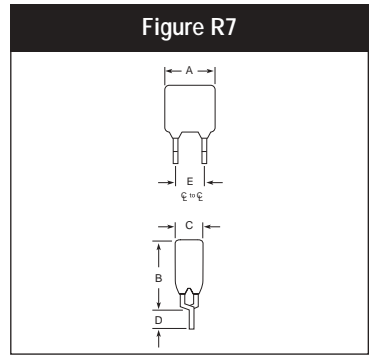
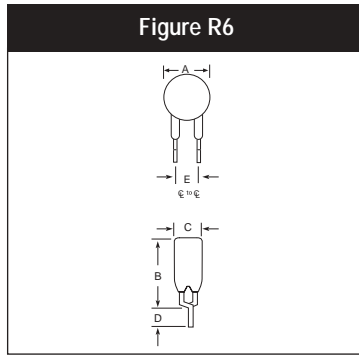
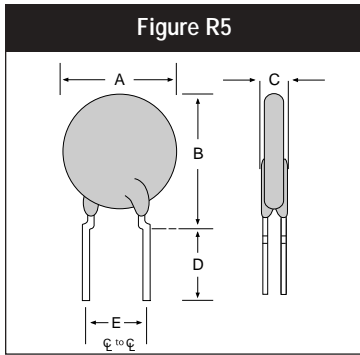

4

Table R4. Dimensions for Radial-led Devices in Millimeters (Inches)

Part Number	Dimension														Figures
	A		B		C		D		E		F	H	J		
	Min.	Max.	Min.	Max.	Min.	Max.	Min.	Max.	Min.	Max.	Typ.	Typ.	Typ.		
BBR															
90V															
BBR550	—	10.9 (0.43)	—	14.0 (0.55)	—	3.6 (0.14)	7.6 (0.3)	—	4.3 (0.17)	5.8 (0.23)	—	1.37 (0.054)	1.2 (0.05)	R5, R14, R15	
BBR750	—	11.9 (0.47)	—	15.5 (0.61)	—	3.6 (0.14)	7.6 (0.3)	—	4.3 (0.17)	5.8 (0.23)	—	1.37 (0.054)	1.2 (0.05)	R5, R14, R15	
TR250, TR600															
60/600V															
TR250-080U	—	4.8 (0.189)	—	9.3 (0.366)	—	3.8 (0.15)	4.7 (0.185)	—	5.00* (0.197)	—	—	—	—	R6	
TR250-120	—	6.5 (0.256)	—	11.0 (0.433)	—	4.6 (0.180)	4.7 (0.185)	—	5.00 (0.197)	—	—	—	—	R7	
TR250-145	—	6.5 (0.256)	—	11.0 (0.433)	—	4.6 (0.180)	4.7 (0.185)	—	5.00* (0.197)	—	—	—	—	R7	
TR250-180U	—	10.4 (0.410)	—	12.6 (0.495)	—	3.6 (0.140)	4.7 (0.185)	—	5.00* (0.197)	—	—	—	—	R7	
TR600-150	—	13.5 (0.531)	—	12.6 (0.495)	—	6.0 (0.236)	4.7 (0.185)	—	5.00* (0.197)	—	—	—	—	R7	
TR600-160	—	16.0 (0.630)	—	12.6 (0.495)	—	6.0 (0.236)	4.7 (0.185)	—	5.00* (0.197)	—	—	—	—	R7	
*Indicates dimension is typical, not minimum.															
RXE															
60V															
RXE005	—	8.0 (0.32)	—	8.3 (0.33)	—	3.0 (0.12)	7.6 (0.30)	—	4.3 (0.17)	5.8 (0.23)	—	1.07 (0.04)	1.0 (0.04)	R8, R14, R15	
RXE010	—	7.4 (0.29)	—	11.6 (0.46)	—	3.0 (0.12)	7.6 (0.30)	—	4.3 (0.17)	5.8 (0.23)	—	1.07 (0.042)	1.0 (0.04)	R9, R14, R15	
RXE017	—	7.4 (0.29)	—	12.7 (0.50)	—	3.0 (0.12)	7.6 (0.30)	—	4.3 (0.17)	5.8 (0.23)	—	1.68 (0.066)	1.7 (0.07)	R9, R14, R15	
RXE															
72V															
RXE020	—	7.4 (0.29)	—	11.7 (0.46)	—	3.0 (0.12)	7.6 (0.30)	—	4.3 (0.17)	5.8 (0.23)	—	1.17 (0.046)	1.0 (0.04)	R9, R14, R15	
RXE025	—	7.4 (0.29)	—	12.7 (0.50)	—	3.0 (0.12)	7.6 (0.30)	—	4.3 (0.17)	5.8 (0.23)	—	1.17 (0.046)	1.0 (0.04)	R9, R14, R15	
RXE030	—	7.4 (0.29)	—	12.7 (0.50)	—	3.0 (0.12)	7.6 (0.30)	—	4.3 (0.17)	5.8 (0.23)	—	1.17 (0.046)	1.0 (0.04)	R9, R14, R15	
RXE040	—	7.6 (0.30)	—	13.5 (0.53)	—	3.0 (0.12)	7.6 (0.30)	—	4.3 (0.17)	5.8 (0.23)	—	1.17 (0.046)	1.2 (0.05)	R9, R14, R15	
RXE050	—	7.9 (0.31)	—	13.7 (0.54)	—	3.0 (0.12)	7.6 (0.30)	—	4.3 (0.17)	5.8 (0.23)	—	1.17 (0.046)	1.2 (0.05)	R9, R14, R15	
RXE065	—	9.4 (0.37)	—	14.5 (0.57)	—	3.0 (0.12)	7.6 (0.30)	—	4.3 (0.17)	5.8 (0.23)	—	1.17 (0.046)	1.5 (0.06)	R9, R14, R15	
RXE075	—	10.2 (0.40)	—	15.2 (0.60)	—	3.0 (0.12)	7.6 (0.30)	—	4.3 (0.17)	5.8 (0.23)	—	1.17 (0.046)	1.5 (0.06)	R9, R14, R15	
RXE090	—	11.2 (0.44)	—	15.8 (0.62)	—	3.0 (0.12)	7.6 (0.30)	—	4.3 (0.17)	5.8 (0.23)	—	1.17 (0.046)	1.5 (0.06)	R9, R14, R15	
RXE110	—	12.8 (0.50)	—	17.5 (0.69)	—	3.0 (0.12)	7.6 (0.30)	—	4.3 (0.17)	5.8 (0.23)	—	1.37 (0.054)	1.2 (0.05)	R10, R14, R15	
RXE135	—	14.5 (0.57)	—	19.1 (0.75)	—	3.0 (0.12)	7.6 (0.30)	—	4.3 (0.17)	5.8 (0.23)	—	1.37 (0.054)	1.2 (0.05)	R10, R14, R15	
RXE160	—	16.3 (0.64)	—	20.8 (0.82)	—	3.0 (0.12)	7.6 (0.30)	—	4.3 (0.17)	5.8 (0.23)	—	1.37 (0.054)	1.5 (0.06)	R10, R14, R15	
RXE185	—	17.5 (0.69)	—	22.4 (0.88)	—	3.0 (0.12)	7.6 (0.30)	—	4.3 (0.17)	5.8 (0.23)	—	1.37 (0.054)	1.5 (0.06)	R10, R14, R15	
RXE250	—	20.8 (0.82)	—	25.4 (1.00)	—	3.0 (0.12)	7.6 (0.30)	—	9.4 (0.37)	10.9 (0.43)	—	1.37 (0.054)	1.7 (0.07)	R10, R14, R15	

Table R4. Dimensions for Radial-led Devices in Millimeters (Inches) *continued*

Part Number	Dimension														Figures
	A		B		C		D		E		F	H	J		
	Min.	Max.	Min.	Max.	Min.	Max.	Min.	Max.	Min.	Max.	Typ.	Typ.	Typ.		
RXE continued															
72V															
RXE300	—	23.9 (0.94)	—	28.6 (1.13)	—	3.0 (0.12)	7.6 (0.30)	—	9.4 (0.37)	10.9 (0.43)	—	1.37 (0.054)	1.7 (0.07)	R10, R14, R15	
RXE375	—	27.2 (1.07)	—	31.8 (1.25)	—	3.0 (0.12)	7.6 (0.30)	—	9.4 (0.37)	10.9 (0.43)	—	1.37 (0.054)	1.7 (0.07)	R10, R14, R15	
RTE															
33V															
RTE120	—	7.4 (0.29)	—	12.2 (0.48)	—	3.0 (0.12)	7.6 (0.30)	—	4.3 (0.17)	5.8 (0.23)	—	0.89 (0.035)	0.8 (0.03)	R11, R14, R15	
RTE135	—	7.4 (0.29)	—	14.2 (0.56)	—	3.0 (0.12)	7.6 (0.30)	—	4.3 (0.17)	5.8 (0.23)	—	0.89 (0.035)	0.8 (0.03)	R11, R14, R15	
RTE190	—	8.9 (0.35)	—	13.5 (0.53)	—	3.0 (0.12)	7.6 (0.30)	—	4.3 (0.17)	5.8 (0.23)	—	0.89 (0.035)	1.0 (0.04)	R11, R14, R15	
RUE															
30V															
RUE090	—	7.4 (0.29)	—	12.2 (0.48)	—	3.0 (0.12)	7.6 (0.30)	—	4.3 (0.17)	5.8 (0.23)	—	0.89 (0.035)	0.8 (0.03)	R11, R14, R15	
RUE110	—	7.4 (0.29)	—	14.2 (0.56)	—	3.0 (0.12)	7.6 (0.30)	—	4.3 (0.17)	5.8 (0.23)	—	0.89 (0.035)	0.8 (0.03)	R11, R14, R15	
RUE135	—	8.9 (0.35)	—	13.5 (0.53)	—	3.0 (0.12)	7.6 (0.30)	—	4.3 (0.17)	5.8 (0.23)	—	0.89 (0.035)	1.0 (0.04)	R11, R14, R15	
RUE160	—	8.9 (0.35)	—	15.2 (0.60)	—	3.0 (0.12)	7.6 (0.30)	—	4.3 (0.17)	5.8 (0.23)	—	0.89 (0.035)	1.0 (0.04)	R11, R14, R15	
RUE185	—	10.2 (0.40)	—	15.7 (0.62)	—	3.0 (0.12)	7.6 (0.30)	—	4.3 (0.17)	5.8 (0.23)	—	0.89 (0.035)	1.0 (0.04)	R11, R14, R15	
RUE250	—	11.4 (0.45)	—	18.3 (0.72)	—	3.0 (0.12)	7.6 (0.30)	—	4.3 (0.17)	5.8 (0.23)	—	0.89 (0.035)	1.2 (0.05)	R11, R14, R15	
RUE300	—	11.4 (0.45)	—	16.5 (0.65)	—	3.0 (0.12)	7.6 (0.30)	—	4.3 (0.17)	5.8 (0.23)	—	1.19 (0.047)	1.5 (0.06)	R12, R14, R15	
RUE400	—	14.0 (0.55)	—	19.3 (0.76)	—	3.0 (0.12)	7.6 (0.30)	—	4.3 (0.17)	5.8 (0.23)	—	1.19 (0.047)	1.7 (0.07)	R12, R14, R15	
RUE500	—	14.0 (0.55)	—	24.1 (0.95)	—	3.0 (0.12)	7.6 (0.30)	—	9.4 (0.37)	10.9 (0.43)	—	1.19 (0.047)	1.0 (0.04)	R12, R14, R15	
RUE600	—	16.5 (0.65)	—	24.1 (0.95)	—	3.0 (0.12)	7.6 (0.30)	—	9.4 (0.37)	10.9 (0.43)	—	1.19 (0.047)	1.0 (0.04)	R12, R14, R15	
RUE700	—	19.1 (0.75)	—	25.9 (1.02)	—	3.0 (0.12)	7.6 (0.30)	—	9.4 (0.37)	10.9 (0.43)	—	1.19 (0.047)	1.2 (0.05)	R12, R14, R15	
RUE800	—	21.6 (0.85)	—	28.4 (1.12)	—	3.0 (0.12)	7.6 (0.30)	—	9.4 (0.37)	10.9 (0.43)	—	1.19 (0.047)	1.5 (0.06)	R12, R14, R15	
RUE900	—	24.1 (0.95)	—	29.0 (1.14)	—	3.0 (0.12)	7.6 (0.30)	—	9.4 (0.37)	10.9 (0.43)	—	1.19 (0.047)	1.5 (0.06)	R12, R14, R15	
RUSB															
16V															
RUSB090	—	7.4 (0.29)	—	12.2 (0.48)	—	3.0 (0.12)	7.6 (0.30)	—	4.3 (0.17)	5.8 (0.23)	—	0.89 (0.035)	0.8 (0.03)	R11, R14, R15	
RUSB110	—	7.4 (0.29)	—	14.2 (0.56)	—	3.0 (0.12)	7.6 (0.30)	—	4.3 (0.17)	5.8 (0.23)	—	0.89 (0.035)	0.8 (0.03)	R11, R14, R15	
RUSB135	—	8.9 (0.35)	—	13.5 (0.53)	—	3.0 (0.12)	7.6 (0.30)	—	4.3 (0.17)	5.8 (0.23)	—	0.89 (0.035)	1.0 (0.04)	R11, R14, R15	
RUSB160	—	8.9 (0.35)	—	15.2 (0.60)	—	3.0 (0.12)	7.6 (0.30)	—	4.3 (0.17)	5.8 (0.23)	—	0.89 (0.035)	1.0 (0.04)	R11, R14, R15	
RUSB185	—	10.2 (0.40)	—	15.7 (0.62)	—	3.0 (0.12)	7.6 (0.30)	—	4.3 (0.17)	5.8 (0.23)	—	0.89 (0.035)	1.0 (0.04)	R11, R14, R15	
RUSB250	—	11.4 (0.45)	—	18.3 (0.72)	—	3.0 (0.12)	7.6 (0.30)	—	4.3 (0.17)	5.8 (0.23)	—	0.89 (0.035)	1.2 (0.05)	R11, R14, R15	

Table R4. Dimensions for Radial-led Devices in Millimeters (Inches) *continued*

Part Number	Dimension													Figures
	A		B		C		D		E		F	H	J	
	Min.	Max.	Min.	Max.	Min.	Max.	Min.	Max.	Min.	Max.	Typ.	Typ.	Typ.	
RGE														
16V														
RGE250	—	8.4 (0.35)	—	12.8 (0.50)	—	3.0 (0.12)	3.18 (0.13)	6.18 (0.24)	4.3 (0.17)	5.8 (0.23)	1.2 (0.05)	1.24 (0.049)	1.2 (0.05)	R11, R14, R15
RGE300	6.1 (0.24)	7.1 (0.28)	6.1 (0.24)	11.0 (0.43)	2.0 (0.08)	3.0 (0.12)	7.6 (0.30)	—	4.3 (0.17)	5.8 (0.23)	1.2 (0.05)	1.24 (0.049)	1.2 (0.05)	R12, R14, R15
RGE400	7.9 (0.31)	8.9 (0.35)	7.9 (0.31)	12.8 (0.50)	2.0 (0.08)	3.0 (0.12)	7.6 (0.30)	—	4.3 (0.17)	5.8 (0.23)	1.2 (0.05)	1.24 (0.049)	1.4 (0.055)	R12, R14, R15
RGE500	9.4 (0.37)	10.4 (0.41)	9.4 (0.37)	14.3 (0.56)	2.0 (0.08)	3.0 (0.12)	7.6 (0.30)	—	4.3 (0.17)	5.8 (0.23)	1.2 (0.05)	1.24 (0.049)	1.6 (0.06)	R12, R14, R15
RGE600	9.7 (0.38)	10.7 (0.42)	12.2 (0.48)	17.1 (0.67)	2.0 (0.08)	3.0 (0.12)	7.6 (0.30)	—	4.3 (0.17)	5.8 (0.23)	1.2 (0.05)	1.24 (0.049)	1.6 (0.06)	R12, R14, R15
RGE700	10.2 (0.40)	11.2 (0.44)	14.7 (0.58)	19.7 (0.78)	2.0 (0.08)	3.0 (0.12)	7.6 (0.30)	—	4.3 (0.17)	5.8 (0.23)	1.2 (0.05)	1.24 (0.049)	1.7 (0.067)	R12, R14, R15
RGE800	11.7 (0.46)	12.7 (0.50)	16.0 (0.63)	20.9 (0.82)	2.0 (0.08)	3.0 (0.12)	7.6 (0.30)	—	4.3 (0.17)	5.8 (0.23)	1.2 (0.05)	1.24 (0.049)	1.8 (0.07)	R12, R14, R15
RGE900	13.0 (0.51)	14.0 (0.55)	16.8 (0.66)	21.7 (0.85)	2.0 (0.08)	3.0 (0.12)	7.6 (0.30)	—	4.3 (0.17)	5.8 (0.23)	1.2 (0.05)	1.24 (0.049)	2.0 (0.08)	R12, R14, R15
RGE1000	15.5 (0.61)	16.5 (0.65)	21.1 (0.83)	25.2 (0.99)	2.0 (0.08)	3.0 (0.12)	7.6 (0.30)	—	4.3 (0.17)	5.8 (0.23)	1.2 (0.05)	1.24 (0.049)	2.0 (0.08)	R12, R14, R15
RGE1100	16.5 (0.65)	17.5 (0.69)	21.1 (0.83)	26.0 (1.02)	2.0 (0.08)	3.0 (0.12)	7.6 (0.30)	—	4.3 (0.17)	5.8 (0.23)	1.2 (0.05)	1.24 (0.049)	2.4 (0.09)	R12, R14, R15
RGE1200	16.4 (0.65)	17.5 (0.69)	22.6 (0.89)	28.0 (1.10)	2.3 (0.09)	3.5 (0.14)	7.6 (0.30)	—	9.4 (0.37)	10.9 (0.43)	1.4 (0.06)	1.45 (0.057)	1.5 (0.06)	R12, R14, R15
RGE1400	22.4 (0.88)	23.5 (0.925)	22.6 (0.89)	27.9 (1.10)	2.3 (0.09)	3.5 (0.14)	7.6 (0.30)	—	9.4 (0.37)	10.9 (0.43)	1.4 (0.06)	1.45 (0.057)	1.9 (0.075)	R12, R14, R15
RHE High Temperature														
16V														
RHE070	—	6.86 (0.27)	—	10.8 (0.425)	—	3.0 (0.12)	7.6 (0.30)	—	4.31 (0.17)	5.84 (0.23)	1.27 (0.05)	1.24 (0.049)	1.2 (0.05)	R11, R14, R15
RHE400	—	11.4 (0.45)	—	18.0 (0.71)	—	3.0 (0.12)	7.6 (0.30)	—	4.3 (0.17)	5.8 (0.23)	1.2 (0.05)	1.24 (0.049)	1.6 (0.06)	R13, R14, R15
RHE450	—	10.4 (0.41)	—	15.6 (0.61)	—	3.0 (0.12)	7.6 (0.30)	—	4.3 (0.17)	5.8 (0.23)	1.2 (0.05)	1.24 (0.049)	1.6 (0.06)	R13, R14, R15
RHE600	—	11.2 (0.44)	—	21.0 (0.83)	—	3.0 (0.12)	7.6 (0.30)	—	4.3 (0.17)	5.8 (0.23)	1.2 (0.05)	1.24 (0.049)	1.7 (0.067)	R13, R14, R15
RHE650	—	12.7 (0.50)	—	22.2 (0.88)	—	3.0 (0.12)	7.6 (0.30)	—	4.3 (0.17)	5.8 (0.23)	1.2 (0.05)	1.24 (0.049)	1.8 (0.07)	R13, R14, R15
RHE750	—	14.0 (0.55)	—	23.5 (0.93)	—	3.0 (0.12)	7.6 (0.30)	—	4.3 (0.17)	5.8 (0.23)	1.2 (0.05)	1.24 (0.049)	2.0 (0.08)	R13, R14, R15
RHE1000	—	17.5 (0.69)	—	26.5 (1.04)	—	3.0 (0.12)	7.6 (0.30)	—	9.4 (0.37)	10.9 (0.43)	1.2 (0.05)	1.24 (0.049)	1.5 (0.06)	R13, R14, R15
RHE1300	—	23.5 (0.925)	—	28.7 (1.13)	—	3.6 (0.14)	7.6 (0.30)	—	9.4 (0.37)	10.9 (0.43)	1.4 (0.06)	1.45 (0.057)	1.9 (0.084)	R13, R14, R15
RHE1500	—	23.5 (0.925)	—	28.7 (1.13)	—	3.6 (0.14)	7.6 (0.30)	—	9.4 (0.37)	10.9 (0.43)	1.4 (0.06)	1.45 (0.057)	1.9 (0.084)	R13, R14, R15
RUSB														
6V														
RUSB075	—	6.9 (0.27)	—	11.4 (0.45)	—	3.1 (0.12)	7.6 (0.30)	—	4.3 (0.17)	5.9 (0.23)	—	0.91 (0.036)	1.0 (0.04)	R9, R14, R15
RUSB120	—	6.9 (0.27)	—	11.7 (0.46)	—	3.1 (0.12)	7.6 (0.30)	—	4.3 (0.17)	5.9 (0.23)	—	0.91 (0.036)	1.0 (0.04)	R9, R14, R15
RUSB155	—	6.9 (0.27)	—	11.7 (0.46)	—	3.1 (0.12)	7.6 (0.30)	—	4.3 (0.17)	5.9 (0.23)	—	0.91 (0.036)	1.0 (0.04)	R9, R14, R15

New

4

Figures R16–R21. Typical Time-to-trip Curves at 20°C for Radial-leaded Devices

BBR

A = BBR550

B = BBR750

RTE

C = RTE120

D = RTE135

E = RTE190

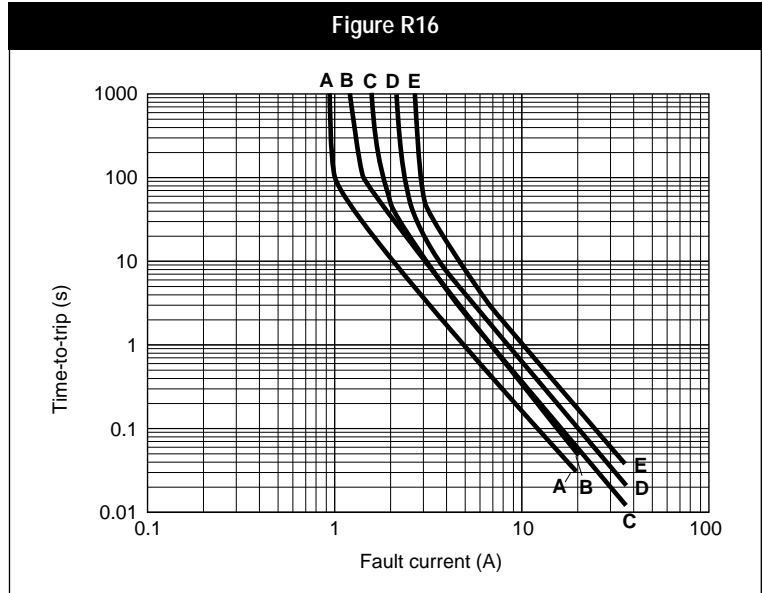

RXE

A = RXE005

J = RXE075

B = RXE010

K = RXE090

C = RXE017

L = RXE110

D = RXE020

M = RXE135

E = RXE025

N = RXE160

F = RXE030

O = RXE185

G = RXE040

P = RXE250

H = RXE050

Q = RXE300

I = RXE065

R = RXE375

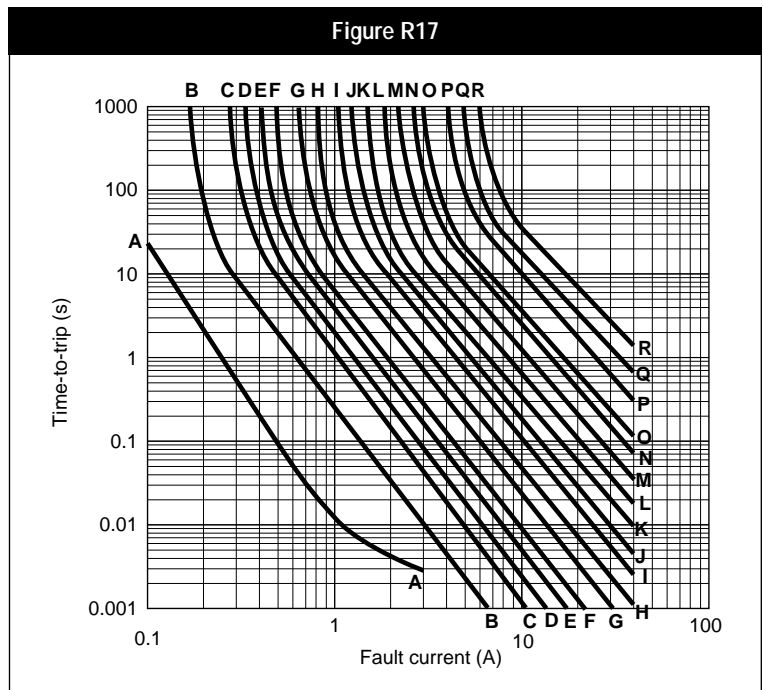

Figures R16–R21. Typical Time-to-trip Curves at 20°C for Radial-led Devices *continued*

RUE

- A = RUE090 H = RUE400
- B = RUE110 I = RUE500
- C = RUE135 J = RUE600
- D = RUE160 K = RUE700
- E = RUE185 L = RUE800
- F = RUE250 M = RUE900
- G = RUE300

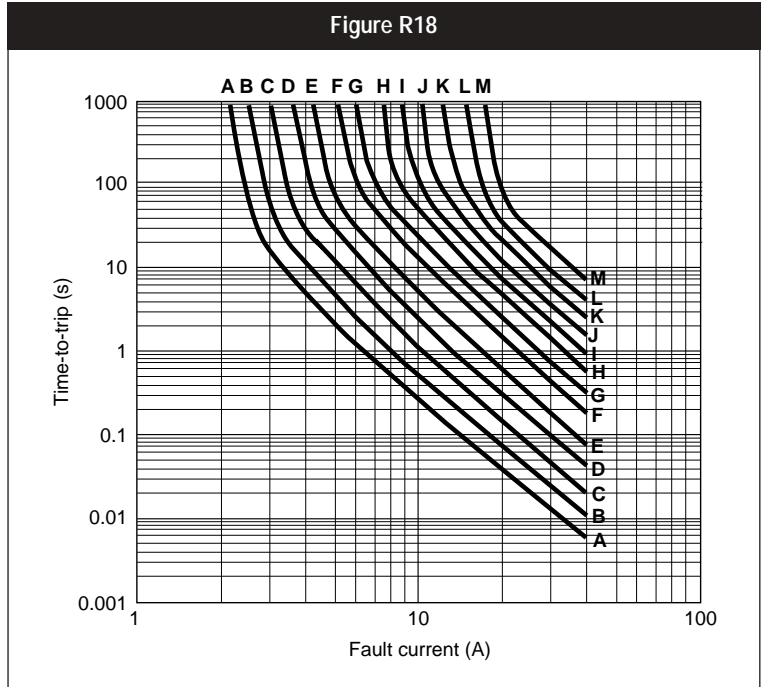

4

RGE (data at 25°C)

- A = RGE300 H = RGE1000
- B = RGE400 I = RGE1100
- C = RGE500 J = RGE1200
- D = RGE600 K = RGE1400
- E = RGE700
- F = RGE800
- G = RGE900

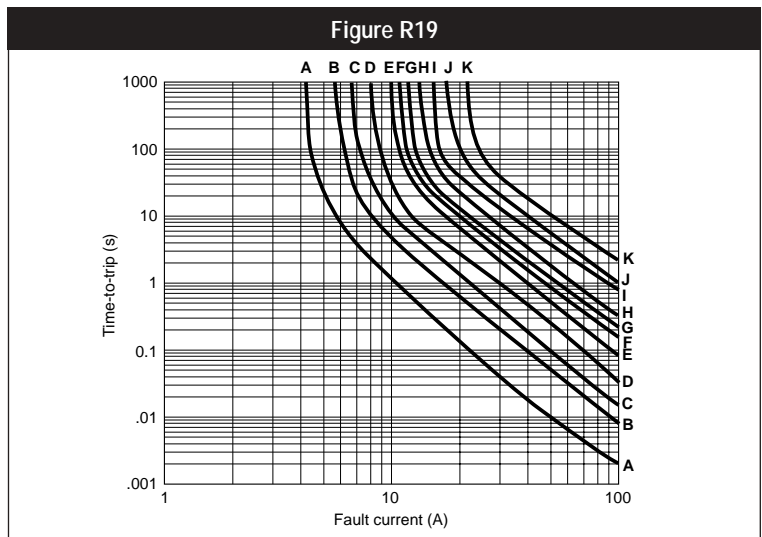

Figures R16–R21. Typical Time-to-trip Curves at 20°C for Radial-led Devices *continued*

RHE (data at 25°C)

- A = RHE070 F = RHE750
- B = RHE400 G = RHE1000
- C = RHE450 H = RHE1300
- D = RHE600 I = RHE1500
- E = RHE650

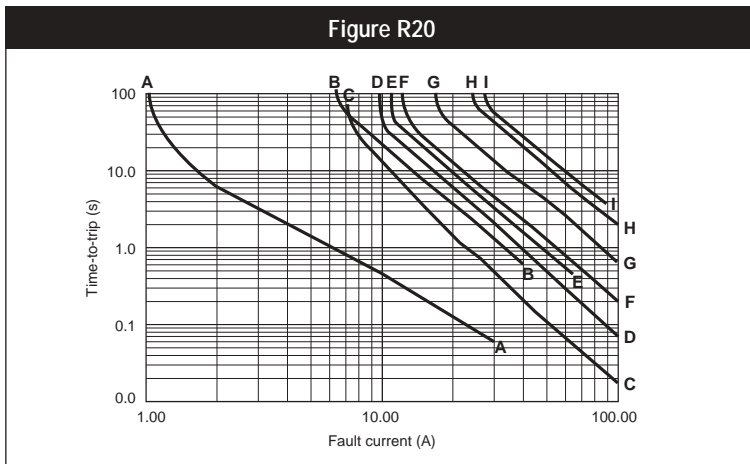

RUSB

- A = RUSB075 F = RUSB155
- B = RUSB090 G = RUSB160
- C = RUSB110 H = RUSB185
- D = RUSB120 I = RUSB250
- E = RUSB135

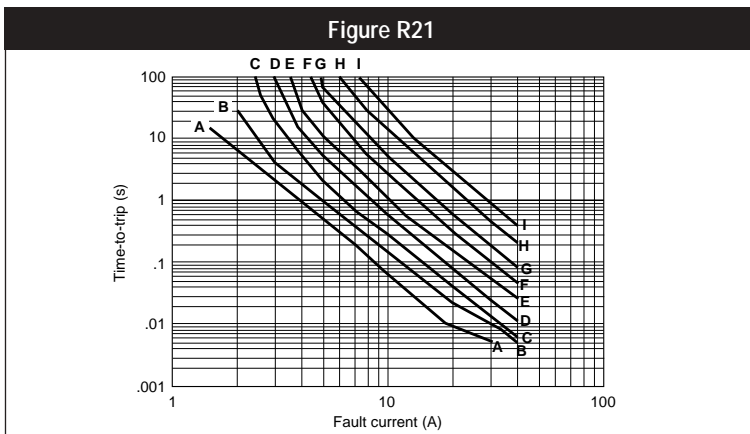

Table R5. Physical Characteristics and Environmental Specifications for Radial-leaded Devices

BBR

Physical Characteristics

Lead material	Tin/lead-plated copper, 0.52mm ² (20 AWG), ϕ 0.81mm (0.032 in.)
Soldering characteristics	Solderability per ANSI/J-STD-002 Category 3
Solder heat withstand	per IEC-STD 68-2-20, Test Tb, Method 1a, condition b; can withstand 10 seconds at 260°C \pm 5°C
Insulating material	Cured, flame-retardant epoxy polymer; meets UL 94V-0

Devices are not designed to be placed through a reflow process.

Environmental Specifications

Test	Conditions	Resistance Change
Passive aging	70°C, 1000 hours	\pm 5%
	85°C, 1000 hours	\pm 5%
Humidity aging	85°C, 85% RH, 1000 hours	\pm 5%
Thermal shock	85°C, -40°C (10 times)	\pm 5%
Solvent resistance	MIL-STD-202, Method 215F	No change

RXE

Physical Characteristics

Lead material	RXE005: Tin/lead-plated nickel-copper alloy, 0.128mm ² (26 AWG), ϕ 0.40mm (0.016 in.)
	RXE010: Tin/lead-plated nickel-copper alloy, 0.205mm ² (24 AWG), ϕ 0.51mm (0.020 in.)
	RXE017 to 040: Tin/lead-plated copper-clad steel, 0.205mm ² (24 AWG), ϕ 0.51mm (0.020 in.)
	RXE050 to 090: Tin/lead-plated copper, 0.205mm ² (24 AWG), ϕ 0.51mm (0.020 in.)
	RXE110 to 375: Tin/lead-plated copper, 0.52mm ² (20 AWG), ϕ 0.81mm (0.032 in.)

Soldering characteristics	Solderability per ANSI/J-STD-002 Category 3, except RXE005, RXE010 meet ANSI/J-STD-002 Category 1
Solder heat withstand	RXE017 – RXE025: per IEC-STD 68-2-20, Test Tb, Method 1a, condition a; can withstand 5 seconds at 260°C \pm 5°C All other sizes: per IEC-STD 68-2-20, Test Tb, Method 1a, condition b; can withstand 10 seconds at 260°C \pm 5°C
Insulating material	Cured, flame-retardant epoxy polymer; meets UL 94V-0

Devices are not designed to be placed through a reflow process.

Environmental Specifications

Test	Conditions	Resistance Change
Passive aging	-40°C, 1000 hours	\pm 5%
	85°C, 1000 hours	\pm 5%
Humidity aging	85°C, 85% RH, 1000 hours	\pm 10%
Thermal shock	85°C, -40°C (10 times)	\pm 10%
Solvent resistance	MIL-STD-202, Method 215F	No change



Table R5. Physical Characteristics and Environmental Specifications for Radial-leded Devices *continued*

RTE Physical Characteristics	
Lead material	Tin/lead-plated copper-clad steel, 0.205mm ² (24 AWG), ϕ 0.40mm (0.016 in.)
Soldering characteristics	Solderability per ANSI/J-STD-002 Category 3
Solder heat withstand	per IEC-STD 68-2-20, Test Tb, Method 1a, condition b; can withstand 10 seconds at 260°C \pm 5°C
Insulating material	Cured, flame-retardant epoxy polymer; meets UL 94V-0

Environmental Specifications

Test	Conditions	Resistance Change
Passive aging	70°C, 1000 hours	\pm 5%
	85°C, 1000 hours	\pm 5%
Humidity aging	85°C, 85% RH, 1000 hours	\pm 5%
Thermal shock	85°C, -40°C (10 times)	\pm 5%
Solvent resistance	MIL-STD-202, Method 215F	No change

**RUE
Physical Characteristics**

Lead material	RUE090 to RUE250: Tin/lead-plated copper-clad steel, 0.205mm ² (24 AWG)
	RUE300 to RUE900: Tin/lead-plated copper, 0.52mm ² (20 AWG), ϕ 0.81mm (0.032 in.)
Soldering characteristics	Solderability per ANSI/J-STD-002 Category 3
Solder heat withstand	per IEC-STD 68-2-20, Test Tb, Method 1a, condition b; can withstand 10 seconds at 260°C \pm 5°C
Insulating material	Cured, flame-retardant epoxy polymer; meets UL 94V-0

Devices are not designed to be placed through a reflow process.

Environmental Specifications

Test	Conditions	Resistance Change
Passive aging	70°C, 1000 hours	\pm 5%
	85°C, 1000 hours	\pm 5%
Humidity aging	85°C, 85% RH, 1000 hours	\pm 5%
Thermal shock	85°C, -40°C (10 times)	\pm 5%
Solvent resistance	MIL-STD-202, Method 215F	No change

**RUSB
Physical Characteristics**

Lead material	RUSB075: Tin/lead-plated nickel-copper alloy, 0.205mm ² (24 AWG) ϕ 0.51 mm/0.020 in.
	RUSB090 to RUSB250: Tin/lead-plated copper clad-steel, 0.205mm ² (24 AWG) ϕ 0.51 mm/0.020 in.
Soldering characteristics	Solderability per ANSI/J-STD-002 Category 3 except RUSB075 meets ANSI/J-STD-002 Category 1
Solder heat withstand	RUSB120: per IEC 68-2-20, Test Tb, Method 1a, condition a; can withstand 5 seconds at 260°C \pm 5°C All others: per IEC 68-2-20, Test Tb, Method 1a, condition b; can withstand 10 seconds at 260°C \pm 5°C
Insulating material	Cured, flame-retardant epoxy polymer; meets UL 94V-0

Devices are not designed to be placed through a reflow process.

Environmental Specifications

Test	Conditions	Resistance Change
Passive aging	70°C, 1000 hours	\pm 5%
	85°C, 1000 hours	\pm 5%
Humidity aging	85°C, 85% RH, 1000 hours	\pm 5%
Thermal shock	85°C, -40°C (10 times)	\pm 5%
Solvent resistance	MIL-STD-202, Method 215F	No change

Table R5. Physical Characteristics and Environmental Specifications for Radial-led Devices *continued*

RGE
Physical Characteristics

Lead material	RGE300 to RGE1100: Tin/lead-plated copper, 0.52mm ² (20 AWG) ø 0.81 mm/0.032 in. RGE1200 and RGE1400: Tin/lead-plated copper, 0.82mm ² (18 AWG) ø 1.0 mm/0.04 in.
Soldering characteristics	Solderability per ANSI/J-STD 002 Category 3
Solder heat withstand	RGE300K and RGE400: per IEC 68-2-20, Test Tb, Method 1a, condition a; can withstand 5 seconds at 260°C ± 5°C RGE500 to RGE1400: per IEC 68-2-20 Test Tb, Method 1a, condition b; can withstand 10 seconds at 260°C ± 5°C
Insulating material	Cured, flame-retardant epoxy polymer; meets UL 94V-0

Devices are not designed to be placed through a reflow process.

Environmental Specifications

Test	Conditions	Resistance Change
Passive aging	-40°C, 1000 hours	± 5%
	85°C, 1000 hours	± 5%
Humidity aging	85°C, 85% RH, 1000 hours	± 5%
Thermal shock	85°C, -40°C (10 times)	± 5%
Solvent resistance	MIL-STD-202, Method 215F	No change

RHE
Physical Characteristics

Lead material	RHE070 and RHE400: Tin/lead -plated copper clad steel, 0.205mm ² (24 AWG) ø 0.51 mm/0.020 in. RHE450 to RHE1000: Tin/lead-plated copper, 0.52mm ² (20 AWG) ø 0.81 mm/0.032 in. RHE1300, RHE1500: Tin/lead-plated copper, 0.82mm ² (18 AWG) ø 1.0 mm/0.04 in.
Soldering characteristics	Solderability per ANSI/J-STD 002 Category 3
Solder heat withstand	Per IEC 68-2-20, Test Tb, Method 1a, condition b; can withstand 10 seconds at 260°C ± 5°C
Insulating material	Cured, flame-retardant epoxy polymer; meets UL 94V-0

Devices are not designed to be placed through a reflow process.

Environmental Specifications

Test	Conditions	Resistance Change
Passive aging	70°C, 1000 hours	± 5%
	85°C, 1000 hours	± 5%
Humidity aging	85°C, 85% RH, 1000 hours	± 5%
Thermal shock	125°C, -40°C (10 times)	± 5%
Solvent resistance	MIL-STD-202, Method 215F	No change

Devices are not designed to be placed through a reflow process.

Notes:

Storage conditions: 40°C max., 70% RH max.; devices should remain in original sealed bags prior to use. Devices may not meet specified values if these storage conditions are exceeded.

For the TR device series, see the Telecommunications and Networking section.

Agency recognitions for Radial-led Devices

UL	File # E74889
CSA	File # CA78165C
TÜV	Certificate number available on request (per IEC 60730-1).

Table R6. Packaging and Marking Information for Radial-led Devices

Part Number	Bag Quantity	Tape and Reel Quantity	Ammo Pack Quantity	Standard Package Quantity	Part Marking	Agency Recognition
BBR 90V						
BBR550	500	—	—	10,000	B550	UL, CSA
BBR550-2	—	1,500	—	7,500	B550	UL, CSA
BBR750	500	—	—	10,000	B750	UL, CSA
BBR750-2	—	1,500	—	7,500	B750	UL, CSA
TR250, TR600 60/600V						
TR250-080U	500	1,500	—	10,000/7,500	08	UL, CSA, TÜV
TR250-120	500	1,500	—	10,000/7,500	20	UL, CSA, TÜV
TR250-145	500	1,500	—	10,000/7,500	45	UL, CSA, TÜV
TR250-180U	500	1,500	—	10,000/7,500	80	UL, CSA, TÜV
TR600-150	500	600	—	10,000/3,000	150	UL, CSA
TR600-160	500	600	—	10,000/3,000	160	UL, CSA
RXE 60V						
RXE005	500	—	—	10,000	—	UL, CSA, TÜV
RXE010	500	—	—	10,000	X010	UL, CSA, TÜV
RXE010-2	—	3,000	—	15,000	X010	UL, CSA, TÜV
RXE010-AP	—	—	2,000	10,000	X010	UL, CSA, TÜV
RXE017	500	—	—	10,000	X017	UL, CSA, TÜV
RXE017-2	—	2,500	—	12,500	X017	UL, CSA, TÜV
RXE017-AP	—	—	2,000	10,000	X017	UL, CSA, TÜV
RXE 72V						
RXE020	500	—	—	10,000	X020	UL, CSA, TÜV
RXE020-2	—	3,000	—	15,000	X020	UL, CSA, TÜV
RXE020-AP	—	—	2,000	10,000	X020	UL, CSA, TÜV
RXE025	500	—	—	10,000	X025	UL, CSA, TÜV
RXE025-2	—	3,000	—	15,000	X025	UL, CSA, TÜV
RXE025-AP	—	—	2,000	10,000	X025	UL, CSA, TÜV
RXE030	500	—	—	10,000	X030	UL, CSA, TÜV
RXE030-2	—	3,000	—	15,000	X030	UL, CSA, TÜV
RXE030-AP	—	—	2,000	10,000	X030	UL, CSA, TÜV
RXE040	500	—	—	10,000	X040	UL, CSA, TÜV
RXE040-2	—	3,000	—	15,000	X040	UL, CSA, TÜV
RXE040-AP	—	—	2,000	10,000	X040	UL, CSA, TÜV
RXE050	500	—	—	10,000	X050	UL, CSA, TÜV
RXE050-2	—	3,000	—	15,000	X050	UL, CSA, TÜV
RXE050-AP	—	—	2,000	10,000	X050	UL, CSA, TÜV
RXE065	500	—	—	10,000	X065	UL, CSA, TÜV
RXE065-2	—	3,000	—	15,000	X065	UL, CSA, TÜV
RXE065-AP	—	—	2,000	10,000	X065	UL, CSA, TÜV
RXE075	500	—	—	10,000	X075	UL, CSA, TÜV

Table R6. Packaging and Marking Information for Radial-led Devices *continued*

Part Number	Bag Quantity	Tape and Reel Quantity	Ammo Pack Quantity	Standard Package Quantity	Part Marking	Agency Recognition
RXE 72V <i>continued</i>						
RXE075-2	—	3,000	—	15,000	X075	UL, CSA, TÜV
RXE075-AP	—	—	2,000	10,000	X075	UL, CSA, TÜV
RXE090	500	—	—	10,000	X090	UL, CSA, TÜV
RXE090-2	—	3,000	—	15,000	X090	UL, CSA, TÜV
RXE090-AP	—	—	2,000	10,000	X090	UL, CSA, TÜV
RXE110	500	—	—	10,000	X110	UL, CSA, TÜV
RXE110-2	—	1,500	—	7,500	X110	UL, CSA, TÜV
RXE110-AP	—	—	1,000	5,000	X110	UL, CSA, TÜV
RXE135	500	—	—	10,000	X135	UL, CSA, TÜV
RXE135-2	—	1,500	—	7,500	X135	UL, CSA, TÜV
RXE135-AP	—	—	1,000	5,000	X135	UL, CSA, TÜV
RXE160	500	—	—	10,000	X160	UL, CSA, TÜV
RXE160-2	—	1,500	—	7,500	X160	UL, CSA, TÜV
RXE160-AP	—	—	1,000	5,000	X160	UL, CSA, TÜV
RXE185	500	—	—	10,000	X185	UL, CSA, TÜV
RXE185-2	—	1,500	—	7,500	X185	UL, CSA, TÜV
RXE185-AP	—	—	1,000	5,000	X185	UL, CSA, TÜV
RXE250	250	—	—	5,000	X250	UL, CSA, TÜV
RXE250-2	—	1,000	—	5,000	X250	UL, CSA, TÜV
RXE250-AP	—	—	1,000	5,000	X250	UL, CSA, TÜV
RXE300	250	—	—	5,000	X300	UL, CSA, TÜV
RXE300-2	—	1,000	—	5,000	X300	UL, CSA, TÜV
RXE300-AP	—	—	1,000	5,000	X300	UL, CSA, TÜV
RXE375	250	—	—	5,000	X375	UL, CSA, TÜV
RTE 33V						
RTE120	500	—	—	10,000	T120	UL, CSA, TÜV
RTE120-2	—	3,000	—	15,000	T120	UL, CSA, TÜV
RTE120-AP	—	—	2,000	10,000	T120	UL, CSA, TÜV
RTE135	500	—	—	10,000	T135	UL, CSA, TÜV
RTE135-2	—	3,000	—	15,000	T135	UL, CSA, TÜV
RTE135-AP	—	—	2,000	10,000	T135	UL, CSA, TÜV
RTE190	500	—	—	10,000	T190	UL, CSA, TÜV
RTE190-2	—	3,000	—	15,000	T190	UL, CSA, TÜV
RTE190-AP	—	—	2,000	10,000	T190	UL, CSA, TÜV
RUE 30V						
RUE090	500	—	—	10,000	U090	UL, CSA, TÜV
RUE090-2	—	3,000	—	15,000	U090	UL, CSA, TÜV
RUE090-AP	—	—	2,000	10,000	U090	UL, CSA, TÜV
RUE110	500	—	—	10,000	U110	UL, CSA, TÜV
RUE110-2	—	3,000	—	15,000	U110	UL, CSA, TÜV
RUE110-AP	—	—	2,000	10,000	U110	UL, CSA, TÜV
RUE135	500	—	—	10,000	U135	UL, CSA, TÜV

Table R6. Packaging and Marking Information for Radial-leaded Devices *continued*

Part Number	Bag Quantity	Tape and Reel Quantity	Ammo Pack Quantity	Standard Package Quantity	Part Marking	Agency Recognition
RUE 30V <i>continued</i>						
RUE135-2	—	3,000	—	15,000	U135	UL, CSA, TÜV
RUE135-AP	—	—	2,000	10,000	U135	UL, CSA, TÜV
RUE160	500	—	—	10,000	U160	UL, CSA, TÜV
RUE160-2	—	3,000	—	15,000	U160	UL, CSA, TÜV
RUE160AP	—	—	2,000	10,000	U160	UL, CSA, TÜV
RUE185	500	—	—	10,000	U185	UL, CSA, TÜV
RUE185-2	—	3,000	—	15,000	U185	UL, CSA, TÜV
RUE185-AP	—	—	2,000	10,000	U185	UL, CSA, TÜV
RUE250	500	—	—	10,000	U250	UL, CSA, TÜV
RUE250-2	—	3,000	—	15,000	U250	UL, CSA, TÜV
RUE250-AP	—	—	2,000	10,000	U250	UL, CSA, TÜV
RUE300	500	—	—	10,000	U300	UL, CSA, TÜV
RUE300-2	—	2,500	—	12,500	U300	UL, CSA, TÜV
RUE300-AP	—	—	1,000	5,000	U300	UL, CSA, TÜV
RUE400	500	—	—	10,000	U400	UL, CSA, TÜV
RUE400-2	—	1,500	—	7,500	U400	UL, CSA, TÜV
RUE400-AP	—	—	1,000	5,000	U400	UL, CSA, TÜV
RUE500	250	—	—	5,000	U500	UL, CSA, TÜV
RUE500-2	—	1,500	—	7,500	U500	UL, CSA, TÜV
RUE500-AP	—	—	1,000	5,000	U500	UL, CSA, TÜV
RUE600	250	—	—	5,000	U600	UL, CSA, TÜV
RUE600-AP	—	—	1,000	5,000	U600	UL, CSA, TÜV
RUE700	250	—	—	5,000	U700	UL, CSA, TÜV
RUE800	250	—	—	5,000	U800	UL, CSA, TÜV
RUE900	250	—	—	5,000	U900	UL, CSA, TÜV
RUSB, RGE 16V						
RUSB090	500	—	—	10,000	R090	UL, CSA, TÜV
RUSB090-2	—	3,000	—	15,000	R090	UL, CSA, TÜV
RUSB090-AP	—	—	2,000	10,000	R090	UL, CSA, TÜV
RUSB110	500	—	—	10,000	R110	UL, CSA, TÜV
RUSB110-2	—	3,000	—	15,000	R110	UL, CSA, TÜV
RUSB110-AP	—	—	2,000	10,000	R110	UL, CSA, TÜV
RUSB135	500	—	—	10,000	R135	UL, CSA, TÜV
RUSB135-2	—	3,000	—	15,000	R135	UL, CSA, TÜV
RUSB135-AP	—	—	2,000	10,000	R135	UL, CSA, TÜV
RUSB155	500	—	—	10,000	R155	UL, CSA, TÜV
RUSB160	500	—	—	10,000	R160	UL, CSA, TÜV
RUSB160-2	—	3,000	—	15,000	R160	UL, CSA, TÜV
RUSB160-AP	—	—	2,000	10,000	R160	UL, CSA, TÜV
RUSB185	500	—	—	10,000	R185	UL, CSA, TÜV
RUSB185-2	—	3,000	—	15,000	R185	UL, CSA, TÜV
RUSB185-AP	—	—	2,000	10,000	R185	UL, CSA, TÜV
RUSB250	500	—	—	10,000	R250	UL, CSA, TÜV
RUSB250-2	—	3,000	—	15,000	R250	UL, CSA, TÜV
RUSB250-AP	—	—	2,000	10,000	R250	UL, CSA, TÜV



Table R6. Packaging and Marking Information for Radial-leaded Devices *continued*

Part Number	Bag Quantity	Tape and Reel Quantity	Ammo Pack Quantity	Standard Package Quantity	Part Marking	Agency Recognition
RGE 16V						
RGE300	500	—	—	10,000	G300	UL, CSA, TÜV
RGE300-2	—	2,500	—	12,500	G300	UL, CSA, TÜV
RGE300-AP	—	—	2,000	10,000	G300	UL, CSA, TÜV
RGE400	500	—	—	10,000	G400	UL, CSA, TÜV
RGE400-2	—	2,500	—	12,500	G400	UL, CSA, TÜV
RGE400-AP	—	—	2,000	10,000	G400	UL, CSA, TÜV
RGE500	500	—	—	10,000	G500	UL, CSA, TÜV
RGE500-2	—	2,000	—	10,000	G500	UL, CSA, TÜV
RGE500-AP	—	—	2,000	10,000	G500	UL, CSA, TÜV
RGE600	500	—	—	10,000	G600	UL, CSA, TÜV
RGE600-2	—	2,000	—	10,000	G600	UL, CSA, TÜV
RGE600-AP	—	—	2,000	10,000	G600	UL, CSA, TÜV
RGE700	500	—	—	10,000	G700	UL, CSA, TÜV
RGE700-2	—	1,500	—	7,500	G700	UL, CSA, TÜV
RGE700-AP	—	—	1,500	7,500	G700	UL, CSA, TÜV
RGE800	500	—	—	10,000	G800	UL, CSA, TÜV
RGE800-2	—	1,000	—	5,000	G800	UL, CSA, TÜV
RGE800-AP	—	—	1,000	5,000	G800	UL, CSA, TÜV
RGE900	500	—	—	10,000	G900	UL, CSA, TÜV
RGE900-2	—	1,000	—	5,000	G900	UL, CSA, TÜV
RGE900-AP	—	—	1,000	5,000	G900	UL, CSA, TÜV
RGE1000	250	—	—	5,000	G1000	UL, CSA, TÜV
RGE1000-2	—	1,000	—	5,000	G1000	UL, CSA, TÜV
RGE1000-AP	—	—	1,000	5,000	G1000	UL, CSA, TÜV
RGE1100	250	—	—	5,000	G1100	UL, CSA, TÜV
RGE1100-2	—	1,000	—	5,000	G1100	UL, CSA, TÜV
RGE1100-AP	—	—	1,000	5,000	G1100	UL, CSA, TÜV
RGE1200	250	—	—	5,000	G1200	UL, CSA, TÜV
RGE1200-2	—	1,000	—	5,000	G1200	UL, CSA, TÜV
RGE1200-AP	—	—	1,000	5,000	G1200	UL, CSA, TÜV
RGE1400	250	—	—	5,000	G1400	UL, CSA, TÜV
RGE1400-2	—	1,000	—	5,000	G1400	UL, CSA, TÜV
RGE1400-AP	—	—	1,000	5,000	G1400	UL, CSA, TÜV
RHE 16V - High Temperature						
RHE070	500	—	—	10,000	H0.7	UL, CSA, TÜV
RHE400	500	—	—	10,000	H4	UL, CSA, TÜV
RHE400-2	—	1,500	—	7,500	H4	UL, CSA, TÜV
RHE400-AP	—	—	1,500	7,500	H4.5	UL, CSA, TÜV
RHE450	500	—	—	10,000	H4.5	UL, CSA, TÜV
RHE450-2	—	1,500	—	7,500	H4.5	UL, CSA, TÜV
RHE450-AP	—	—	1,500	7,500	H4.5	UL, CSA, TÜV
RHE600	500	—	—	10,000	H6	UL, CSA, TÜV
RHE600-2	—	1,500	—	7,500	H6	UL, CSA, TÜV
RHE600-AP	—	—	1,500	7,500	H6	UL, CSA, TÜV
RHE650	500	—	—	10,000	H6.5	UL, CSA, TÜV
RHE750	500	—	—	10,000	H7.5	UL, CSA, TÜV
RHE750-2	—	1,000	—	5,000	H7.5	UL, CSA, TÜV
RHE750-AP	—	—	1,000	5,000	H7.5	UL, CSA, TÜV
RHE1000	250	—	—	5,000	H10	UL, CSA, TÜV
RHE1000-2	—	1,000	—	5,000	H10	UL, CSA, TÜV
RHE1000-AP	—	—	1,000	5,000	H10	UL, CSA, TÜV

Table R6. Packaging and Marking Information for Radial-led Devices *continued*

Part Number	Bag Quantity	Tape and Reel Quantity	Ammo Pack Quantity	Standard Package Quantity	Part Marking	Agency Recognition
RHE 16V						
RHE1300	250	—	—	5,000	H13	UL, CSA, TÜV
RHE1300-2	—	1,000	—	5,000	H13	UL, CSA, TÜV
RHE1300-AP	—	—	1,000	5,000	H13	UL, CSA, TÜV
RHE1500	250	—	—	5,000	H15	UL, CSA, TÜV
RHE1500-2	—	1,000	—	5,000	H15	UL, CSA, TÜV
RHE1500-AP	—	—	1,000	5,000	H15	UL, CSA, TÜV
RUSB 6V						
RUSB075	500	—	—	10,000	R075	UL, CSA, TÜV
RUSB075-2	—	3,000	—	15,000	R075	UL, CSA, TÜV
RUSB075-AP	—	—	2,500	12,500	R075	UL, CSA, TÜV
RUSB120	500	—	—	10,000	R120	UL, CSA, TÜV
RUSB120-2	—	3,000	—	15,000	R120	UL, CSA, TÜV
RUSB120-AP	—	—	2,000	10,000	R120	UL, CSA, TÜV
RUSB155	500	—	—	10,000	R155	UL, CSA, TÜV

Part Numbering System

Table R7. Tape and Reel Specifications for Radial-leaded Devices

RXE and BBR devices are available in tape and reel packaging per EIA468–B/IEC60286–2 standards. See Figures R22 and R23 for details.

Description	EIA Mark	Dimension (mm)	Tolerance
Carrier tape width	W	18	-0.5/+1.0
Hold-down tape width	W_4	11	Minimum
Top distance between tape edges	W_6	3	Maximum
Sprocket hole position	W_5	9	-0.5/+0.75
Sprocket hole diameter	D_0	4	± 0.2
Abscissa to plane (straight lead) RXE110 to RXE375	H	18.5	± 2.5
Abscissa to plane (kinked lead) RXE010 to RXE090, BBR550, BBR750	H_0	16.0	± 0.5
Abscissa to top RXE010 to RXE090, BBR550, BBR750	H_1	32.2	Maximum
Abscissa to top RXE110 to RXE375*	H_1	47.5	Maximum
Overall width with lead protrusion RXE010 to RXE090, BBR550, BBR750	C_1	43.2	Maximum
Overall width with lead protrusion RXE110 to RXE375*	C_1	58	Maximum
Overall width without lead protrusion RXE010 to RXE090, BBR550, BBR750	C_2	42.5	Maximum
Overall width without lead protrusion RXE110 to RXE375*	C_2	57	Maximum
Lead protrusion	L_1	1.0	Maximum
Protrusion of cut-out	L	11.0	Maximum
Protrusion beyond hold-down tape	l_2	Not specified	—
Sprocket hole pitch	P_0	12.7	± 0.3
Device pitch RXE010 to RXE090, BBR550, BBR750	—	12.7	± 0.3
Device pitch RXE110 to RXE375	—	25.4	± 0.61
Pitch tolerance	—	20 consecutive	± 1
Tape thickness	t	0.9	Maximum
Overall tape and lead thickness RXE010 to RXE090	t_1	1.5	Maximum
Overall tape and lead thickness RXE110 to RXE375, BBR550, BBR750*	t_1	2.3	Maximum
Splice sprocket hole alignment	—	0	± 0.3
Body lateral deviation	Δh	0	± 1.0
Body tape plane deviation	Δp	0	± 1.3
Ordinate to adjacent component lead RXE010 to RXE090, BBR550, BBR750	P_1	3.81	± 0.7
Ordinate to adjacent component lead RXE110 to RXE375	P_1	7.62	± 0.7
Lead spacing* RXE010 to RXE185, BBR550, BBR750	F	5.08	+0.75/-0.5
Lead spacing* RXE250 to RXE375	F	10.2	+0.75/-0.5
Reel width RXE010 to RXE090	w_2	56.0	Maximum
Reel width* RXE110 to RXE375*	w_2	63.5	Maximum
Reel diameter	a	370.0	Maximum
Space between flanges less device	w_1	4.75	± 3.25
Arbor hold diameter	c	26.0	± 12.0
Core diameter*	n	91.0	Maximum
Box	—	64/372/362	Maximum
Consecutive missing places	—	None	—
Empty places per reel	—	0.1%	Maximum

*Differs from EIA specification.

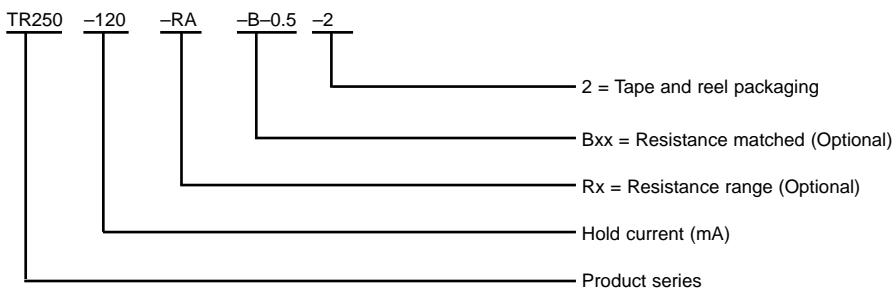
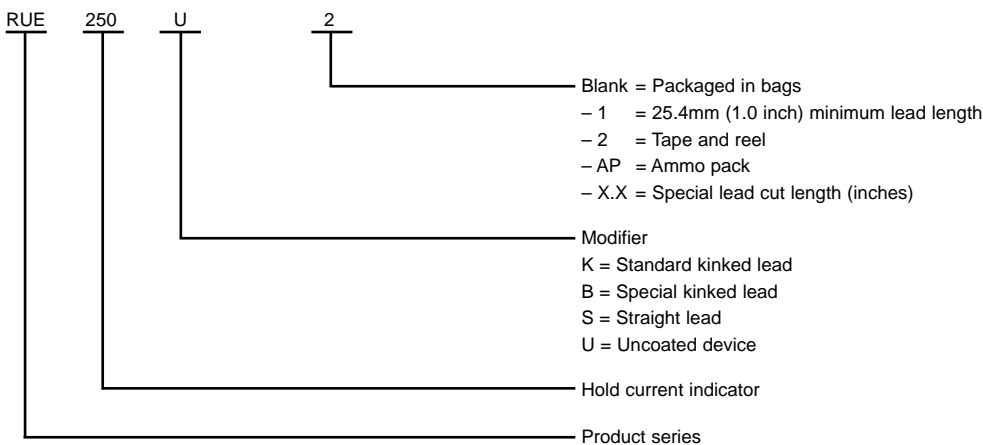
Table R7. Tape and Reel Specifications for Radial-leded Devices *continued*

RUE, RTE and RUSB devices are available in tape and reel packaging per EIA468-B/IEC60286-2 standards. See Figures R22 and R23 for details.

Description	EIA Mark	Dimension (mm)	Tolerance
Carrier tape width	W	18	-0.5/+1.0
Hold-down tape width	W ₄	11	Minimum
Top distance between tape edges	W ₆	3	Maximum
Sprocket hole position	W ₅	9	-0.5/+0.75
Sprocket hole diameter	D ₀	4	± 0.2
Abscissa to plane (straight lead)* RUE300 to RUE900	H	18.5	± 2.5
Abscissa to plane (kinked lead) RUSB075 to RUSB250, RUE090 to RUE250, RTE120 to RTE190	H ₀	16.0	± 0.5
Abscissa to top RUSB075 to RUSB250, RUE090 to RUE300, RTE120 to RTE190	H ₁	32.2	Maximum
Abscissa to top RUE400 to RUE900*	H ₁	45.0	Maximum
Overall width w/lead protrusion RUSB075 to RUSB250, RUE090 to RUE300, RTE120 to RTE190	C ₁	43.2	Maximum
Overall width w/ lead protrusion RUE400 to RUE900	C ₁	56	Maximum
Overall width w/o lead protrusion RUSB075 to RUSB250, RUE090 to RUE300, RTE120 to RTE190	C ₂	42.5	Maximum
Overall width w/o lead protrusion RUE400 to RUE900	C ₂	56	Maximum
Lead protrusion	L ₁	1.0	Maximum
Protrusion of cut-out	L	11	Maximum
Protrusion beyond hold-down tape	I ₂	Not specified	—
Sprocket hole pitch	P ₀	12.7	± 0.3
Device pitch RUSB075 to RUSB250, RUE090 to RUE300, RTE120 to RTE190	—	12.7	± 0.3
Device pitch RUE400 to RUE900	—	25.4	± 0.6
Pitch tolerance	—	20 consecutive	± 1
Tape thickness	t	0.9	Maximum
Overall tape and lead thickness RUSB075 to RUSB250, RUE090 to RUE250, RTE120 to RTE190	t ₁	1.5	Maximum
Overall tape and lead thickness RUE300 to RUE900*	t ₁	2.3	Maximum
Splice sprocket hole alignment	—	0	± 0.3
Body lateral deviation	Δh	0	± 1.0
Body tape plane deviation	Δp	0	± 1.3
Ordinate to adjacent component lead RUSB075 to RUSB250, RUE090 to RUE300, RTE120 to RTE190	P ₁	3.81	± 0.7
Ordinate to adjacent component lead RUE400 to RUE900	P ₁	7.62	± 0.7
Lead spacing* RUSB075 to RUSB250, RUE090 to RUE400, RTE120 to RTE190	F	5.08	+0.75/-0.5
Lead spacing* RUE500 to RUE900	F	10.2	+0.75/-0.5
Reel width RUE090 to RUE400, RUSB075 to RUSB250, RTE120 to RTE190	w ₂	56.0	Maximum
Reel width RUE500 to RUE900*	w ₂	63.5	Maximum
Reel diameter	a	370.0	Maximum
Space between flanges less device	w ₁	4.75	± 3.25
Arbor hold diameter	c	26.0	± 12.0
Core diameter*	n	91.0	Maximum
Box	—	64/372/362	Maximum
Consecutive missing places	—	None	—
Empty places per reel	—	0.1%	Maximum

*Differs from EIA specification.

Table R7. Tape and Reel Specifications for Radial-led Devices *continued*

RGE and RHE devices are available in tape and reel packaging per EIA468-B/IEC60286-2 standards. See Figures R22 and R23 for details.

Dimension Description	EIA Mark	Dimension (mm)	Tolerance
Carrier tape width	W	18	-0.5/+1.0
Hold-down tape width	W ₄	11	Minimum
Top distance between tape edges	W ₆	3	Maximum
Sprocket hole position	W ₅	9	-0.5/+0.75
Sprocket hole diameter	D ₀	4	± 0.2
Abscissa to plane (straight lead) RGE300 to RGE1400	H	18.5	± 2.5
Abscissa to plane (kinked lead) RHE400 to RHE1500	H ₀	16.0	± 0.5
Abscissa to top RGE300 to RGE600, RHE400, RHE450	H ₁	32.2	Maximum
Abscissa to top* RGE700 to RGE1400, RHE600 to RHE1500	H ₁	45.0	Maximum
Overall width w/lead protrusion RGE300 to RGE600, RHE400, RHE450	C ₁	43.2	Maximum
Overall width w/lead protrusion RGE700 to RGE1400, RHE600 to RHE1500	C ₁	55	Maximum
Overall width w/o lead protrusion RGE300 to RGE600, RHE400, RHE450	C ₂	42.5	Maximum
Overall width w/o lead protrusion RGE700 to RGE1400, RHE600 to RHE1500	C ₂	54	Maximum
Lead protrusion	L ₁	1.0	Maximum
Protrusion of cut-out	L	11	Maximum
Protrusion beyond hold-down tape	I ₂	Not specified	—
Sprocket hole pitch	P ₀	12.7	± 0.3
Device pitch RGE300 to RGE700, RHE400 to RHE600	—	25.4	± 0.61
Device pitch RGE800 to RGE1400, RHE650 to RHE1500	—	25.4	± 0.6
Pitch tolerance	—	20 consecutive	± 1
Tape thickness	t	0.9	Maximum
Overall tape and lead thickness* RGE300 to RGE1100, RHE400 to RHE1000	t ₁	2.0	Maximum
Overall tape and lead thickness* RGE1200 to RGE1400, RHE1300, RHE1500*	t ₁	2.3	Maximum
Splice sprocket hole alignment	—	0	± 0.3
Body lateral deviation	Δh	0	± 1.0
Body tape plane deviation	Δp	0	± 1.3
Ordinate to adjacent component lead RGE300 to RGE1100, RHE400 to RHE750	P ₁	3.81	± 0.7
Ordinate to adjacent component lead RGE1200 to RGE1400, RHE1000 to RHE1500	P ₁	7.62	± 0.7
Lead spacing* RGE300 to RGE1100, RHE400 to RHE750	F	5.08	+0.75 /-0.5
Lead spacing* RGE1200 to RGE1400, RHE1000 to RHE1500	F	10.2	+ 0.75/-0.5
Reel width RGE300 to RGE600, RHE400 & RHE450	w ₂	56.0	Maximum
Reel width* RGE600 to RGE1400 & RHE600 to RHE1500	w ₂	63.5	Maximum
Reel diameter	a	370.0	Maximum
Space between flanges less device*	w ₁	4.75	± 3.25
Arbor hold diameter	c	26.0	± 12.0
Core diameter*	n	91.0	Maximum
Box	—	64/372/362	Maximum
Consecutive missing places	—	None	—
Empty places per reel	—	0.1%	Maximum

*Differs from EIA specification.

4

Figure R22. EIA Referenced Taped Component Dimensions for Radial-leaded Devices

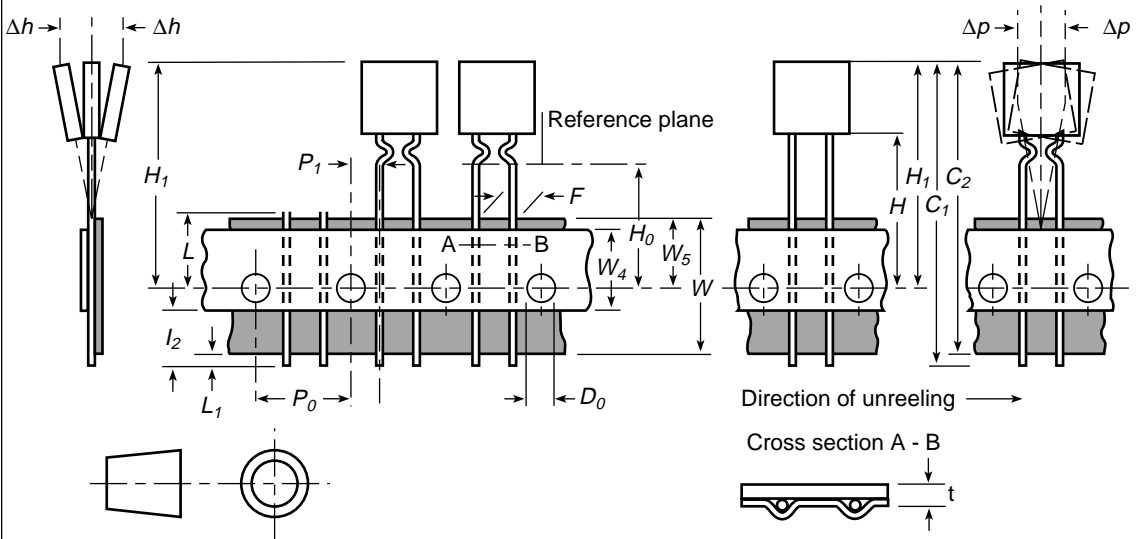

4

Figure R23. EIA Referenced Reel Dimensions for Radial-leaded Devices

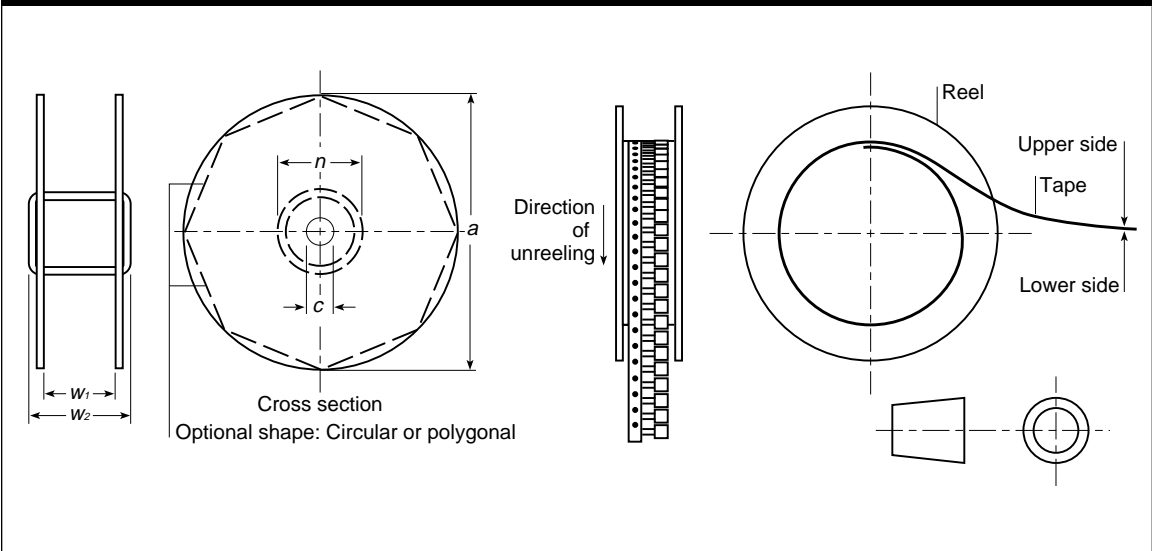

Latest Information

- Please visit us at www.circuitprotection.com or contact your local representative for the latest information.
- The information in this Databook contains some preliminary information. Raychem Circuit Protection, a division of Tyco Electronics, reserves the right to change any of the specifications without notice. In addition, Tyco Electronics reserves the right to make changes—without notification to Buyer—to materials or processing that do not affect compliance with any applicable specification.



WARNING:

- Operation beyond the maximum ratings or improper use may result in device damage and possible electrical arcing and flame.
- The devices are intended for protection against occasional overcurrent or overtemperature fault conditions and should not be used when repeated fault conditions or prolonged trip events are anticipated.
- Contamination of the PPTC material with certain silicon based oils or some aggressive solvents can adversely impact the performance of the devices.
- Device performance can be impacted negatively if devices are handled in a manner inconsistent with recommended electronic, thermal, and mechanical procedures for electronic components.
- Operation in circuits with a large inductance can generate a circuit voltage ($L \frac{di}{dt}$) above the rated voltage of the PolySwitch resettable device.

欢迎索取免费详细资料、设计选型指南和光盘、样品；产品繁多未能尽录，欢迎来电查询。

[中国传感器科技信息网：HTTP://WWW.SENSOR-IC.COM/](http://WWW.SENSOR-IC.COM/)

[工控安防网：HTTP://WWW.PC-PS.NET/](http://WWW.PC-PS.NET/)

[消费电子专用电路网：HTTP://WWW.SUNSTARE.COM/](http://WWW.SUNSTARE.COM/)

E-MAIL：xjr5@163.com szss20@163.com

MSN：suns8888@hotmail.com

QQ：195847376

地址：深圳市福田区福华路福庆街鸿图大厦 1602 室

电话：0755-83376549 83376489 83387030 83387016

传真：0755-83376182 83338339 邮编：518033 手机：(0)13902971329

深圳展销部：深圳华强北路赛格电子市场 2583 号 TEL/FAX：
0755-83665529 25059422

北京分公司：北京海淀区知春路 132 号中发电子大厦 3097 号

TEL：010-81159046 82615020 13501189838 FAX：010-82613476

上海分公司：上海市北京东路 668 号上海赛格电子市场 2B35 号

TEL：021-28311762 56703037 13701955389 FAX：021-56703037

西安分公司：西安高新开发区 20 所(中国电子科技集团导航技术研究所)
西安劳动南路 88 号电子商城二楼 D23 号

TEL：029-81022619 13072977981 FAX:029-88789382

成都：TEL:(0)13717066236

技术支持：0755-83394033 13501568376

SUNSTAR商斯达实业集团是集研发、生产、工程、销售、代理经销、技术咨询、信息服务等为一体的高科技企业，是专业高科技电子产品生产厂家，是具有10多年历史的专业电子元器件供应商，是中国最早和最大的仓储式连锁规模经营大型综合电子零部件代理分销商之一，是一家专业代理和分销世界各大品牌IC芯片和电子元器件的连锁经营综合性国际公司。在香港、北京、深圳、上海、西安、成都等全国主要电子市场设有直属分公司和产品展示展销窗口门市部专卖店及代理分销商，已在全国范围内建成强大统一的供货和代理分销网络。我们专业代理经销、开发生产电子元器件、集成电路、传感器、微波光电元器件、工控机/DOC/DOM电子盘、专用电路、单片机开发、MCU/DSP/ARM/FPGA软件硬件、二极管、三极管、模块等，是您可靠的一站式现货配套供应商、方案提供商、部件功能模块开发配套商。专业以现代信息产业（计算机、通讯及传感器）三大支柱之一的传感器为主营业务，专业经营各类传感器的代理、销售生产、网络信息、科技图书资料及配套产品设计、工程开发。我们的专业网站——中国传感器科技信息网（全球传感器数据库）www.SENSOR-IC.COM 服务于全球高科技生产商及贸易商，为企业科技产品开发提供技术交流平台。欢迎各厂商互通有无、交换信息、交换链接、发布寻求代理信息。欢迎国外高科技传感器、变送器、执行器、自动控制产品厂商介绍产品到中国，共同开拓市场。本网站是关于各种传感器-变送器-仪器仪表及工业自动化大型专业网站，深入到工业控制、系统工程计 测量、自动化、安防报警、消费电子等众多领域，把最新的传感器-变送器-仪器仪表买卖信息，最新技术供求，最新采购商，行业动态，发展方向，最新的技术应用和市场资讯及时的传递给广大科技开发、科学研究、产品设计人员。本网站已成功为石油、化工、电力、医药、生物、航空、航天、国防、能源、冶金、电子、工业、农业、交通、汽车、矿山、煤炭、纺织、信息、通信、IT、安防、环保、印刷、科研、气象、仪器仪表等领域从事科学研究、产品设计、开发、生产制造的科技人员、管理人员、和采购人员提供满意服务。我们公司专业生产、代理、经销、销售各种传感器、变送器、敏感元器件、开关、执行器、仪器仪表、自动化控制系统：专门从事设计、生产、销售各种传感器、变送器、各种测控仪表、热工仪表、现场控制器、计算机控制系统、数据采集系统、各类环境监控系统、专用控制系统应用软件以及嵌入式系统开发及应用等工作。如热敏电阻、压敏电阻、温度传感器、温度变送器、湿度传感器、湿度变送器、气体传感器、气体变送器、压力传感器、压力变送、称重传感器、物（液）位传感器、物（液）位变送器、流量传感器、流量变送器、电流（压）传感器、溶氧传感器、霍尔传感器、图像传感器、超声波传感器、位移传感器、速度传感器、加速度传感器、扭距传感器、红外传感器、紫外传感器、火焰传感器、激光传感器、振动传感器、轴角传感器、光电传感器、接近传感器、干簧管传感器、继电器传感器、微型电泵、磁敏（阻）传感器、压力开关、接近开关、光电开关、色标传感器、光纤传感器、齿轮测速传感器、时间继电器、计数器、计米器、温控仪、固态继电器、调压模块、电磁铁、电压表、电流表等特殊传感器。同时承接传感器应用电路、产品设计和自动化工程项目。

更多产品请看本公司产品专用销售网站：

商斯达中国传感器科技信息网：<http://www.sensor-ic.com/>

商斯达工控安防网：<http://www.pc-ps.net/>

商斯达电子元器件网：<http://www.sunstare.com/>

商斯达微波光电产品网：[HTTP://www.rfoe.net/](http://www.rfoe.net/)

商斯达消费电子产品网：<http://www.icasic.com/>

商斯达军工产品网：<http://www.junpinic.com/>

商斯达实业科技产品网：<http://www.sunstars.cn/> 传感器销售热线：

地址：深圳市福田区福华路福庆街鸿图大厦1602室

电话：0755-83607652 83376489 83376549 83370250 83370251 82500323

传真：0755-83376182 (0) 13902971329 MSN: SUNS888@hotmail.com

邮编：518033 E-mail: szss20@163.com QQ: 195847376

深圳赛格展销部：深圳华强北路赛格电子市场2583号 电话：0755-83665529 25059422

技术支持：0755-83394033 13501568376

欢迎索取免费详细资料、设计指南和光盘；产品凡多，未能尽录，欢迎来电查询。

北京分公司：北京海淀区知春路132号中发电子大厦3097号

TEL: 010-81159046 82615020 13501189838 FAX: 010-62543996

上海分公司：上海市北京东路668号上海赛格电子市场D125号

TEL: 021-28311762 56703037 13701955389 FAX: 021-56703037

西安分公司：西安高新开发区20所(中国电子科技集团导航技术研究所)

西安劳动南路88号电子商城二楼D23号

TEL: 029-81022619 13072977981 FAX: 029-88789382