

**GaAs pHEMT MMIC MODULATOR DRIVER AMPLIFIER, DC - 20 GHz**

**Typical Applications**

The HMC465 wideband driver is ideal for:

- OC192 LN/MZ Modulator Driver
- Telecom Infrastructure
- Test Instrumentation
- Military & Space

**Functional Diagram**

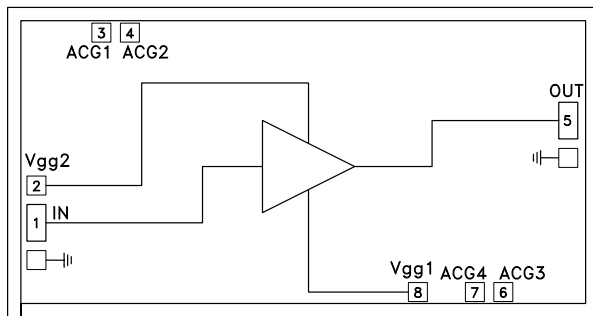

**Features**

- Gain: 17 dB
- Output Voltage to 10 Vp-p
- Saturated Output Power: +24 dBm
- Supply Voltage: +8V @160mA
- 50 Ohm Matched Input/Output
- Die Size: 3.12 x 1.63 x 0.1 mm

**General Description**

The HMC465 is a GaAs MMIC pHEMT Distributed Driver Amplifier die which operates between DC and 20 GHz. The amplifier provides 17 dB of gain, 2.5 dB noise figure and +24 dBm of saturated output power while requiring only 160 mA from a +8V supply. Gain flatness is excellent at  $\pm 0.25$  dB as well as  $\pm 1$  deg deviation from linear phase from DC - 10 GHz making the HMC465 ideal for OC192 fiber optic LN/MZ modulator driver amplifier as well as test equipment applications. The HMC465 amplifier I/Os are internally matched to 50 Ohms for easy integration into Multi-Chip-Modules (MCMs). All data is measured with the chip in a 50 Ohm test fixture connected via 0.025 mm (1 mil) diameter wire bonds of minimal length 0.31mm (12 mils).

**Electrical Specifications,  $T_A = +25^\circ\text{C}$ ,  $V_{dd} = 8\text{V}$ ,  $V_{gg2} = 1.5\text{V}$ ,  $I_{dd} = 160\text{mA}^*$**

Parameter	Min.	Typ.	Max.	Min.	Typ.	Max.	Min.	Typ.	Max.	Units
Frequency Range	DC - 6			6 - 12			12 - 20			GHz
Gain	15	18		15	17		13	16.5		dB
Gain Flatness		$\pm 0.5$			$\pm 0.25$			$\pm 0.5$		dB
Gain Variation Over Temperature		0.015	0.025		0.015	0.025		0.02	0.03	dB/°C
Noise Figure		3	5		2.5	3.5		3	4.5	dB
Input Return Loss		18			20			16		dB
Output Return Loss		18			17			17		dB
Output Power for 1 dB Compression (P1dB)	19.5	22.5		19	22		17	20		dBm
Saturated Output Power (Psat)		24			24			22		dBm
Output Third Order Intercept (IP3)		33			30			26		dBm
Saturated Output Voltage		10			10			8		Vp-p
Group Delay Variation		$\pm 3$			$\pm 3$			$\pm 3$		ps
Supply Current (Idd) (Vdd = 8V, Vgg1 = -0.6V Typ.)		160			160			160		mA

\* Adjust Vgg1 between -2 to 0V to achieve Idd = 160mA typical.

**GaAs pHEMT MMIC MODULATOR  
 DRIVER AMPLIFIER, DC - 20 GHz**

**Gain & Return Loss**

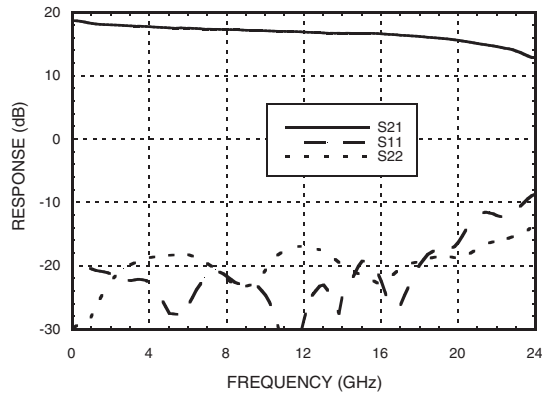

**Gain vs. Temperature**

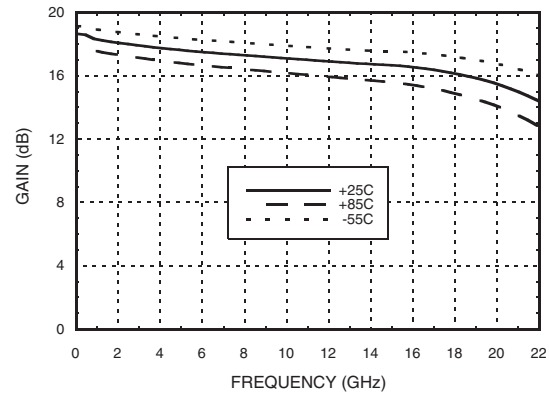

**Input Return Loss vs. Temperature**

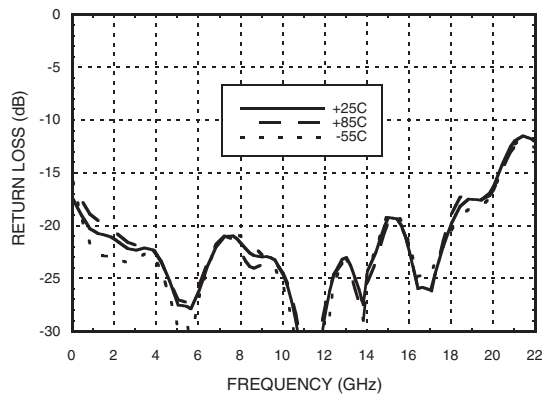

**Output Return Loss vs. Temperature**

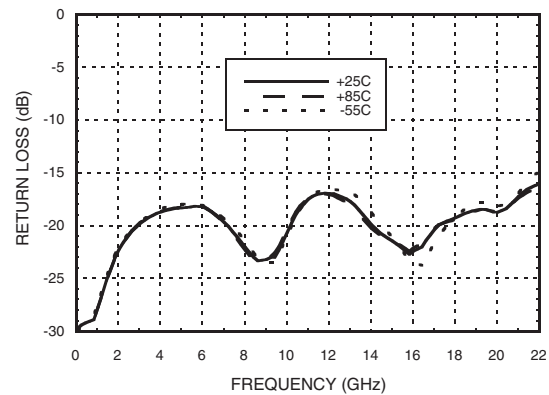

**Low Frequency Gain & Return Loss**

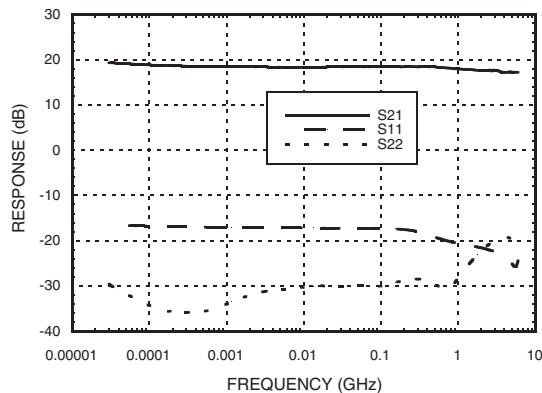

**Noise Figure vs. Temperature**

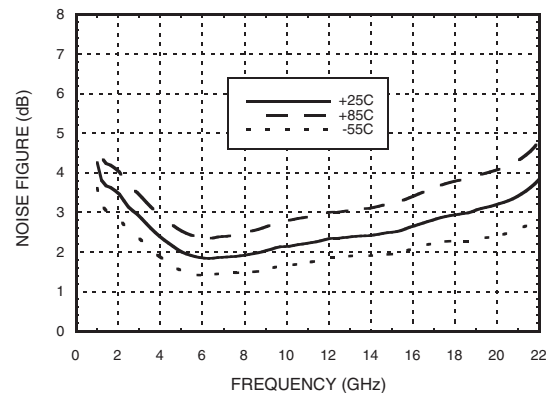

## GaAs pHEMT MMIC MODULATOR DRIVER AMPLIFIER, DC - 20 GHz

2

AMPLIFIERS - DRIVER & GAIN BLOCK - CHIP

**Output P1dB vs. Temperature**

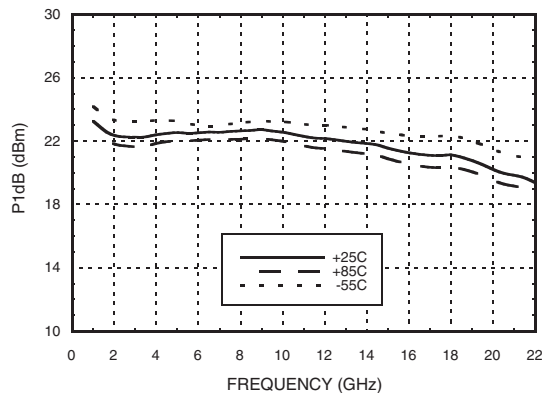

**Psat vs. Temperature**

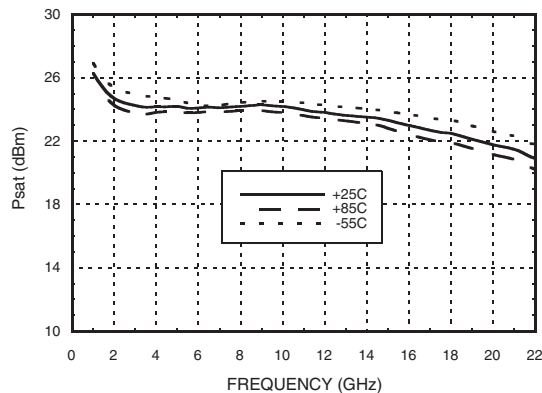

**Output IP3 vs. Temperature**

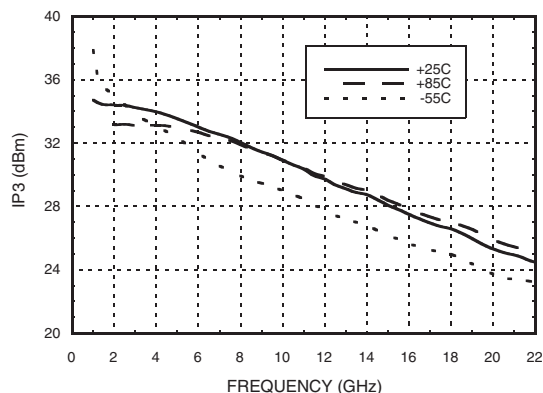

**Gain, Power & Output IP3 vs. Supply Voltage @ 10 GHz, I<sub>dd</sub>= 160mA**

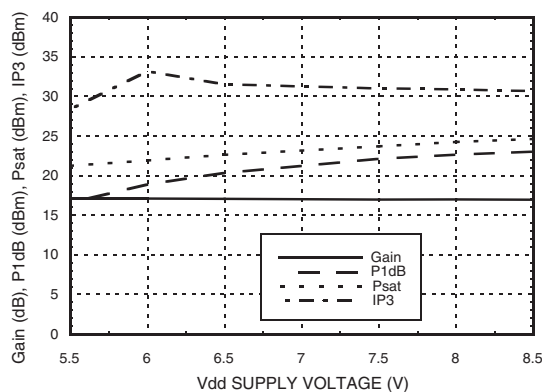

**Group Delay**

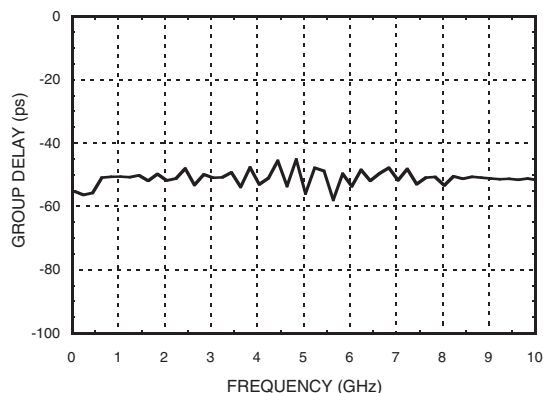

**Deviation from Linear Phase**

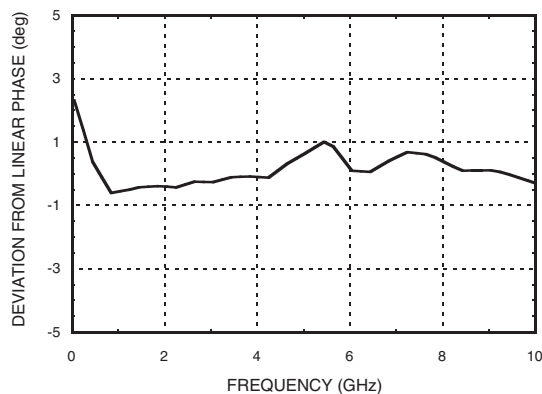

## GaAs pHEMT MMIC MODULATOR DRIVER AMPLIFIER, DC - 20 GHz

### Absolute Maximum Ratings

Drain Bias Voltage (Vdd)	+9V
Gate Bias Voltage (Vgg1)	-2 to 0V
Gate Bias Voltage (Vgg2)	(Vdd -8) V to Vdd
RF Input Power (RFIN)(Vdd = +8V)	+23 dBm
Channel Temperature	175 °C
Continuous Pdiss (T = 85 °C) (derate 24 mW/°C above 85 °C)	2.17 W
Thermal Resistance (channel to die bottom)	41.5 °C/W
Storage Temperature	-65 to +150 °C
Operating Temperature	-55 to +85 °C

### Typical Supply Current vs. Vdd

Vdd (V)	Idd (mA)
+7.5	161
+8.0	160
+8.5	159



ELECTROSTATIC SENSITIVE DEVICE  
OBSERVE HANDLING PRECAUTIONS

### Outline Drawing

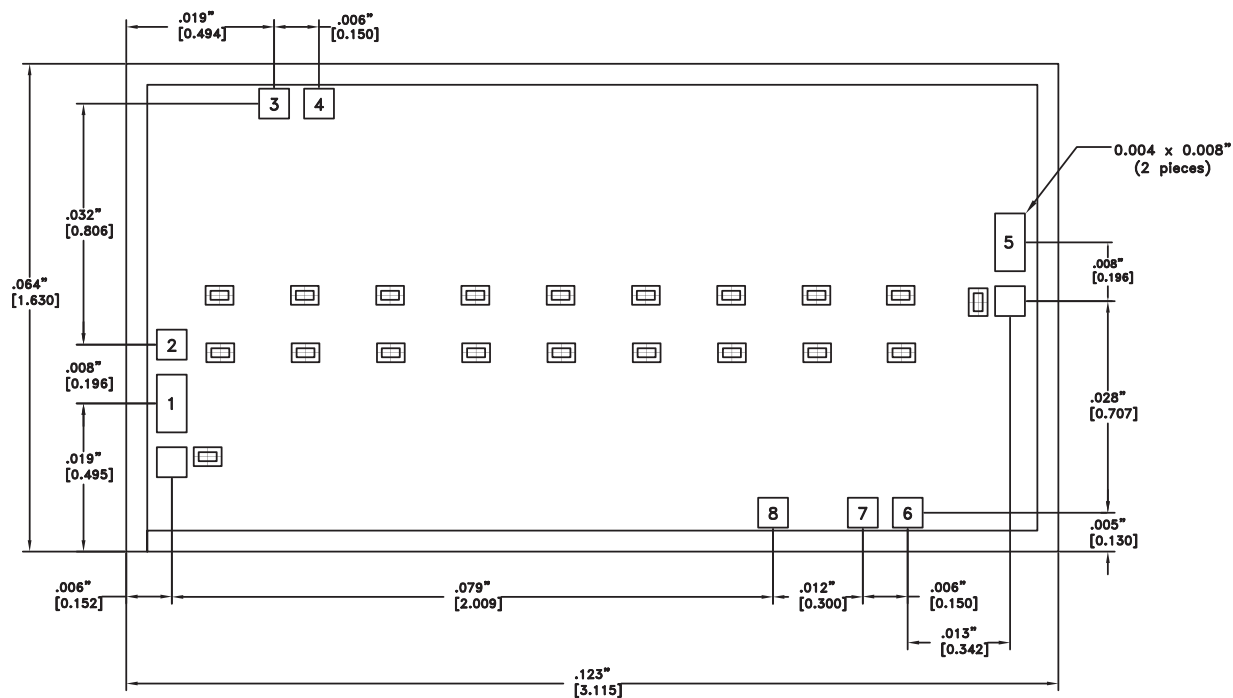

### Die Packaging Information [1]

Standard	Alternate
GP-1 (Gel Pack)	[2]

[1] Refer to the "Packaging Information" section for die packaging dimensions.

[2] For alternate packaging information contact Hittite Microwave Corporation.

#### NOTES:

1. ALL DIMENSIONS IN INCHES [MILLIMETERS]
2. NO CONNECTION REQUIRED FOR UNLABELED BOND PADS
3. DIE THICKNESS IS 0.004 (0.100)
4. TYPICAL BOND PAD IS 0.004 (0.100) SQUARE
5. BACKSIDE METALLIZATION: GOLD
6. BACKSIDE METAL IS GROUND
7. BOND PAD METALIZATION: GOLD



For price, delivery and to place orders: Hittite Microwave Corporation, 20 Alpha Road, Chelmsford, MA 01824

SUNSTAR 射频通信 <http://www.hittite.com> TEL:0755-83396822 FAX:0755-83376182 E-MAIL: szss20@163.com

Application Support: Phone: 978-250-3343 or [apps@hittite.com](mailto:apps@hittite.com)

**GaAs pHEMT MMIC MODULATOR  
DRIVER AMPLIFIER, DC - 20 GHz**

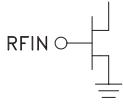
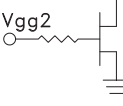
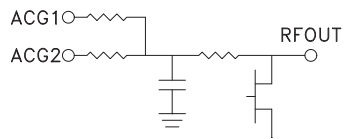
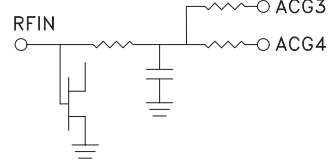
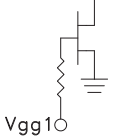
**Pad Descriptions**

Pad Number	Function	Description	Interface Schematic
1	RFIN	This pad is DC coupled and matched to 50 Ohms.	
2	Vgg2	Gate Control 2 for amplifier. +1.5V should be applied to Vgg2 for nominal operation.	
3	ACG1	Low frequency termination. Attach bypass capacitor per application circuit herein.	
4	ACG2		
5	RFOUT & Vdd	RF output for amplifier. Connect the DC bias (Vdd) network to provide drain current (Idd). See application circuit herein.	
6	ACG3	Low frequency termination. Attach bypass capacitor per application circuit herein.	
7	ACG4		
8	Vgg1	Gate Control 1 for amplifier.	
Die Bottom	GND	Die bottom must be connected to RF/DC ground.	

**GaAs pHEMT MMIC MODULATOR  
DRIVER AMPLIFIER, DC - 20 GHz**

**Assembly Diagram**

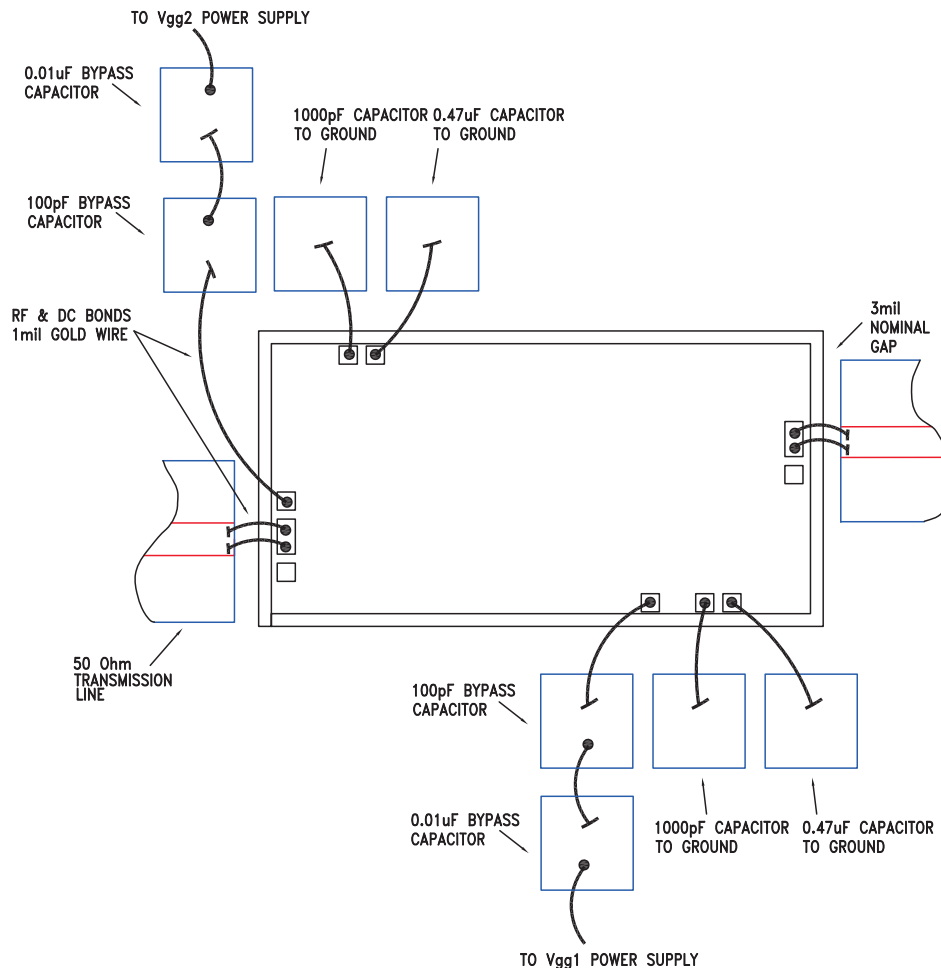

**Application Circuit**

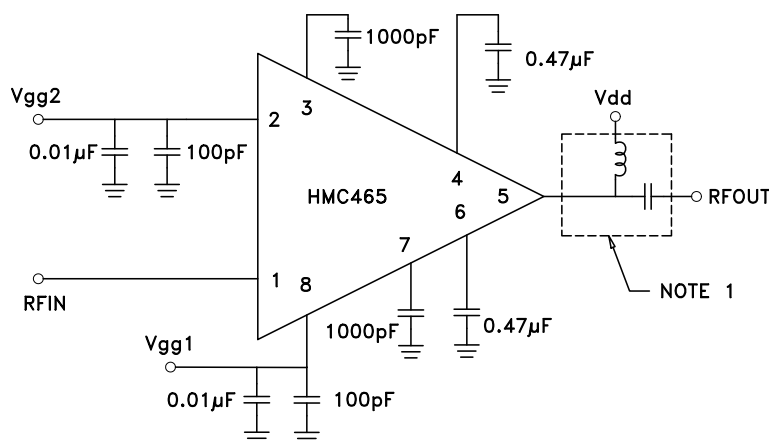

NOTE 1: Drain Bias (Vdd) must be applied through a broadband bias tee or external bias network.

## GaAs pHEMT MMIC MODULATOR DRIVER AMPLIFIER, DC - 20 GHz

### Device Operation

These devices are susceptible to damage from Electrostatic Discharge. Proper precautions should be observed during handling, assembly and test.

The input to this device should be AC-coupled. To provide the typical 8Vp-p output voltage swing, a 1.2Vp-p AC-coupled input voltage swing is required.

### Device Power Up Instructions

1. Ground the device
2. Set Vgg1 to -2V (no drain current)
3. Set Vgg2 to +1.5V (no drain current)
4. Set Vdd to +8V (no drain current)
5. Adjust Vgg1 for Idd = 160mA (Vgg1 may be varied between -2V and 0V to set Idd to 160mA)
6. Apply RF signal to input.

### Device Power Down Instructions

1. Remove RF signal from input
2. Remove Vdd
3. Remove Vgg2
4. Remove Vgg1

**GaAs pHEMT MMIC MODULATOR  
DRIVER AMPLIFIER, DC - 20 GHz**

**Mounting & Bonding Techniques for Millimeterwave GaAs MMICs**

The die should be attached directly to the ground plane eutectically or with conductive epoxy (see HMC general Handling, Mounting, Bonding Note).

50 Ohm Microstrip transmission lines on 0.127mm (5 mil) thick alumina thin film substrates are recommended for bringing RF to and from the chip (Figure 1). If 0.254mm (10 mil) thick alumina thin film substrates must be used, the die should be raised 0.150mm (6 mils) so that the surface of the die is coplanar with the surface of the substrate. One way to accomplish this is to attach the 0.102mm (4 mil) thick die to a 0.150mm (6 mil) thick molybdenum heat spreader (moly-tab) which is then attached to the ground plane (Figure 2).

Microstrip substrates should be brought as close to the die as possible in order to minimize bond wire length. Typical die-to-substrate spacing is 0.076mm to 0.152 mm (3 to 6 mils).

**Handling Precautions**

Follow these precautions to avoid permanent damage.

**Storage:** All bare die are placed in either Waffle or Gel based ESD protective containers, and then sealed in an ESD protective bag for shipment. Once the sealed ESD protective bag has been opened, all die should be stored in a dry nitrogen environment.

**Cleanliness:** Handle the chips in a clean environment. DO NOT attempt to clean the chip using liquid cleaning systems.

**Static Sensitivity:** Follow ESD precautions to protect against ESD strikes.

**Transients:** Suppress instrument and bias supply transients while bias is applied. Use shielded signal and bias cables to minimize inductive pick-up.

**General Handling:** Handle the chip along the edges with a vacuum collet or with a sharp pair of bent tweezers. The surface of the chip has fragile air bridges and should not be touched with vacuum collet, tweezers, or fingers.

**Mounting**

The chip is back-metallized and can be die mounted with AuSn eutectic preforms or with electrically conductive epoxy. The mounting surface should be clean and flat.

**Eutectic Die Attach:** A 80/20 gold tin preform is recommended with a work surface temperature of 255 deg. C and a tool temperature of 265 deg. C. When hot 90/10 nitrogen/hydrogen gas is applied, tool tip temperature should be 290 deg. C. DO NOT expose the chip to a temperature greater than 320 deg. C for more than 20 seconds. No more than 3 seconds of scrubbing should be required for attachment.

**Epoxy Die Attach:** Apply a minimum amount of epoxy to the mounting surface so that a thin epoxy fillet is observed around the perimeter of the chip once it is placed into position. Cure epoxy per the manufacturer's schedule.

**Wire Bonding**

Ball or wedge bond with 0.025mm (1 mil) diameter pure gold wire. Thermosonic wirebonding with a nominal stage temperature of 150 deg. C and a ball bonding force of 40 to 50 grams or wedge bonding force of 18 to 22 grams is recommended. Use the minimum level of ultrasonic energy to achieve reliable wirebonds. Wirebonds should be started on the chip and terminated on the package or substrate. All bonds should be as short as possible <0.31mm (12 mils).

