



HMC775LC5

GaAs MMIC I/Q MIXER W/ LO AMPLIFIER, 10 - 16 GHz

Typical Applications

The HMC775LC5 is ideal for:

- Point-to-Point and Point-to-Multi-Point Radio
- Digital Radio
- VSAT
- Military & Space

Features

- Wide IF Bandwidth: DC - 3.5 GHz
- Image Rejection: 25 dB
- LO to RF Isolation: 45 dB
- High Input IP3: +25 dBm
- Upconversion & Downconversion Applications
- 0 dBm LO Drive
- 32 Lead 5x5 mm SMT Package: 25mm²

Functional Diagram

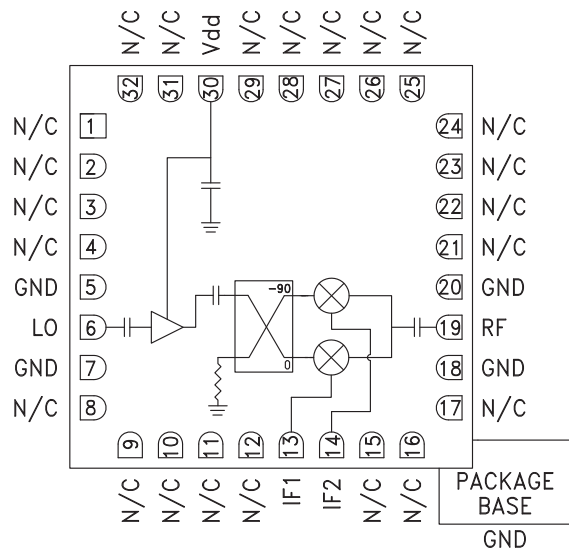

General Description

The HMC775LC5 is a compact I/Q MMIC mixer in a leadless ceramic SMT package, which can be used as either an Image Reject Mixer or a Single Sideband Upconverter. The mixer utilizes two standard Hittite double balanced mixer cells and a 90 degree hybrid fabricated in a GaAs MESFET process. A low frequency quadrature hybrid was used to produce a 1 GHz USB IF output. This product is a much smaller alternative to hybrid style Image Reject Mixers and Single Sideband Upconverter assemblies. The HMC775LC5 eliminates the need for wire bonding and allows the use of surface mount manufacturing techniques.

Electrical Specifications, $T_A = +25^\circ C$, $V_{dd} = +5V$, $IF = 1 GHz$, $LO = 0 dBm^*$

Parameter	Min.	Typ.	Max.	Units
Frequency Range, RF/LO		10 - 16		GHz
Frequency Range, IF		DC - 3.5		GHz
Conversion Loss		8	11	dB
Image Rejection		25		dB
1 dB Compression (Input)		13		dBm
LO to RF Isolation		30		dB
RF to IF1 Isolation		45		dB
RF to IF2 Isolation		40		dB
IP3 (Input)		25		dBm
Supply Current (I _{dd})		114	154	mA

* Unless otherwise noted, all measurements performed as downconverter.



Data Taken As IRM With External IF Hybrid

Conversion Gain vs. Temperature

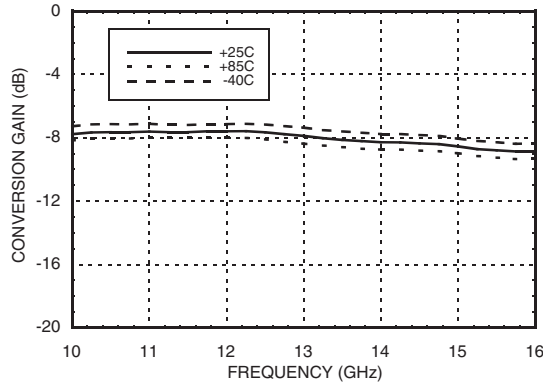
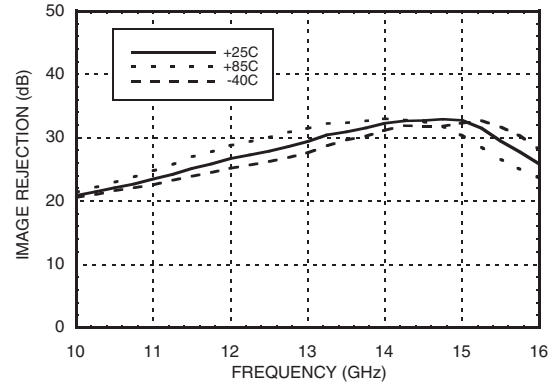
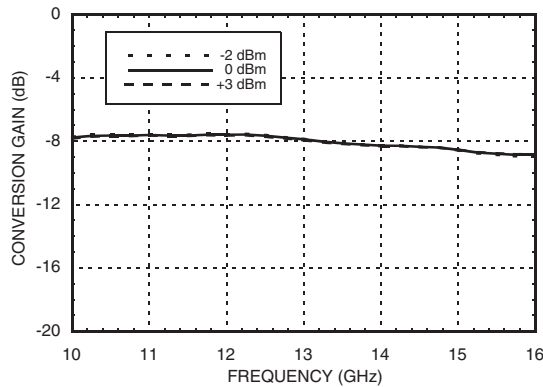

Image Rejection vs. Temperature



Conversion Gain vs. LO Drive



Return Loss

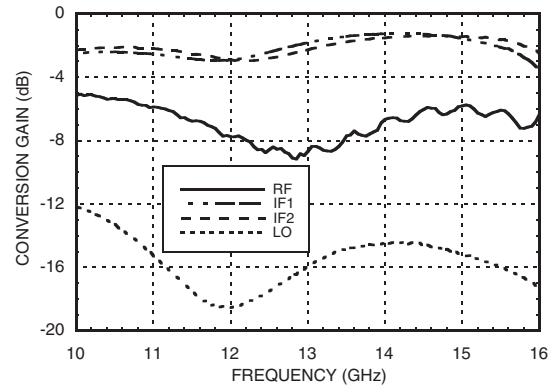

Input P1dB vs. Temperature

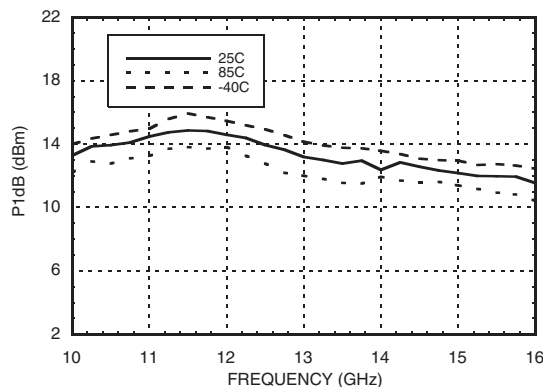

Input P1dB vs. LO Drive

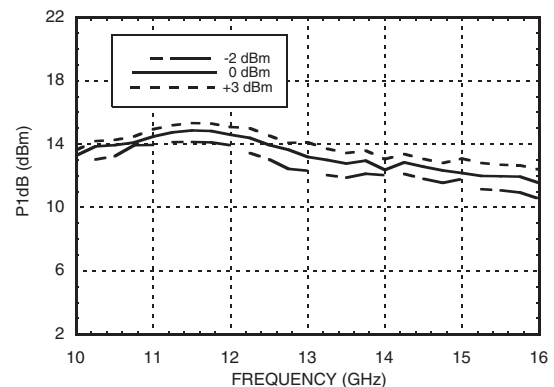



HMC775LC5

GaAs MMIC I/Q MIXER W/ LO AMPLIFIER, 10 - 16 GHz

Input IP3 vs. Temperature

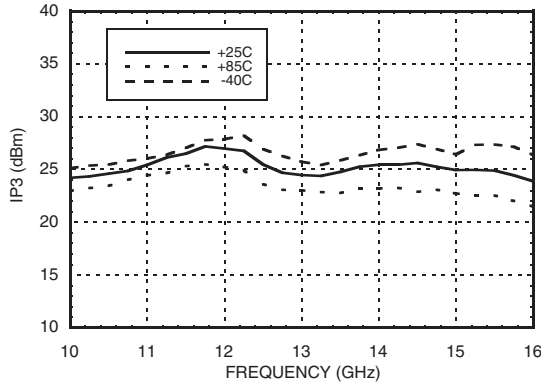

Input IP3 vs. LO Drive

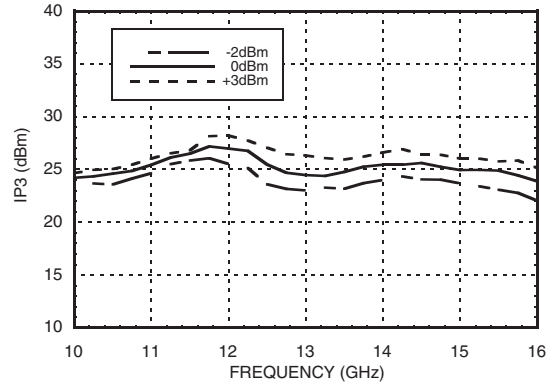

Isolations

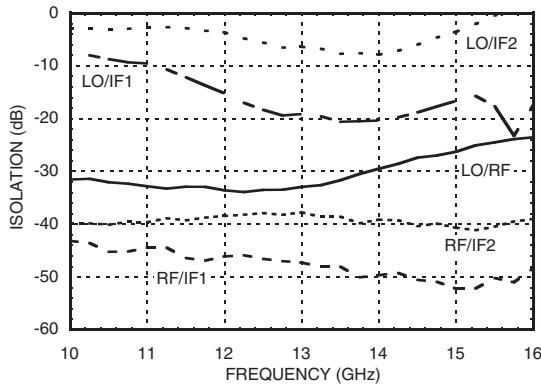

IF Bandwidth*

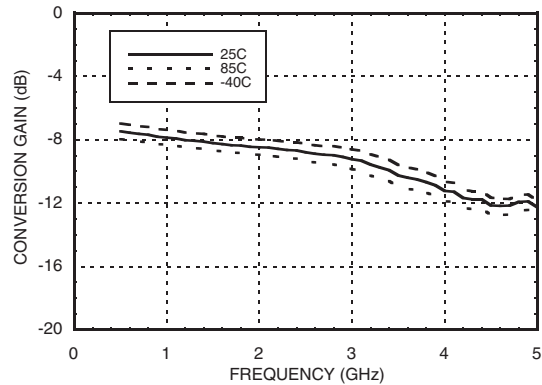

**Upconverter LSB, IF= 1 GHz
Conversion Gain vs. Temperature**

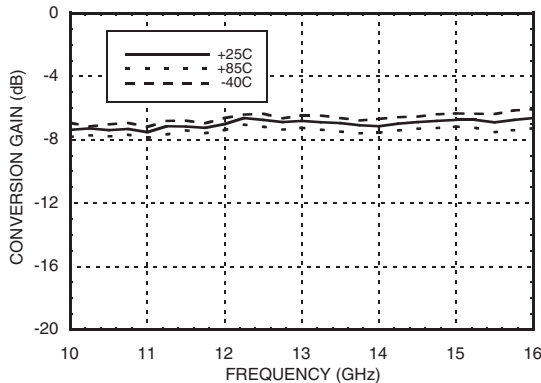

**Upconverter LSB, IF= 3 GHz
Conversion Gain vs. Temperature**

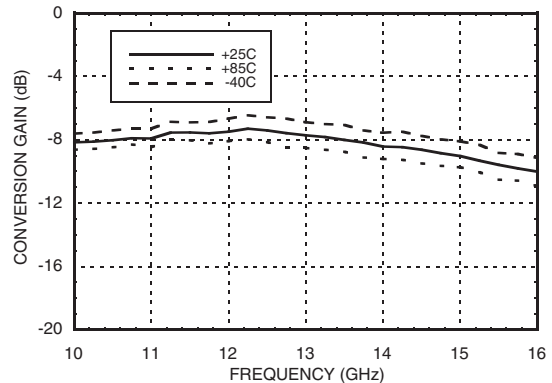

* Conversion gain data taken with external IF hybrid



HMC775LC5

GaAs MMIC I/Q MIXER W/ LO AMPLIFIER, 10 - 16 GHz

**Upconverter LSB, IF= 1 GHz
Conversion Gain vs. LO Drive**

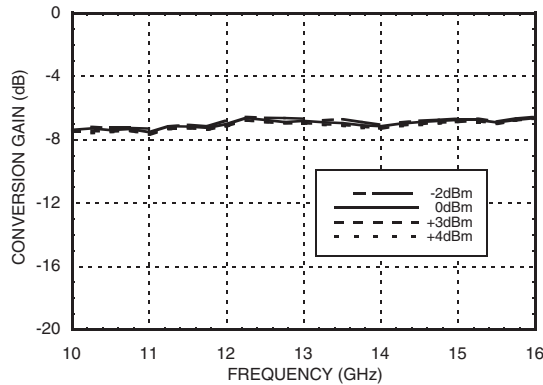

**Upconverter LSB, IF= 3 GHz
Conversion Gain vs. LO Drive**

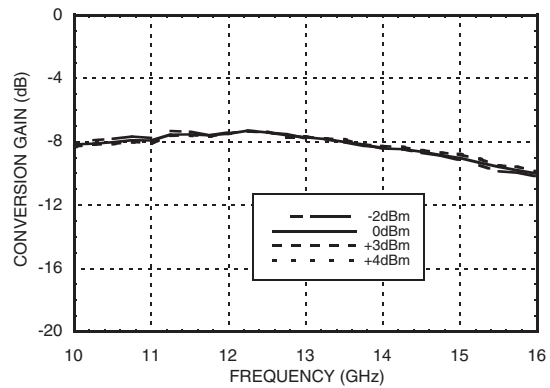

**Upconverter USB, IF= 1 GHz
Conversion Gain vs. Temperature**

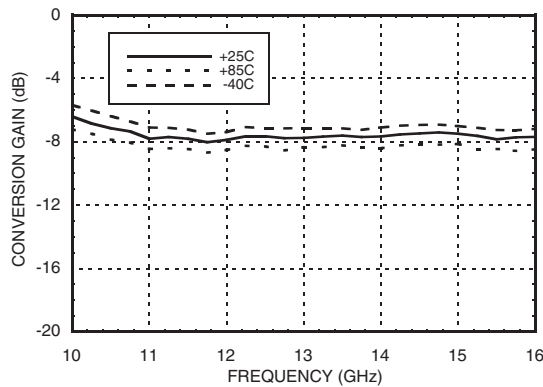

**Upconverter USB, IF= 3 GHz
Conversion Gain vs. Temperature**

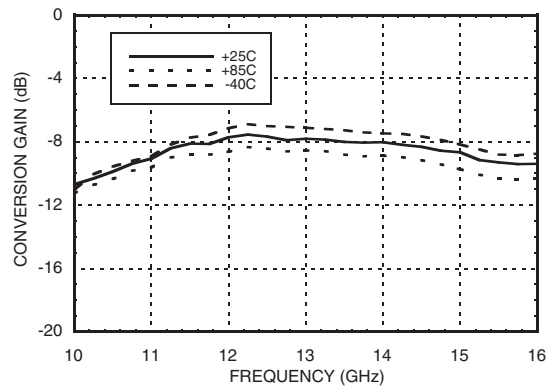

**Upconverter USB, IF= 1 GHz
Conversion Gain vs. LO Drive**

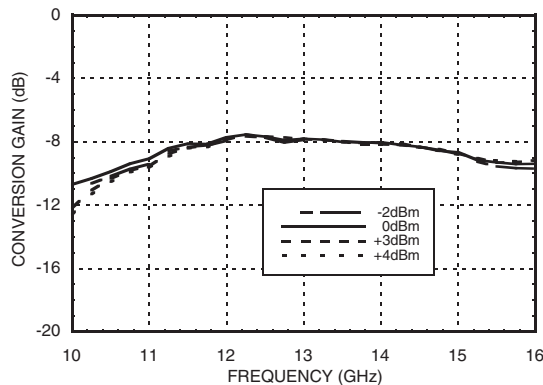

**Upconverter USB, IF= 3 GHz
Conversion Gain vs. LO Drive**

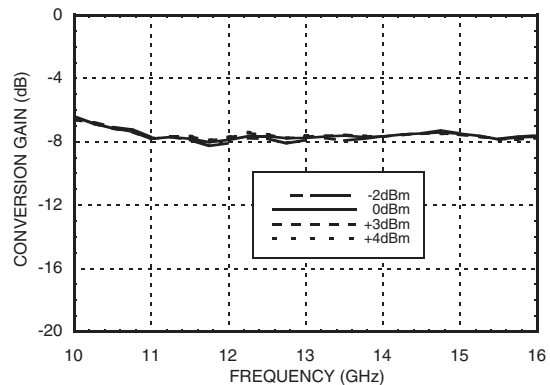

Sideband Rejection vs. LO Drive

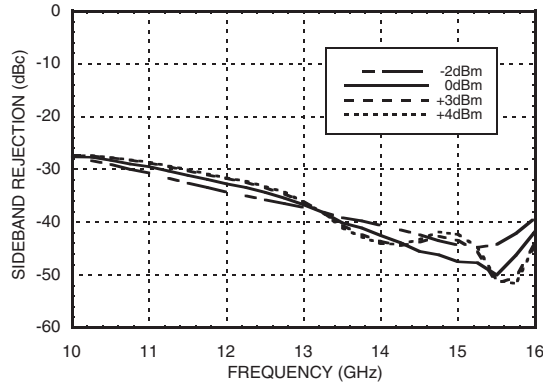

Harmonics of LO

LO Freq. (GHz)	nLO Spur at RF Port			
	1	2	3	4
10.5	34	29	44	76
11.5	36	38	58	71
12.5	37	42	63	59
13.5	40	44	79	xx
14.5	35	47	68	xx
15.5	31	46	61	xx

LO = 0 dBm
Values in dBc below input LO level measured at RF Port.

MxN Spurious Outputs

mRF	nLO				
	0	1	2	3	4
0	xx	7	22	49	xx
1	39	0	55	50	78
2	81	70	64	65	102
3	98	98	106	81	103
4	xx	96	108	105	117

RF = 13.6 GHz @ -10 dBm
LO = 13.5 GHz @ 0 dBm
Data taken without IF hybrid
All values in dBc below IF power level

Absolute Maximum Ratings

Drain Bias Voltage (Vdd)	+5.5V
RF / IF Input	+20 dBm
LO Input Power (LO)(Vdd = +5 Vdc)	+10 dBm
Channel Temperature	175 °C
Continuous Pdiss (T=85°C) (derate 12.4 mW/°C above 85°C)	1.1 W
Thermal Resistance (R _{TH}) (channel to ground paddle)	80 °C/W
Storage Temperature	-65 to +150 °C
Operating Temperature	-40 to +85 °C
ESD Sensitivity (HBM)	Class 1A



ELECTROSTATIC SENSITIVE DEVICE
OBSERVE HANDLING PRECAUTIONS

For price, delivery, and to place orders, please contact Hittite Microwave Corporation:

SUNSTAR 射频通信 at Road, Zhongshan Road / TEL: 0755-83396822 FAX: 0755-83376182 E-MAIL: szss20@163.com

Order On-line at www.hittite.com



Outline Drawing

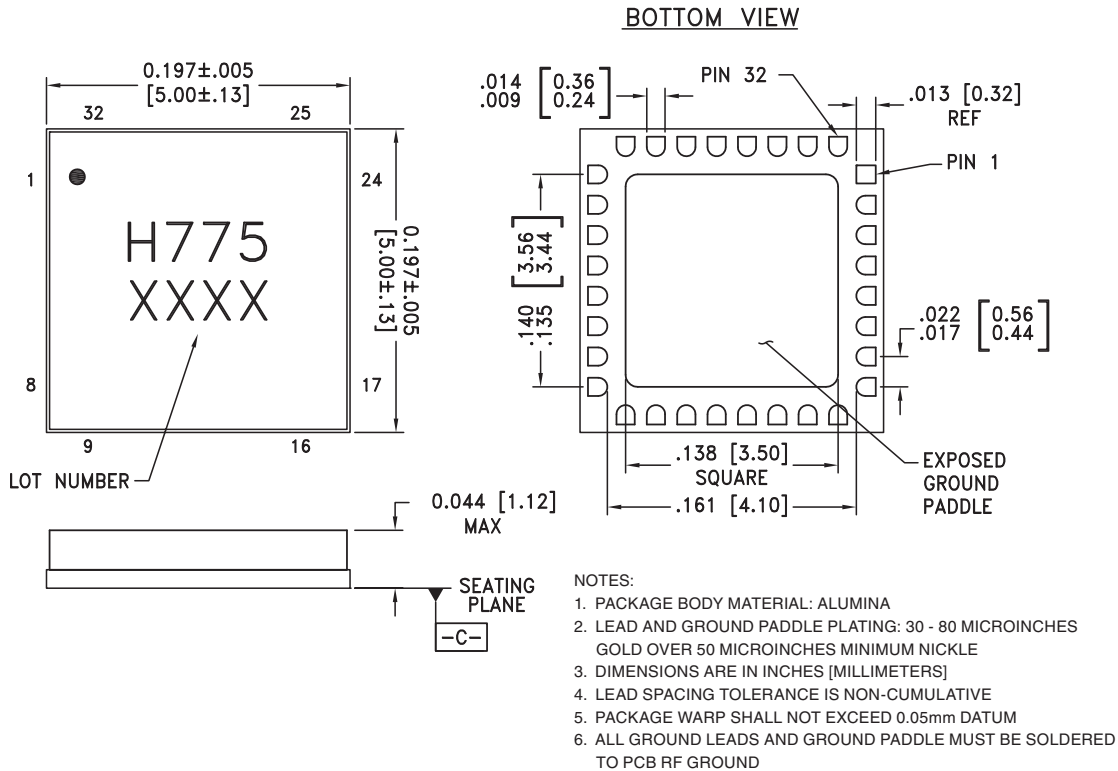

Pin Descriptions

Pin Number	Function	Description	Interface Schematic
1 - 4, 8 - 12, 15 - 17, 21 - 29, 31, 32	N/C	No connection required. These pins may be connected to RF/DC ground without affecting performance.	
5, 7, 18, 20	GND	These pins and package bottom must be connected to RF/DC ground.	
6	LO	This pin is AC coupled and matched to 50 Ohms.	
13	IF1	This pin is DC coupled. For applications not requiring operation to DC, this port should be DC blocked externally using a series capacitor whose value has been chosen to pass the necessary IF frequency range. For operation to DC, this pin must not source/sink more than 3mA of current or part non-function and possible part failure will result.	
14	IF2		
19	RF	This pin is AC coupled and matched to 50 Ohms.	
30	Vdd	Power supply voltage for amplifier	

Application Circuit

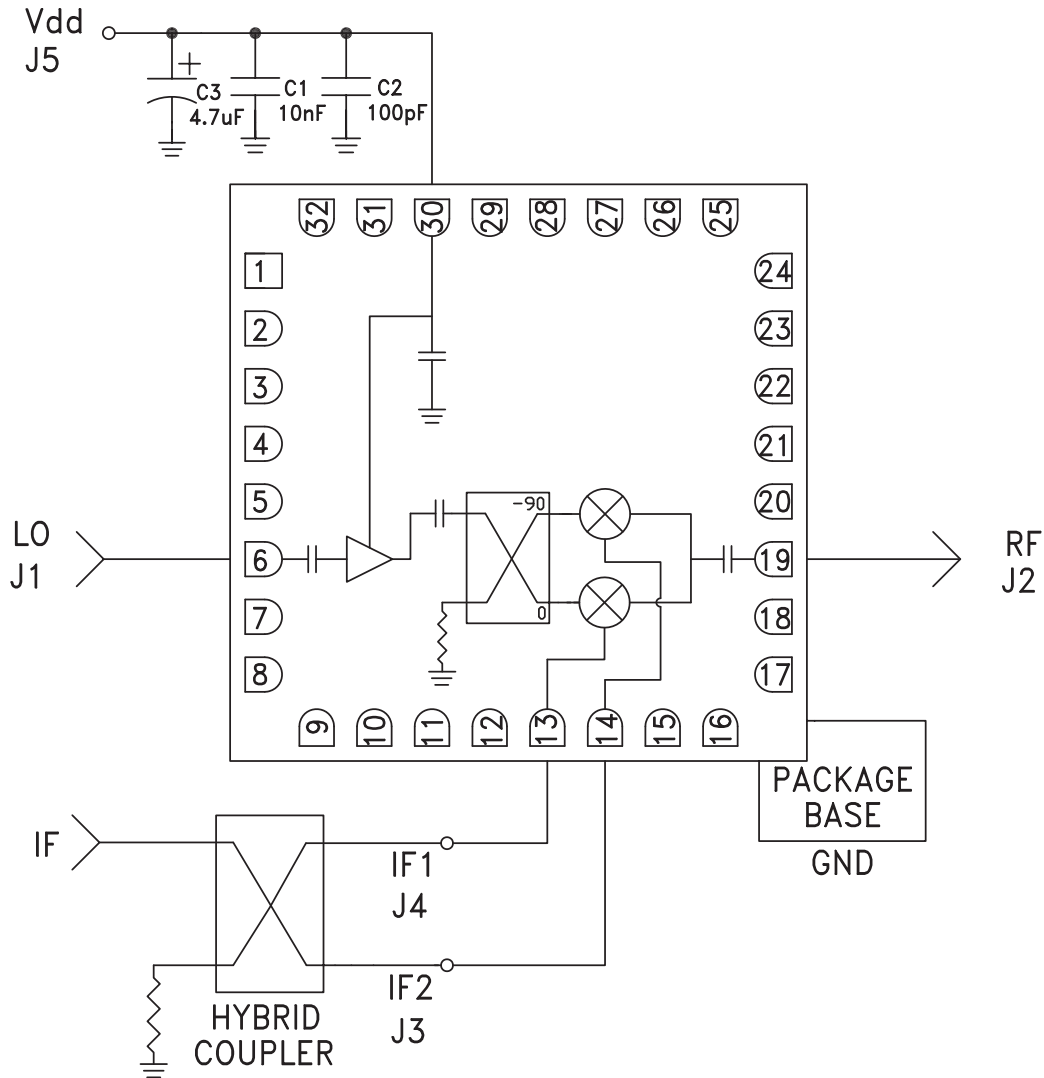



Evaluation PCB

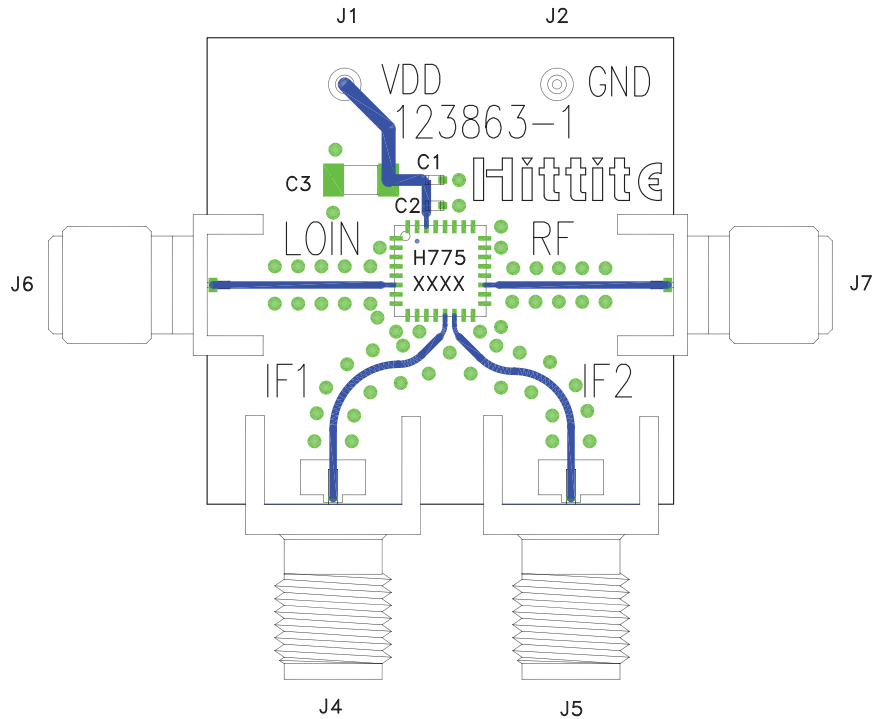

List of Materials for Evaluation PCB 123865 [1]

Item	Description
J1, J2	DC Pin
J4, J5	PCB Mount SMA RF Connector
J6, J7	SMA SRI Connector
C1	10 nF Capacitor, 0402 Pkg.
C2	100 pF Capacitor, 0402 Pkg.
C3	4.7 μF Tantalum, 3216 Pkg.
U1	HMC775LC5 Mixer
PCB [2]	123863 Evaluation Board

The circuit board used in the final application should use RF circuit design techniques. Signal lines should have 50 ohm impedance while the package ground leads and exposed paddle should be connected directly to the ground plane similar to that shown. A sufficient number of via holes should be used to connect the top and bottom ground planes. The evaluation circuit board shown is available from Hittite upon request.

[1] Reference this number when ordering complete evaluation PCB
 [2] Circuit Board Material: Rogers 4350 or Arlon 25FR