

SS270W

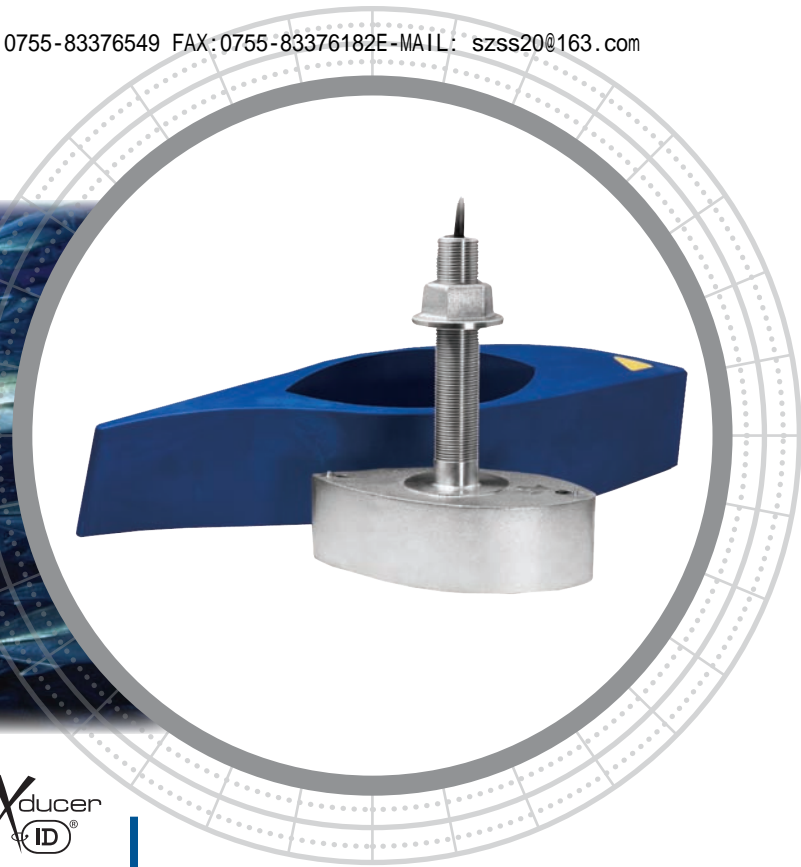

Get the WIDER View

The SS270W's extra wide coverage delivered to a dual-frequency, split-screen sounder gives fishermen a wider view of what is going on under the boat. The SS270W gives you four times the beamwidth at 200 kHz than other 1 kW, high-performance transducers. Since the beams are the same at both frequencies, a split-screen fishfinder display will clearly show the same water column and bottom coverage. Fish may also appear as arches. More fish will be marked while cruising, trolling, drifting, or at anchor.

- **Tuna/Marlin Fishermen**—Detect bait and gamefish in the upper-water column that would go unseen with a traditional narrow-beam transducer.
- **Downrigger Fishermen**—Track your downrigger balls and lures on the screen at both frequencies. This allows you to adjust the downrigger settings to maximize the lure or bait presentation at a desired depth.
- **Jig Fishermen**—Seeing your jigs descend on the echosounder screen while bottom fishing can help avoid bottom hang-ups when fishing in heavy currents. Seeing a tuna attack your jigs on the echosounder display lets you reel up other loose lines before tangles can occur.

The SS270W's custom-fit High-Performance Fairing will give crystal-clear imaging at speeds up to 30 knots (34 MPH). And since the SS270W fits into the popular B260 fairing pocket, it's easy to upgrade existing installations. Possibilities expand with the SS270W Transducer.



Sensing technology

Thru-Hull Wide-Beam 1 kW HD Digital

Fishing Applications

- Blue-water trolling using both 50 kHz and 200 kHz
- Bait and game fish marking in shallow to mid-water
- Wreck and structure finding on the continental shelf
- Vertical deep jigging
- Downrigger fishing in saltwater or deep-water lakes

Features

- Identical wide 25° beamwidths at 50 kHz and 200 kHz
- Provides 4 times the beamwidth at 200 kHz than other high-performance transducers
- Wide-beam is ideal for marking bait fish and game fish
- Vast bottom coverage in shallow-water
- Same targets appear at both frequencies
- Excellent fish detection in shallow to mid-water depths
- Retrofits into existing B260 fairing pocket
- Depth and fast-response water-temperature sensor
- Boat Size: 9 m (30') and up

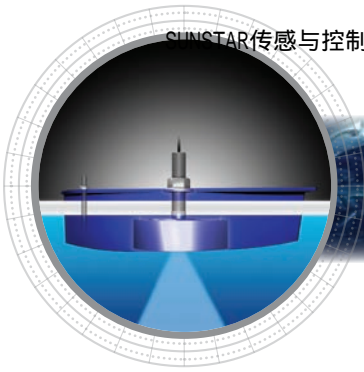

Technical Information

50 kHz-AWIq / 200 kHz-BM

Number of Elements and Configuration		
Beamwidth (@-3 dB)	25°	25°
RMS Power (W)	1 kW	1 kW
TVR	161 dB	165 dB
RVR	-175 dB	-194 dB
FOM	-19 dB	-30 dB
Q	4	7
Impedance	200 Ω	90 Ω

MAXIMUM DEPTH RANGE

50 kHz	200 kHz
400 m to 610 m (1,350' to 2,000')	100 m to 180 m (330' to 600')

BEAM DIAMETER VS DEPTH

Depth	50 kHz	200 kHz
9 m (30')	4 m (13')	4 m (13')
30 m (100')	14 m (45')	14 m (45')
122 m (400')	55 m (180')	55 m (180')
305 m (1,000')	137 m (450')	137 m (450')

SPECIFICATIONS

Weight: 7.3 kg (16 lb)

Hull Deadrise: Up to 20° with fairing

Acoustic Window: Urethane

DIMENSIONS

Transducer and High-Performance Fairing

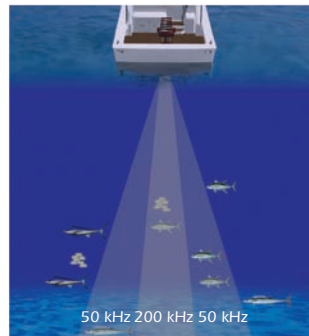
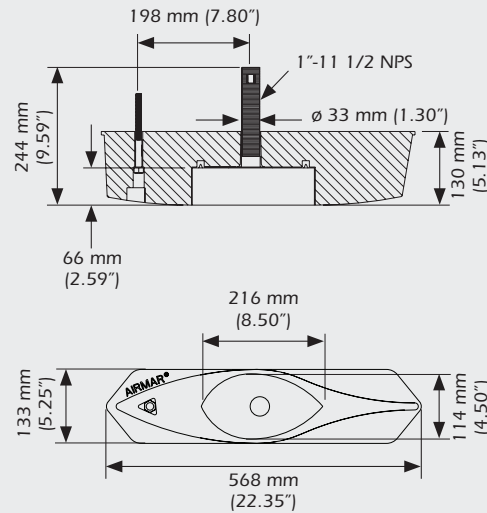

Standard 1 kW transducer
19° at 50 kHz, 6° at 200 kHz

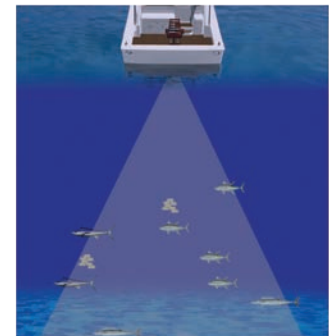

SS270W twin wide-beam transducer
Identical 25° beamwidths at 50 kHz and 200 kHz

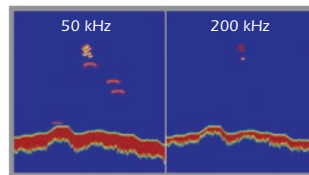

Different number of fish detected—
fish and bottom do not appear the same

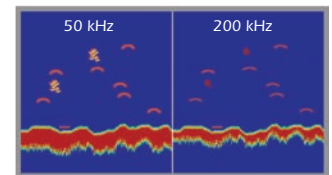

See the same targets at both frequencies—
allows for easier species and bottom identification