



## Silicon PIN Photodiode

### Description

BPV22F is a high speed and high sensitive PIN photodiode in a plastic package with a spherical side view lens. The epoxy package itself is an IR filter, spectrally matched to GaAs or GaAs/GaAlAs IR emitters ( $\lambda_p = 950 \text{ nm}$ ).

Lens radius and chip position are perfectly matched to the chip size, giving high sensitivity without compromising the viewing angle.

In comparison with flat packages the spherical lens package achieves a sensitivity improvement of 80 %.

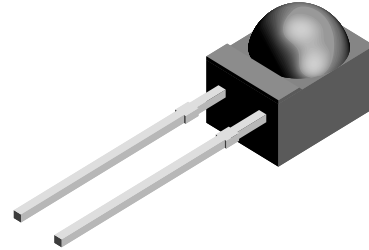

94 8633

### Features

- Large radiant sensitive area ( $A = 7.5 \text{ mm}^2$ )
- Wide viewing angle  $\varphi = \pm 60^\circ$
- Improved sensitivity
- Fast response times
- Plastic package with IR filter
- Filter designed for 950 nm transmission
- Lead-(Pb)-free component
- Component in accordance to RoHS 2002/95/EC and WEEE 2002/96/EC



### Applications

Infrared remote control and free air transmission systems in combination with IR emitter diodes (TSU...- or TSI...-Series).

### Absolute Maximum Ratings

$T_{amb} = 25^\circ\text{C}$ , unless otherwise specified

Parameter	Test condition	Symbol	Value	Unit
Reverse Voltage		$V_R$	60	V
Power Dissipation	$T_{amb} \leq 25^\circ\text{C}$	$P_V$	215	mW
Junction Temperature		$T_j$	100	$^\circ\text{C}$
Operating Temperature Range		$T_{amb}$	- 55 to + 100	$^\circ\text{C}$
Storage Temperature Range		$T_{stg}$	- 55 to + 100	$^\circ\text{C}$
Soldering Temperature	$t \leq 5 \text{ s}$	$T_{sd}$	260	$^\circ\text{C}$
Thermal Resistance Junction/Ambient		$R_{thJA}$	350	K/W

**BPV22F****Vishay Semiconductors****Electrical Characteristics**T<sub>amb</sub> = 25 °C, unless otherwise specified

Parameter	Test condition	Symbol	Min	Typ.	Max	Unit
Forward Voltage	I <sub>F</sub> = 50 mA	V <sub>F</sub>		1	1.3	V
Breakdown Voltage	I <sub>R</sub> = 100 μA, E = 0	V <sub>(BR)</sub>	60			V
Reverse Dark Current	V <sub>R</sub> = 10 V, E = 0	I <sub>ro</sub>		2	30	nA
Diode capacitance	V <sub>R</sub> = 0 V, f = 1 MHz, E = 0	C <sub>D</sub>		70		pF
Serial Resistance	V <sub>R</sub> = 12 V, f = 1 MHz	R <sub>S</sub>		400		Ω

**Optical Characteristics**T<sub>amb</sub> = 25 °C, unless otherwise specified

Parameter	Test condition	Symbol	Min	Typ.	Max	Unit
Open Circuit Voltage	E <sub>e</sub> = 1 mW/cm <sup>2</sup> , λ = 950 nm	V <sub>o</sub>		370		mV
Temp. Coefficient of V <sub>o</sub>	E <sub>e</sub> = 1 mW/cm <sup>2</sup> , λ = 950 nm	TK <sub>V<sub>o</sub></sub>		- 2.6		mV/K
Short Circuit Current	E <sub>e</sub> = 1 mW/cm <sup>2</sup> , λ = 950 nm	I <sub>k</sub>		75		μA
Reverse Light Current	E <sub>e</sub> = 1 mW/cm <sup>2</sup> , λ = 950 nm, V <sub>R</sub> = 5 V	I <sub>ra</sub>	55	80		μA
Temp. Coefficient of I <sub>ra</sub>	E <sub>e</sub> = 1 mW/cm <sup>2</sup> , λ = 950 nm, V <sub>R</sub> = 10 V	TK <sub>I<sub>ra</sub></sub>		0.1		%/K
Absolute Spectral Sensitivity	V <sub>R</sub> = 5 V, λ = 870 nm	s(λ)		0.35		A/W
	V <sub>R</sub> = 5 V, λ = 950 nm	s(λ)		0.6		A/W
Angle of Half Sensitivity		φ		± 60		deg
Wavelength of Peak Sensitivity		λ <sub>p</sub>		950		nm
Range of Spectral Bandwidth		λ <sub>0.5</sub>		870 to 1050		nm
Quantum Efficiency	λ = 950 nm	η		90		%
Noise Equivalent Power	V <sub>R</sub> = 10 V, λ = 950 nm	NEP		4 x 10 <sup>-14</sup>		W/√ Hz
Detectivity	V <sub>R</sub> = 10 V, λ = 950 nm	D <sup>*</sup>		6 x 10 <sup>12</sup>		cm <sup>2</sup> /Hz/W
Rise Time	V <sub>R</sub> = 10 V, R <sub>L</sub> = 1 kΩ, λ = 820 nm	t <sub>r</sub>		100		ns
Fall Time	V <sub>R</sub> = 10 V, R <sub>L</sub> = 1 kΩ, λ = 820 nm	t <sub>f</sub>		100		ns
Cut-Off Frequency	V <sub>R</sub> = 12 V, R <sub>L</sub> = 1 kΩ, λ = 870 nm	f <sub>c</sub>		4		MHz
	V <sub>R</sub> = 12 V, R <sub>L</sub> = 1 kΩ, λ = 950 nm	f <sub>c</sub>		1		MHz



**Typical Characteristics (Tamb = 25 °C unless otherwise specified)**

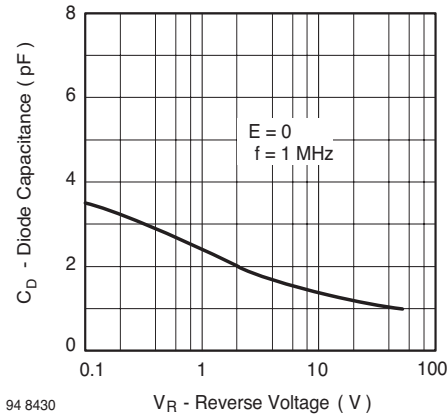

Figure 1. Reverse Dark Current vs. Ambient Temperature

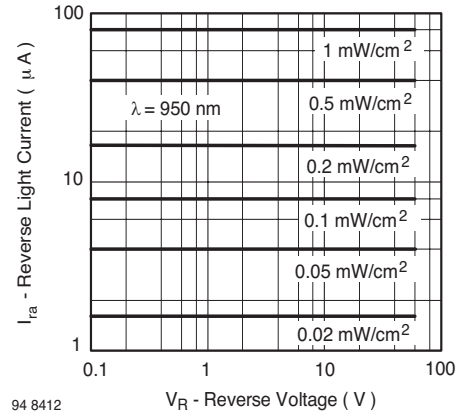

Figure 4. Reverse Light Current vs. Reverse Voltage

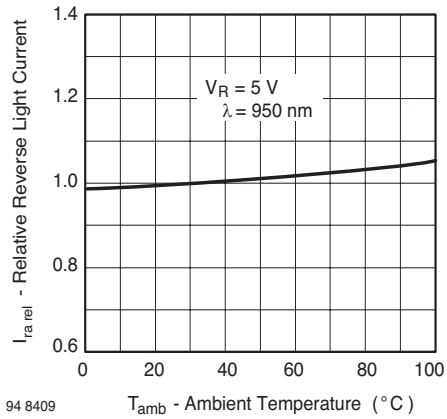

Figure 2. Relative Reverse Light Current vs. Ambient Temperature

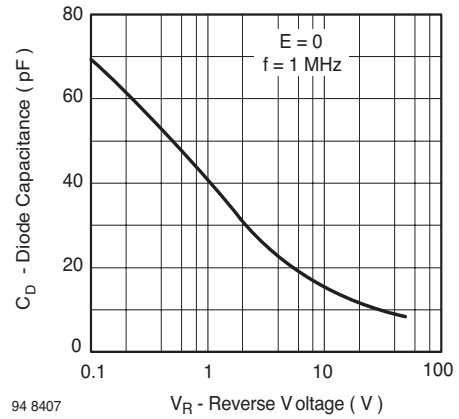

Figure 5. Diode Capacitance vs. Reverse Voltage

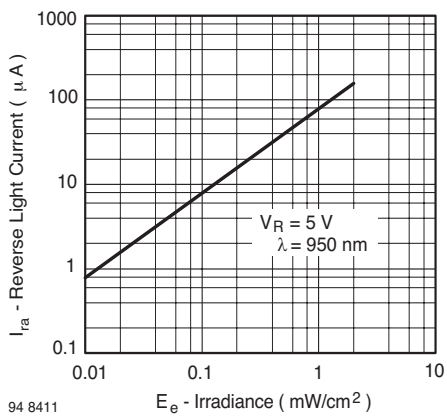

Figure 3. Reverse Light Current vs. Irradiance

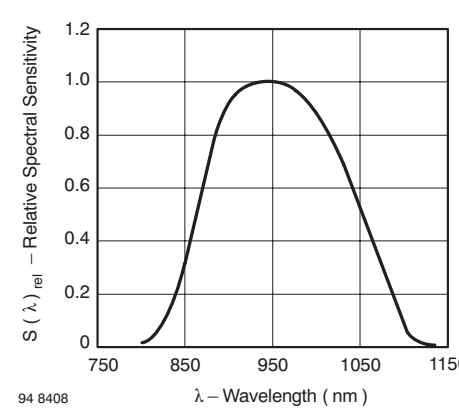
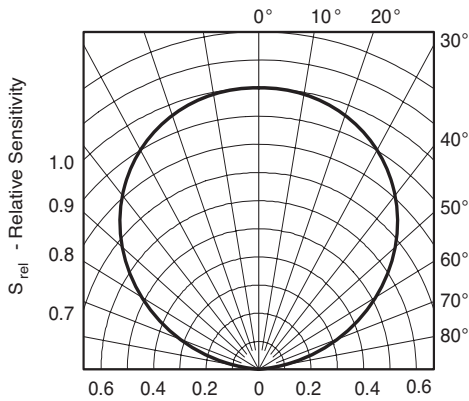

Figure 6. Relative Spectral Sensitivity vs. Wavelength

# BPV22F



Vishay Semiconductors



94 8413

Figure 7. Relative Radiant Sensitivity vs. Angular Displacement

## Package Dimensions in mm

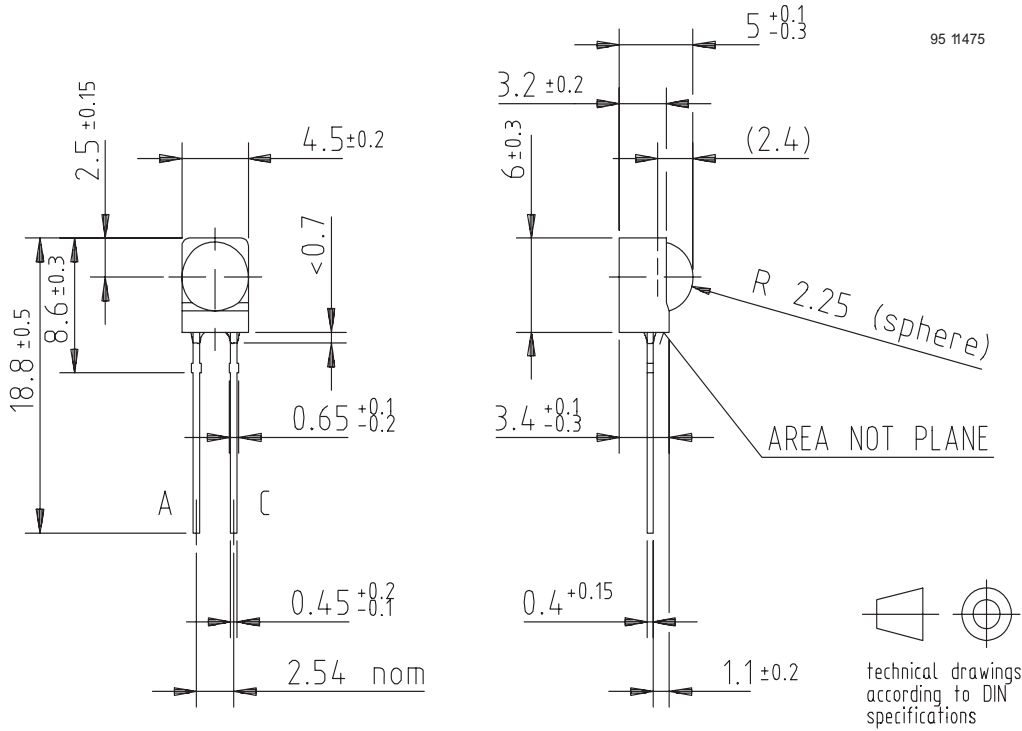



## Ozone Depleting Substances Policy Statement

It is the policy of Vishay Semiconductor GmbH to

1. Meet all present and future national and international statutory requirements.
2. Regularly and continuously improve the performance of our products, processes, distribution and operating systems with respect to their impact on the health and safety of our employees and the public, as well as their impact on the environment.

It is particular concern to control or eliminate releases of those substances into the atmosphere which are known as ozone depleting substances (ODSs).

The Montreal Protocol (1987) and its London Amendments (1990) intend to severely restrict the use of ODSs and forbid their use within the next ten years. Various national and international initiatives are pressing for an earlier ban on these substances.

Vishay Semiconductor GmbH has been able to use its policy of continuous improvements to eliminate the use of ODSs listed in the following documents.

1. Annex A, B and list of transitional substances of the Montreal Protocol and the London Amendments respectively
2. Class I and II ozone depleting substances in the Clean Air Act Amendments of 1990 by the Environmental Protection Agency (EPA) in the USA
3. Council Decision 88/540/EEC and 91/690/EEC Annex A, B and C (transitional substances) respectively.

Vishay Semiconductor GmbH can certify that our semiconductors are not manufactured with ozone depleting substances and do not contain such substances.

We reserve the right to make changes to improve technical design  
and may do so without further notice.

Parameters can vary in different applications. All operating parameters must be validated for each customer application by the customer. Should the buyer use Vishay Semiconductors products for any unintended or unauthorized application, the buyer shall indemnify Vishay Semiconductors against all claims, costs, damages, and expenses, arising out of, directly or indirectly, any claim of personal damage, injury or death associated with such unintended or unauthorized use.

Vishay Semiconductor GmbH, P.O.B. 3535, D-74025 Heilbronn, Germany