

PT370/PT371/PT372

Compact, Stem Type Phototransistor

T-41-61
T-41-03

■ Features

1. $\phi 3\text{mm}$ compact, resin stem type
2. Acceptance PT370 $\Delta \theta$: TYP. $\pm 45^\circ$
 PT371 $\Delta \theta$: TYP. $\pm 65^\circ$
 PT372 $\Delta \theta$: TYP. $\pm 70^\circ$
3. Single phototransistor output: PT370/PT371
 Darlington phototransistor output: PT372

■ Applications

1. Floppy disk drives
2. VCRs,
3. Automatic stroboscopes
4. Optoelectronic switches, optoelectronic counters

■ Outline Dimensions

(Unit : mm)

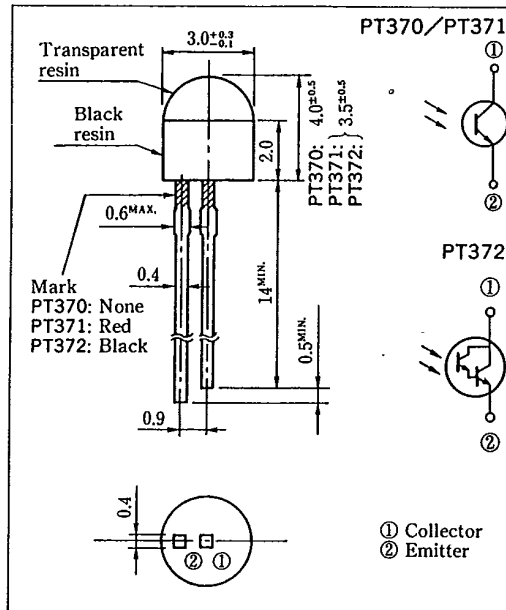

■ Absolute Maximum Ratings

($T_a = 25^\circ\text{C}$)

Parameter	Symbol	Rating	Unit
Collector-emitter voltage	V_{CE0}	35	V
Emitter-collector voltage	V_{ECO}	6	V
Collector current	I_c	20	mA
		50	
Collector power dissipation	P_c	75	mW
Operating temperature	T_{opr}	$-25 \sim +85$	$^\circ\text{C}$
Storage temperature	T_{stg}	$-25 \sim +85$	$^\circ\text{C}$
*1 Soldering temperature	T_{sol}	260	$^\circ\text{C}$

*1 For 3 seconds at the position of 1.5mm from the bottom face of resin package

SHARP

Electro-optical Characteristics

T-41-63

(T_a=25°C)

Parameter	Symbol	Conditions	MIN.	TYP.	MAX.	Unit
*2Collector current	PT370	*3 E _v =100lx, V _{CE} =5V (PT372: V _{CE} =2V)	100	300	900	μA
	PT371		100	—	900	
	PT372		3.0	—	23	mA
Collector dark current	PT370/PT371	E _e =0, V _{CE} =20V	—	2.0	100	nA
	PT372	E _e =0, V _{CE} =10V	—	—	1.0	μA
Collector-emitter saturation voltage	PT370/PT371	*3E _e =10mW/cm ² , I _c =0.5mA	—	0.2	0.4	V
	PT372	*3E _e =1mW/cm ² , I _c =2.5mA	—	0.8	1.0	
Peak sensitivity wavelength	λ _p	—	—	800	—	nm
Response time (Rise)	PT370/PT371	V _{CC} =20V, I _c =1mA, R _L =1kΩ	—	10	40	μs
	PT372	V _{CE} =2V, I _c =10mA, R _L =100Ω	—	100	400	μs
Response time (Fall)	PT370/PT371	V _{CC} =20V, I _c =1mA, R _L =1kΩ	—	8	35	μs
	PT372	V _{CE} =2V, I _c =10mA, R _L =100Ω	—	100	400	μs
Half intensity angle	PT370	—	—	±45	—	deg.
	PT371		—	±65	—	
	PT372		—	±70	—	

*2 The collector current (I_c) shall be classified into the ranks as follows before delivery.

Rank	Collector current I _c		
	PT370 (μA)	PT371 (μA)	PT372 (mA)
A	100~216	100~244	3.0~9.66
B	170~320	192~463	7.14~23.0
C	252~533	363~900	—
D	419~900	—	—

*3 E_v, E_e: Illuminance, irradiance by CIE standard light source A (tungsten lamp)

Fig. 1 Collector Power Dissipation vs. Ambient Temperature

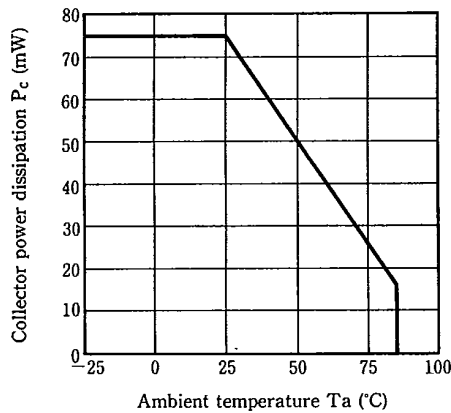
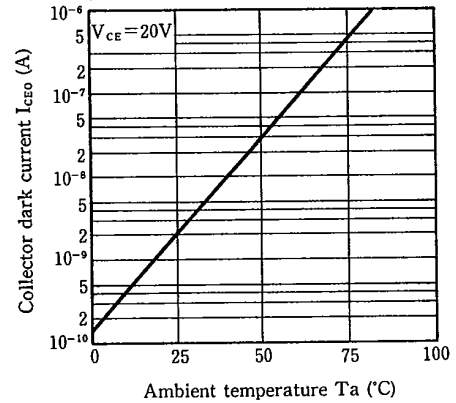

Fig. 2 Collector Dark Current vs. Ambient Temperature (PT370/PT371)



T-41-61

Fig. 3 Collector Dark Current vs. Ambient Temperature (PT372)

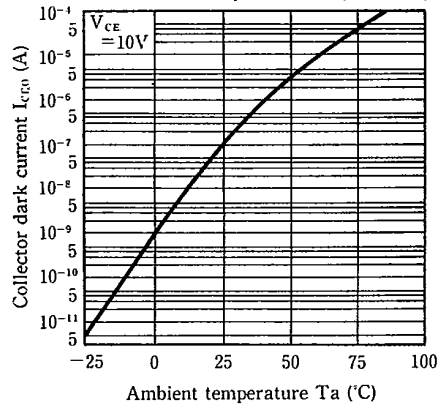

Fig. 5 Relative Collector Current vs. Ambient Temperature (PT372)

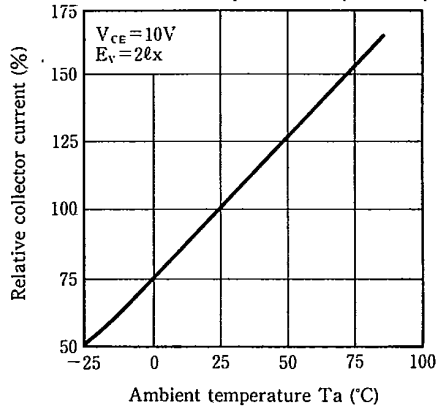
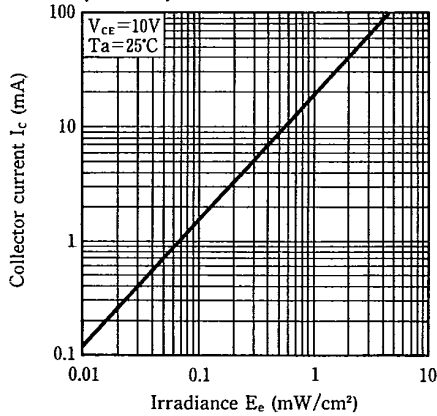

Fig. 7 Collector Current vs. Irradiance (PT372)



T-41-63

Fig. 4 Relative Collector Current vs. Ambient Temperature (PT370/PT371)

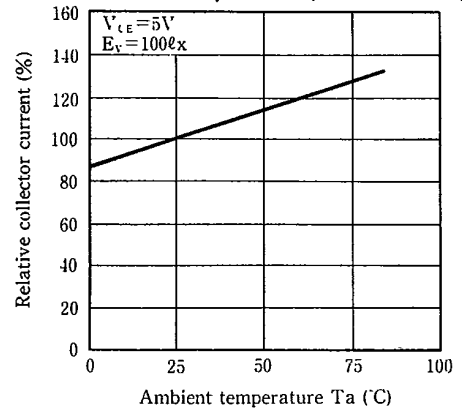

Fig. 6 Collector Current vs. Irradiance (PT370/PT371)

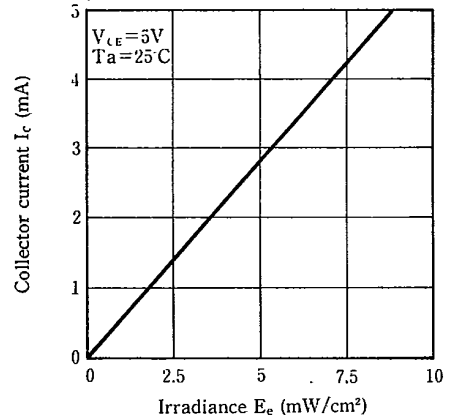

Fig. 8 Collector Current vs. Collector-emitter Voltage (PT370)

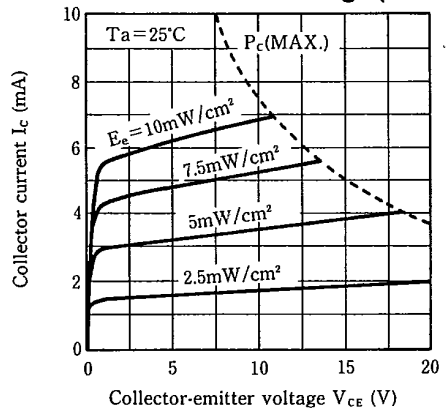

Fig. 9 Collector Current vs. Collector-emitter Voltage (PT371)

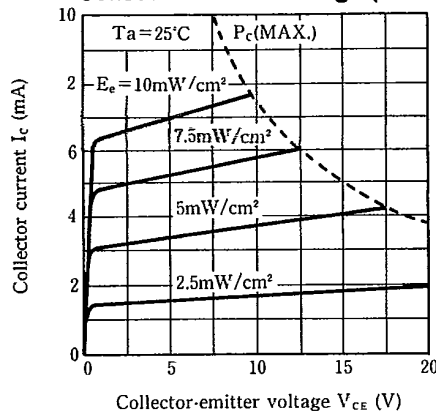

Fig. 10 Collector Current vs. Collector-emitter Voltage (PT372)

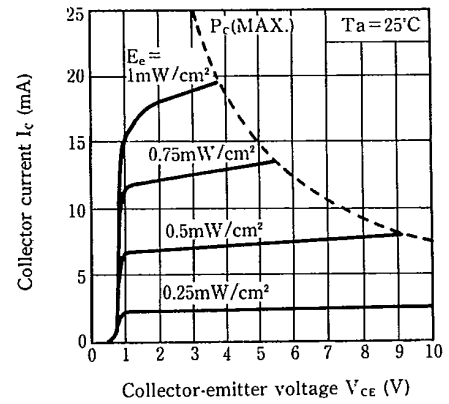

Fig. 11 Spectral Sensitivity

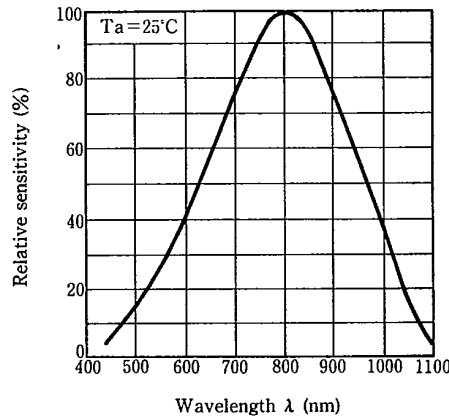

Fig. 12 Response Time vs. Load Resistance (PT370/PT371)

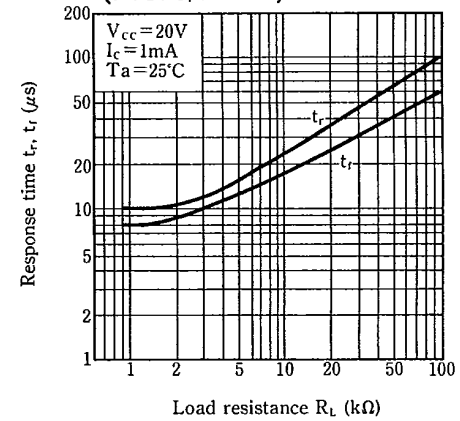
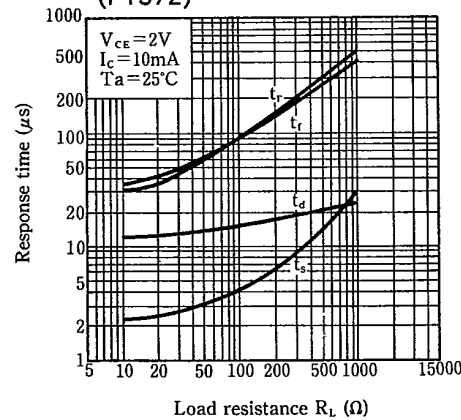

Fig. 13 Response Time vs. Load Resistance (PT372)



Test Circuit for Response Time

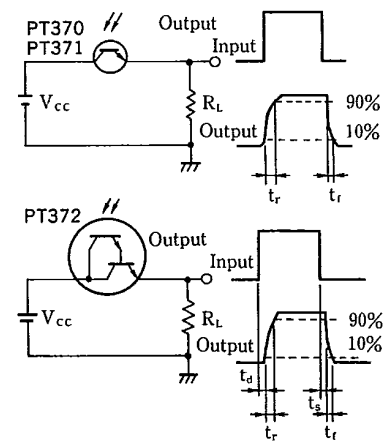

Fig. 14 Sensitivity Diagram (PT370)
($T_a = 25^\circ\text{C}$)

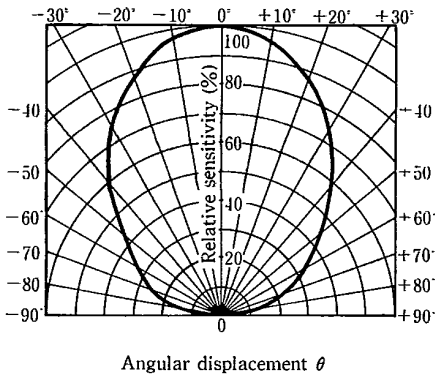

Fig. 15 Sensitivity Diagram (PT371)
($T_a = 25^\circ\text{C}$)

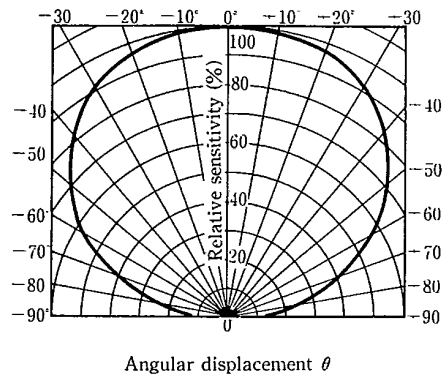

Fig. 16 Sensitivity Diagram (PT372)
($T_a = 25^\circ\text{C}$)

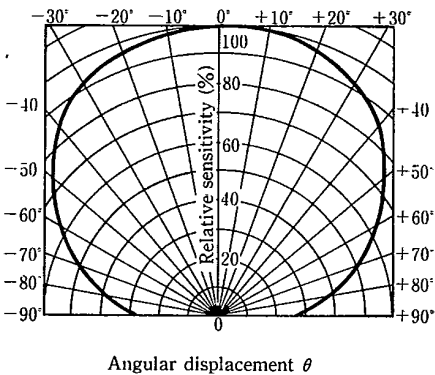

Fig. 17 Collector-emitter Saturation Voltage vs. Irradiance (PT370)

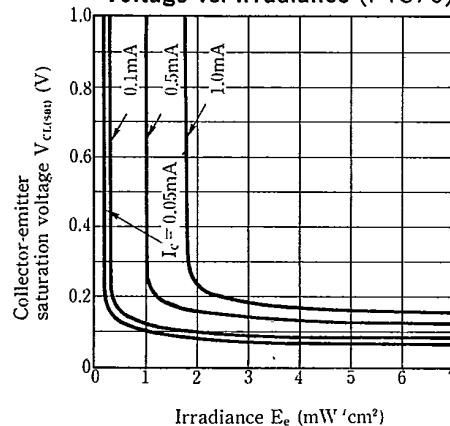

Fig. 18 Collector-emitter Saturation Voltage vs. Irradiance (PT371)

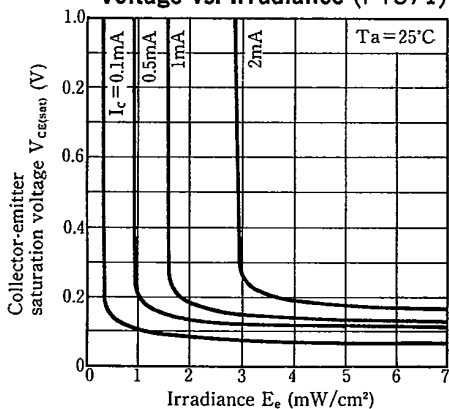

Fig. 19 Collector-emitter Saturation Voltage vs. Irradiance (PT372)

