

Photointerrupter, double-layer mold type

RPI-304

The RPI-304 is standard tall package photointerrupter. This product can be fix on PCB by snap.

●Application

Reel count sensor for VCR

●Features

- 1) Tall package (Optical axis 22.6mm)
- 2) Small package due to the double-layer mold
- 3) PPS package for heat resistance

●External dimensions (Units : mm)

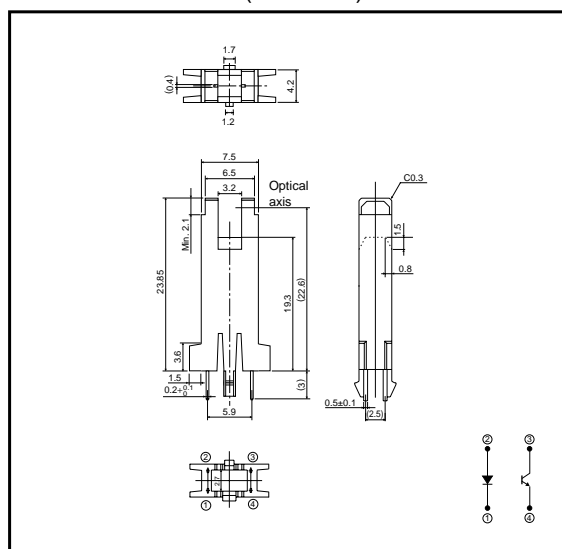

●Absolute maximum ratings (Ta = 25°C)

Parameter		Symbol	Limits	Unit
Input(LED)	Forward current	I_F	50	mA
	Reverse voltage	V_R	5	V
	Power dissipation	P_D	80	mW
Output (photo-transistor)	Collector-emitter voltage	V_{CE0}	30	V
	Emitter-collector voltage	V_{ECO}	4.5	V
	Collector current	I_C	30	mA
	Collector power dissipation	P_C	80	mW
Operating temperature		T_{opr}	-25→+85	°C
Storage temperature		T_{stg}	-30→+85	°C

Sensors

●Electrical and optical characteristics (Ta = 25°C)

	Parameter	Symbol	Min.	Typ.	Max.	Unit	Conditions
Input characteristics	Forward voltage	V_F	-	1.3	1.6	V	$I_F=50\text{mA}$
	Reverse current	I_R	-	-	10	μA	$V_R=5\text{V}$
Output characteristics	Dark current	I_{CE0}	-	-	0.5	μA	$V_{CE}=10\text{V}$
	Peak sensitivity wavelength	λ_P	-	800	-	nm	-
Transfer characteristics	Collector current	I_C	0.2	0.7	2.0	mA	$V_{CE}=5\text{V}, I_F=20\text{mA}$
	Collector-emitter saturation voltage	$V_{CE(sat)}$	-	-	0.4	V	$I_F=20\text{mA}, I_C=0.1\text{mA}$
	Response time	$t_r \cdot t_f$	-	10	-	μs	$V_{CC}=5\text{V}, I_F=20\text{mA}, R_L=100\Omega$

●Electrical and optical characteristic curves

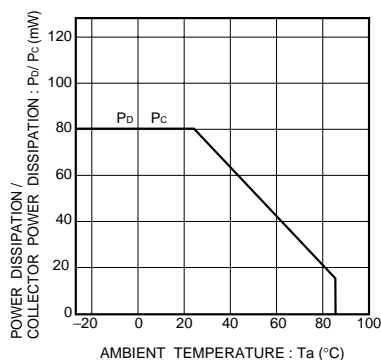

Fig.1 Power dissipation / collector power dissipation vs. ambient temperature

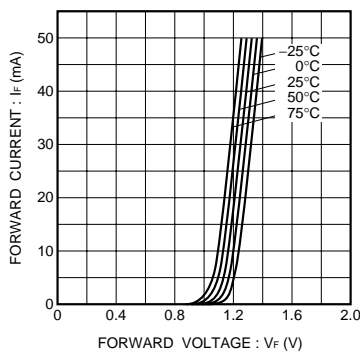

Fig.2 Forward current vs. forward voltage

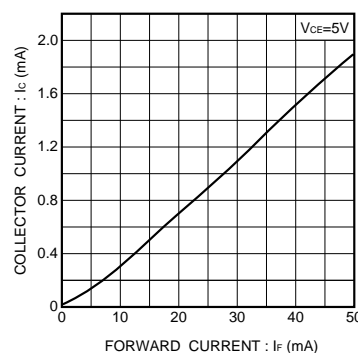

Fig.3 Collector current vs. forward current

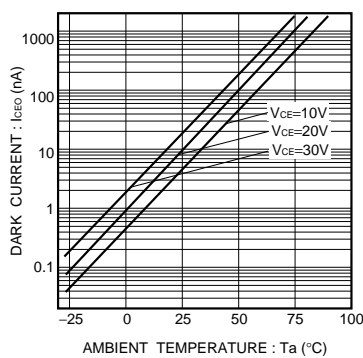

Fig.4 Dark current vs. ambient temperature

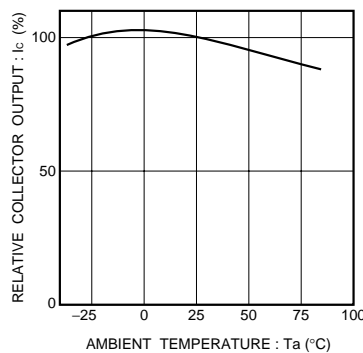

Fig.5 Relative output vs. ambient temperature

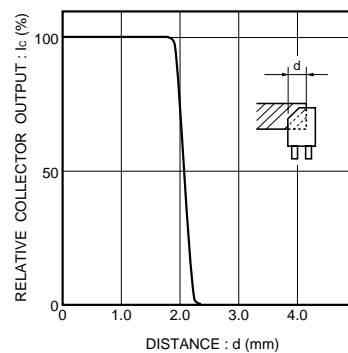

Fig.6 Relative output vs. distance

Sensors

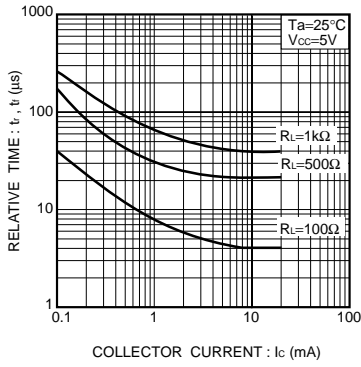

Fig.7 Response time vs. collector current

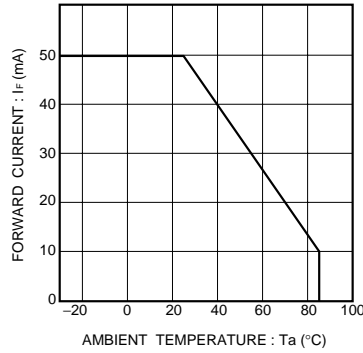

Fig.8 Forward current falloff

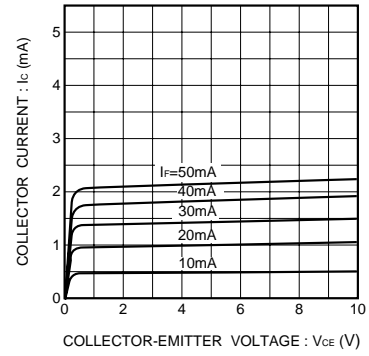

Fig.9 Output characteristics

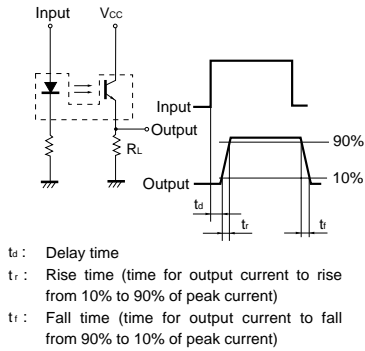

Fig.10 Response time measurement circuit

Appendix

Notes

- No technical content pages of this document may be reproduced in any form or transmitted by any means without prior permission of ROHM CO.,LTD.
- The contents described herein are subject to change without notice. The specifications for the product described in this document are for reference only. Upon actual use, therefore, please request that specifications to be separately delivered.
- Application circuit diagrams and circuit constants contained herein are shown as examples of standard use and operation. Please pay careful attention to the peripheral conditions when designing circuits and deciding upon circuit constants in the set.
- Any data, including, but not limited to application circuit diagrams information, described herein are intended only as illustrations of such devices and not as the specifications for such devices. ROHM CO.,LTD. disclaims any warranty that any use of such devices shall be free from infringement of any third party's intellectual property rights or other proprietary rights, and further, assumes no liability of whatsoever nature in the event of any such infringement, or arising from or connected with or related to the use of such devices.
- Upon the sale of any such devices, other than for buyer's right to use such devices itself, resell or otherwise dispose of the same, no express or implied right or license to practice or commercially exploit any intellectual property rights or other proprietary rights owned or controlled by
- ROHM CO., LTD. is granted to any such buyer.
- Products listed in this document use silicon as a basic material.
Products listed in this document are no antiradiation design.

The products listed in this document are designed to be used with ordinary electronic equipment or devices (such as audio visual equipment, office-automation equipment, communications devices, electrical appliances and electronic toys).

Should you intend to use these products with equipment or devices which require an extremely high level of reliability and the malfunction of which would directly endanger human life (such as medical instruments, transportation equipment, aerospace machinery, nuclear-reactor controllers, fuel controllers and other safety devices), please be sure to consult with our sales representative in advance.

About Export Control Order in Japan

Products described herein are the objects of controlled goods in Annex 1 (Item 16) of Export Trade Control Order in Japan.

In case of export from Japan, please confirm if it applies to "objective" criteria or an "informed" (by MITI clause) on the basis of "catch all controls for Non-Proliferation of Weapons of Mass Destruction.