

TOSHIBA PHOTOINTERRUPTER INFRARED LED + PHOTOTRANSISITOR

TLP1230(C4)

COPIER, LASER BEAM PRINTER

FACSIMILE, PRINTER, ELECTRONIC TYPEWRITER

AUTOMATIC VENDING MACHINE, TERMINAL
EQUIPMENT IN BANKING FACILITIES

VARIOUS POSITION DETECTION SENSOR

TLP1230 (C4) are photointerrupters with a connector using an GaAs infrared LED at the emitter side and a Si photo IC at the detector side respectively.

The phototransistor is turned off when a substance is detected (when the light is shielded).

This product is also usable in applications requiring severe using temperature condition such as detection of paper exit on copier, etc. connector)

- Small package
- Phototransistor output (Cathode, emitter common)
- Mountable by one touch (Snap-in mounting type)
- Mountable to boards in 2 kinds of thickness (1.0mm, 1.2mm)
- Gap : 5mm
- Resolution : Slit width 0.5mm
- Large operation temperature range : $T_{opr} = -25 \sim 95^{\circ}\text{C}$
- High current transfer ratio : $I_C / I_F = 5\%$ (min)
- UL recognized PWB adopted : UL94V-0
- Material of the case : Polycarbonate
- Connector : 53014-0310
(Molex Japan Co., Ltd. made 2mm pitch connector)

Unit in mm

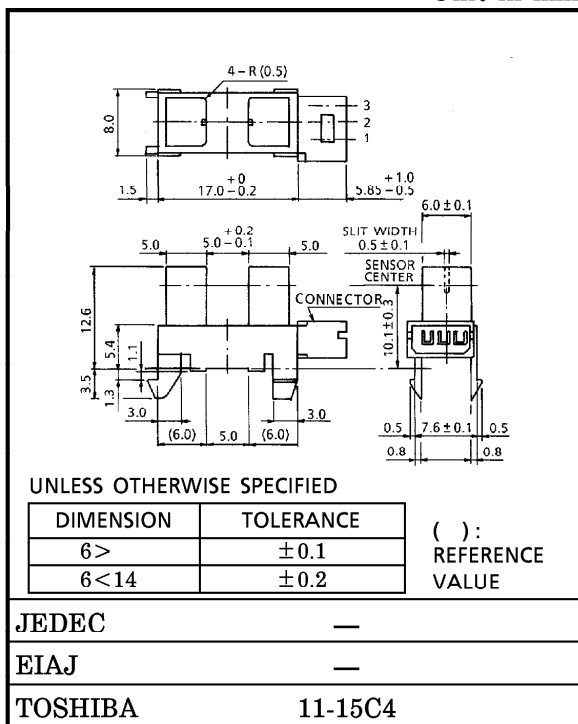

Weight : 1.1g (typ.)

961001EBC2

- TOSHIBA is continually working to improve the quality and the reliability of its products. Nevertheless, semiconductor devices in general can malfunction or fail due to their inherent electrical sensitivity and vulnerability to physical stress. It is the responsibility of the buyer, when utilizing TOSHIBA products, to observe standards of safety, and to avoid situations in which a malfunction or failure of a TOSHIBA product could cause loss of human life, bodily injury or damage to property. In developing your designs, please ensure that TOSHIBA products are used within specified operating ranges as set forth in the most recent products specifications. Also, please keep in mind the precautions and conditions set forth in the TOSHIBA Semiconductor Reliability Handbook.
- Gallium arsenide (GaAs) is a substance used in the products described in this document. GaAs dust and fumes are toxic. Do not break, cut or pulverize the product, or use chemicals to dissolve them. When disposing of the products, follow the appropriate regulations. Do not dispose of the products with other industrial waste or with domestic garbage.
- The products described in this document are subject to foreign exchange and foreign trade control laws.
- The information contained herein is presented only as a guide for the applications of our products. No responsibility is assumed by TOSHIBA CORPORATION for any infringements of intellectual property or other rights of the third parties which may result from its use. No license is granted by implication or otherwise under any intellectual property or other rights of TOSHIBA CORPORATION or others.
- The information contained herein is subject to change without notice.

PIN CONNECTION

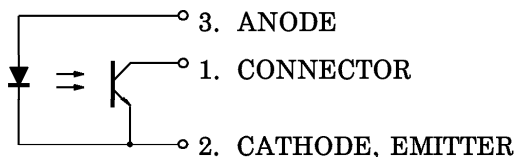

MAXIMUM RATINGS (Ta = 25°C)

CHARACTERISTIC	SYMBOL	RATING	UNIT
Forward Current	I_F	50	mA
Forward Current Derating	$\Delta I_F / ^\circ C$	Ta > 25°C	-0.33
		Ta > 85°C	-2
Reverse Voltage	V_R	5	V
Collector-Emitter Voltage	V_{CEO}	35	V
Emitter-Collector Voltage	V_{ECO}	5	V
Collector Power Dissipation	P_C	75	mW
Collector Power Dissipation Derating (Ta > 25°C)	$\Delta P_C / ^\circ C$	-1	mW / °C
Collector Current	I_C	50	mA
Operating Temperature Range	T_{opr}	-25~95	°C
Storage Temperature Range	T_{stg}	-40~100	°C

OPTO-ELECTRICAL CHARACTERISTICS (Ta = 25°C)

CHARACTERISTIC	SYMBOL	TEST CONDITION	MIN.	TYP.	MAX.	UNIT	
LED	Forward Voltage	V_F	$I_F = 10mA$	1.00	1.15	1.30	V
	Reverse Current	I_R	$V_R = 5V$	—	—	10	μA
	Peak Emission Wavelength	λ_P	$I_F = 20mA$	—	940	—	nm
DETECTOR	Dark Current	I_D	$V_{CE} = 24V, I_F = 0$	—	—	0.1	μA
	Peak Sensitivity Wavelength	λ_P	—	—	870	—	nm
COUPLED	Current Transfer Ratio	I_C / I_F	$V_{CE} = 5V, I_F = 20mA$	5	—	100	%
	Collector-Emitter Saturation Voltage	$V_{CE(sat)}$	$I_F = 20mA, I_C = 0.5mA$	—	0.15	0.4	V
	Rise Time	t_r	$V_{CC} = 5V, I_C = 2mA$ $R_L = 100\Omega$	—	6	—	μs
	Fall Time	t_f		—	6	—	

TERMINAL STRENGTH (Ta = 25°C)

CHARACTERISTIC	TEST CONDITION		LIMIT
PULL	DIRECTION	A	NO DEFECT OF ELECTRICAL CHARACTERISTICS
	WEIGHT	19.6N	
	TIME	5s / ONCE	
BEND	DIRECTION	B	
	WEIGHT	9.8N	
	TIME	5s / THRICE	

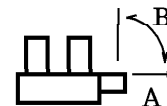

PRECAUTION

Please be careful of the followings.

- When installing, avoid to work by holding the connector by hand. Always, install by holding the main body of the element while assuring the mounting board is not warped or twisted. The connectors shall be inserted or pulled out at normal temperature.
- It is recommended to mount this product by inserting from the sheet metal pressed side.
- The container is made of polycarbonate. Polycarbonate is usually stable with acid, alcohol, and aliphatic hydrocarbons however, with pectochemicals (such as benzene, toluene, and acetone), alkali, aromatic hydrocarbons, or chloric hydrocarbons, polycarbonate becomes cracked, swollen, or melted. Please take care when chosing a packaging material by referencing the table below.

<Chemicals to avoid with polycarbonate>

	PHENOMENON	CHEMICALS
A	Little deterioration but staining	<ul style="list-style-type: none"> nitric acid (low concentration), hydrogen peroxide, chlorine
B	Cracked, crazed, or swollen	<ul style="list-style-type: none"> acetic acid (70% or more) gasoline methyl ethyl ketone, ehtyl acetate, butyl acetate ethyl methacrylate, ethyl ether, MEK acetone, m-amino alcohol, carbon tetrachloride carbon disulfide, trichloroethylene, cresol thinners, oil of turpentine triethanolamine, TCP, TBP
C	Melted { } : Used as solvent.	<ul style="list-style-type: none"> concentrated sulfuric acid benzene styrene, acrylonitrile, vinyl acetate ethylenediamine, diethylenediamine {chloroform, methyl chloride, tetrachloromethane, dioxane, } 1, 2-dichloroethane
D	Decomposed	<ul style="list-style-type: none"> ammonia water other alkali

RECOMMENDABLE MATCHED CONNECTOR
 Molex Japan Co., Ltd. made connector (Low profile type)

HOUSING	51004-0300				
TERMINAL	TYPE No.	PRODUCT FORM	MATERIAL	AWG SIZE	INSULATION DIAMETER
	50011-8100	LOOSEN	PHOSPHOR BRONZE	AWG24~30	1.4mm MAX
	50011-8000	LINKED			
	50031-8100	LOOSEN		AWG30~34	0.9mm MAX
50031-8000	LINKED				

For details of the connectors, please refer to the connector maker.

PRODUCT INDICATION

TYPE	ABBREVIATION
TLP1230 (C4)	P1230

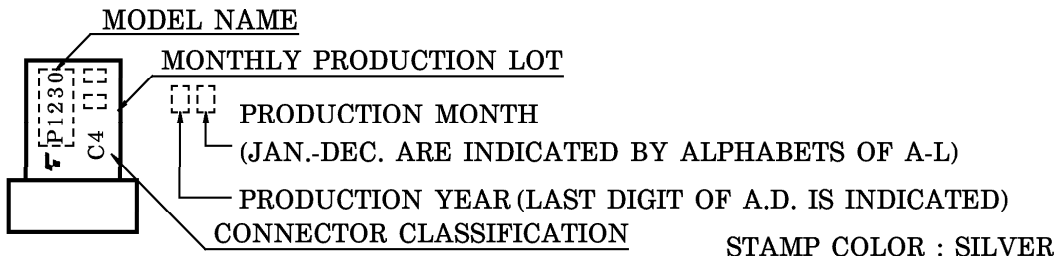

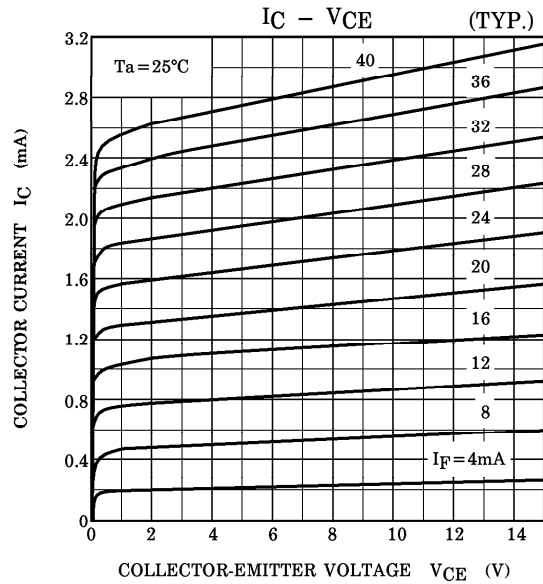
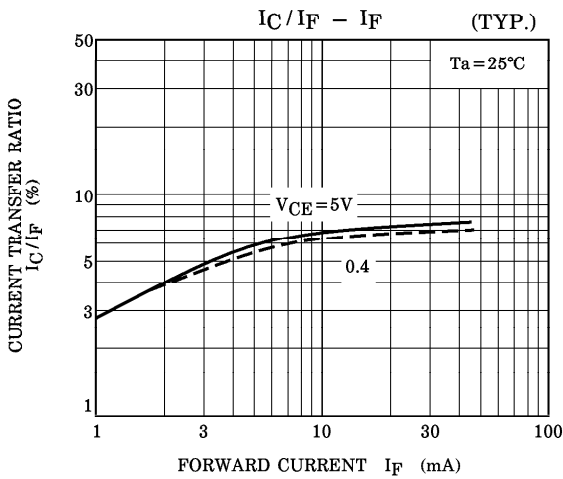
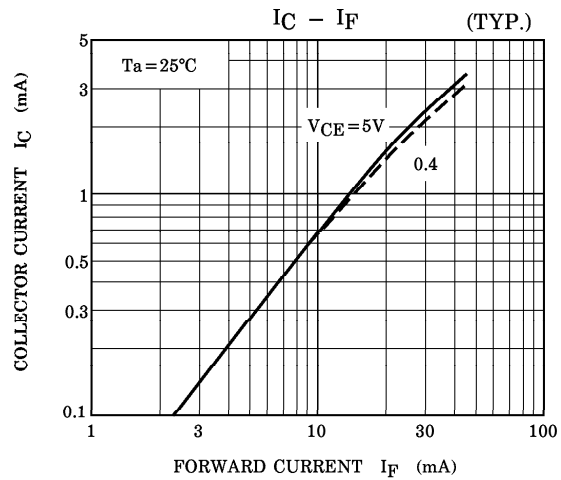
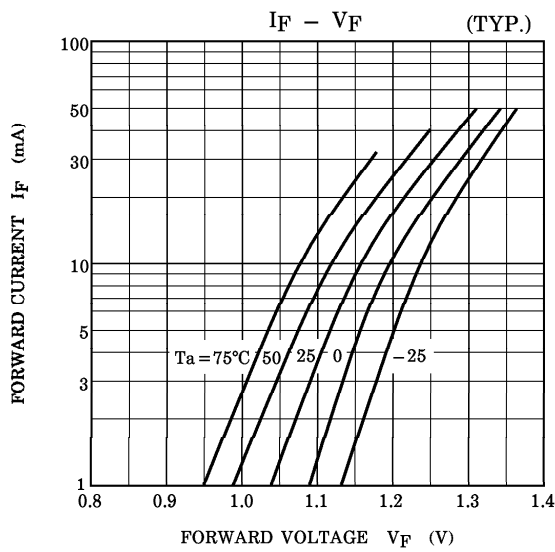
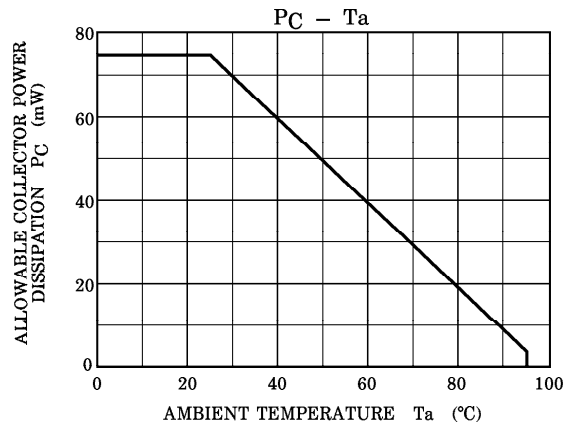
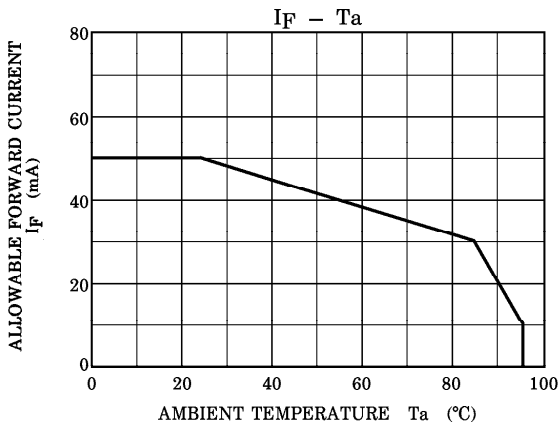

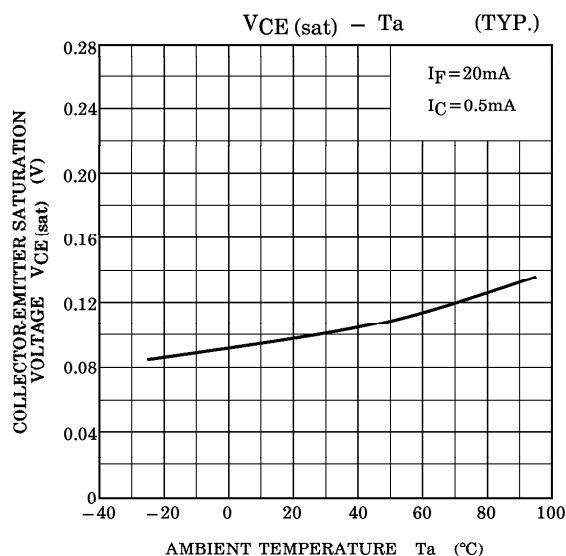
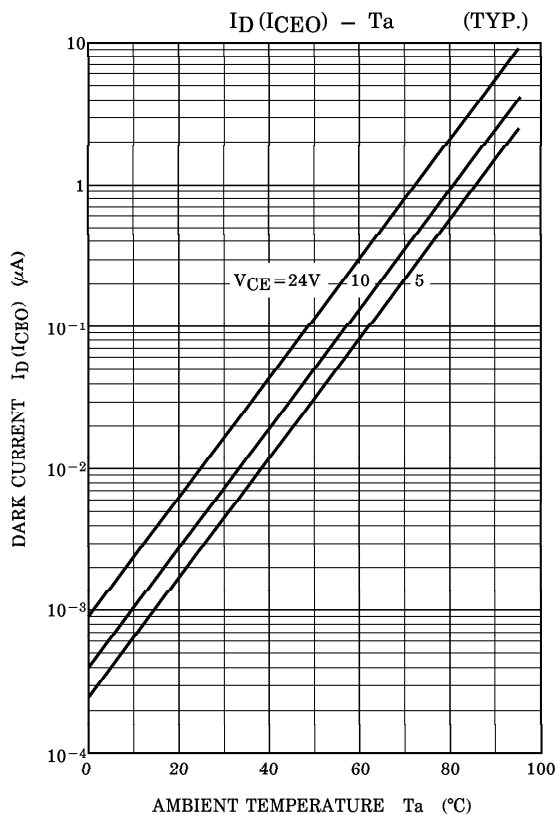
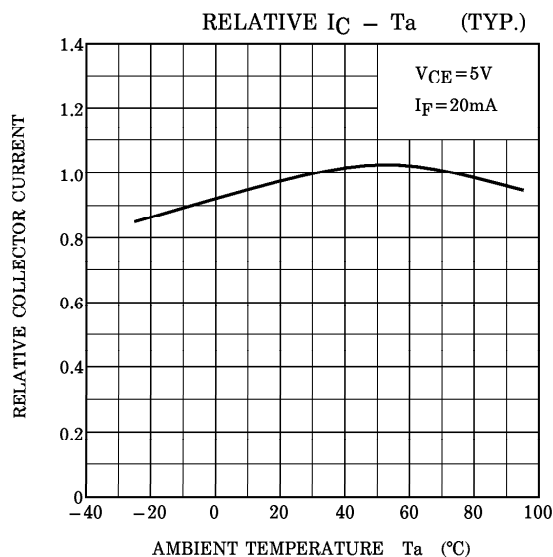
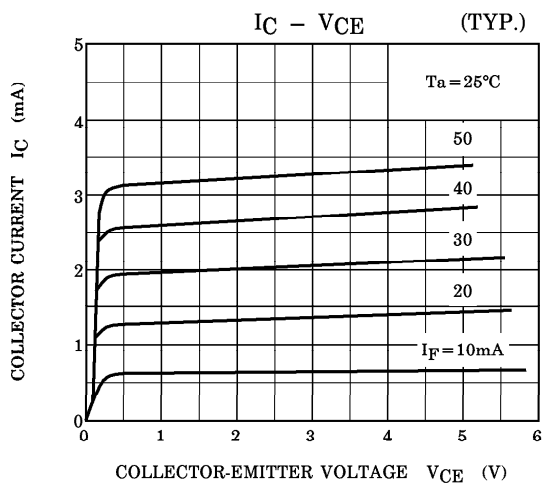

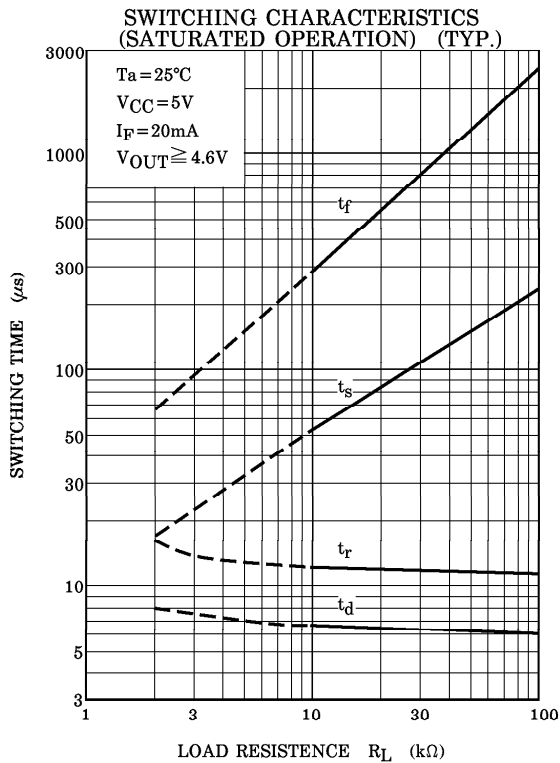
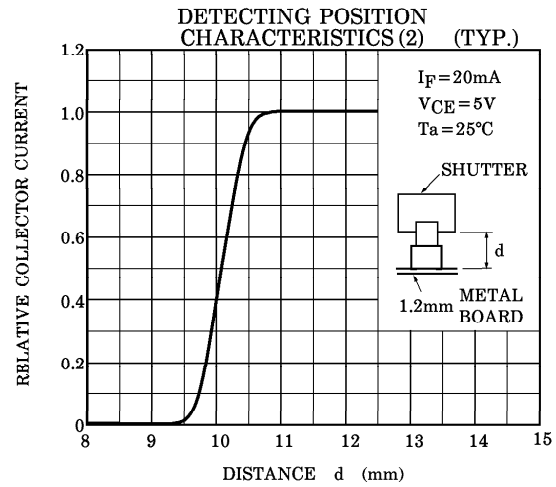
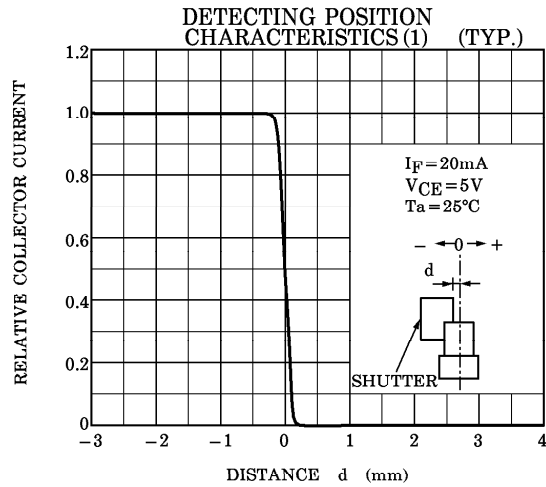
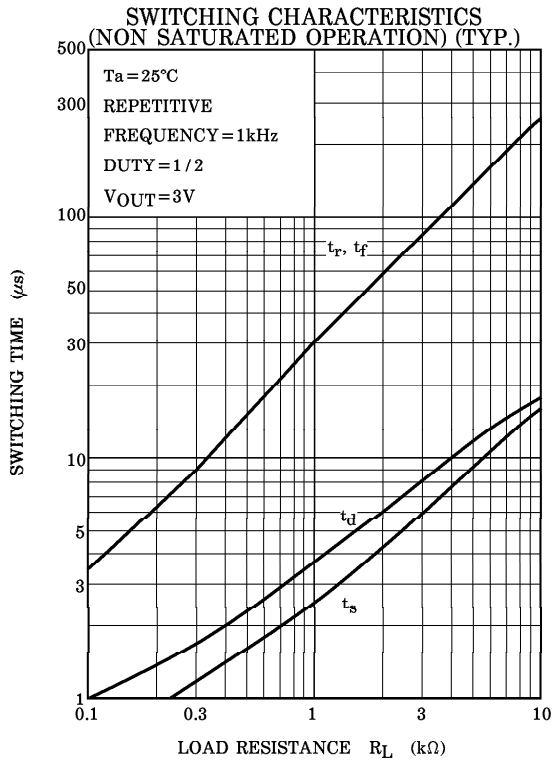

SWITCHING TIME TEST CIRCUIT

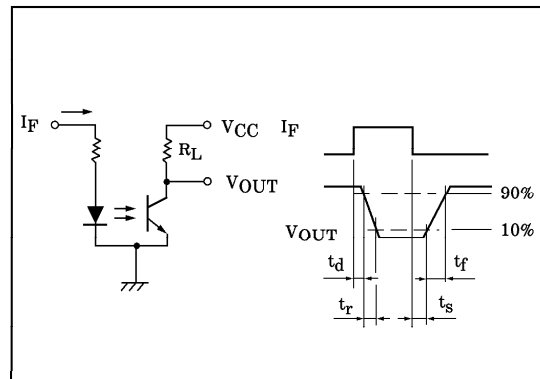

POSITIONING OF SHUTTER AND DEVICE

To operate correctly, make sure that the shutter and the device are positioned as shown in the figure below.

The slit pitch of the shutter must be set wider than the slit width of the device.
Determine the width taking the switching time into consideration.

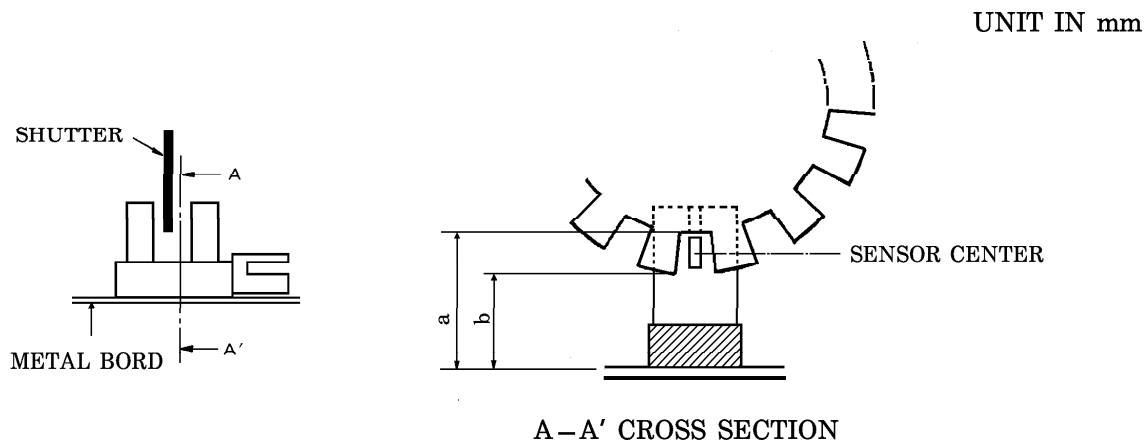

Unit : mm

METAL BOARD THICKNESS	a SIZE	b SIZE
1.0	11.9MIN.	9.4MAX.
1.2	11.7MIN.	9.2MAX.

RECOMMENDED MOUNTING HOLE

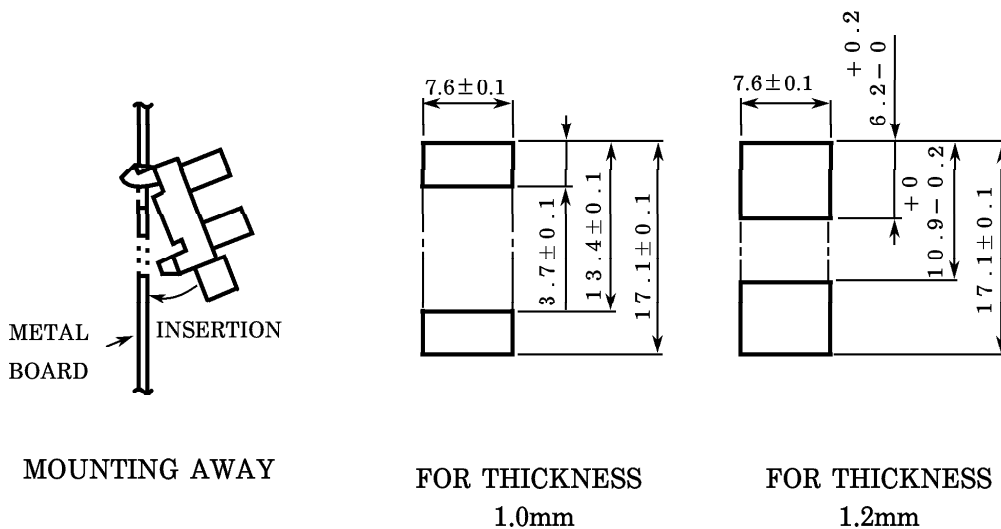

MOUNTING AWAY

FOR THICKNESS
1.0mm

FOR THICKNESS
1.2mm

This datasheet has been download from:

www.datasheetcatalog.com

Datasheets for electronics components.