

Interactive Catalog Supplements Catalog PDFs

If you need detailed product information, or help choosing the right product for your application, see our **Interactive Catalog**. Use the **Interactive Catalog** to access the most complete and up-to-date information available.

The **Interactive Catalog** provides an extensive collection of product specifications, application data, and technical literature that can be searched based on criteria you select.

This PDF catalog information was published in November 2000.



Sensing and Control
**Interactive
Catalog...**

**Click this icon to try
the Interactive Catalog.**

Sensing and Control

Honeywell Inc.

11 West Spring Street

Freeport, IL 61032



Applying Manual Controls and Displays

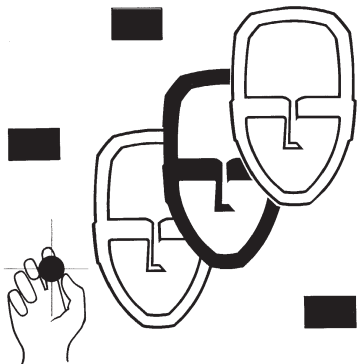

Adherence to good human factors principles can help your product make good first impressions as it is being evaluated by your customers; and increase long-term user satisfaction. You can gain a competitive edge that may translate into better acceptance by your customer and the user.

The panel, being the surface provided for display and control components, serves as the direct interface for human/machine dialogue. We'd like to offer the following guidelines to help you achieve ergonomically pleasing panels where communication flows operator-to-machine, and back again.

PREPARATION

Begin with procedures common to any design process. Prepare a list of the requirements related to the job to be performed. Then ask yourself such questions as:

- What is the panel (control station) to do?
- Who will be the users?
- Is there a special sequence of procedures to follow?
- Are there special environmental conditions or military requirements?
- Will the equipment be used inside or outside; in a shop, home or office?
- Will barriers, guards or protective shields be needed to safeguard components and/or users?
- Will the maintenance tasks be performed by the equipment user or a technician? How often and how easy to do?
- Who will install or set up the equipment?
- Are elaborate instructions required or can you design to make them unnecessary?
- What components are available?
- Will you do the specifying?
- What are the cost constraints?
- What elements should be added to estimate total installed cost?

Explore as many alternate means of achieving the desired results as possible. Then select the most effective combination of components. The earlier the foregoing questions are asked and answered in the concept or selection process, the more closely the panel design will match the requirements of a given application.

MATCH CONTROL TO FUNCTION

People expect controls to move in certain ways. Where possible, component selection should be an extension of normal habit patterns. For example, the wall-mounted toggle switch found in homes conveys a habit pattern for turning on lights. The upward flipping motion generally associated with "ON" can be used with other toggle, rocker and paddle switches for a natural transfer of a previously learned habit.

The clockwise motion of a rotary knob is frequently used to select an appliance function, such as the desired washer cycle. This same familiar action may be adapted to a control panel as an extension of a normal habit pattern.

When a panel uses control actions well-established in our daily lives:

- Reaction time is reduced.
- The first control movement by an operator is usually correct.
- An operator can perform faster, and can make adjustments with greater precision.
- An operator can learn control procedures faster.

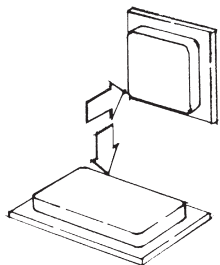

Pushbuttons (alternate-action or momentary)

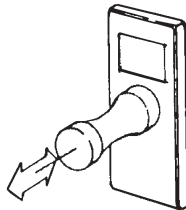

Push/pull switches

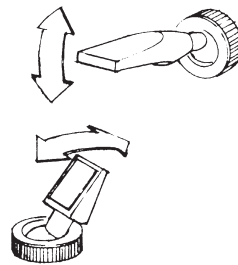

Toggles for 2- or 3-position select

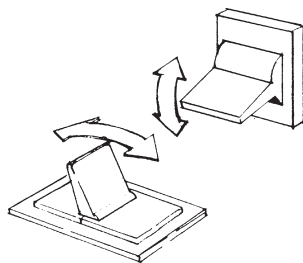

Paddles for 2- or 3-position select

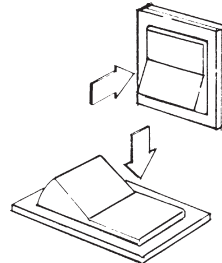

Rockers for 2- or 3-position select

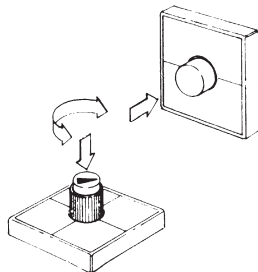

Pushbutton and rotary pushbutton/selector

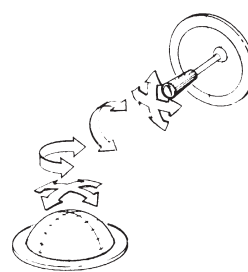

Trackball and joystick controls for 3-D maneuvering of CRT cursors in mapping or tracking tasks

Applying Manual Controls and Displays

COMPONENT ARRANGEMENT

Some control panels become overly complex because of the number and different types of components, or because the designer failed to explore enough alternative arrangements.

Before drawing the elements on a panel outline, it is helpful to make paper cutouts of the separate switches, indicators, etc. These cutouts can be easily shifted into various groups, and relationships until the most effective arrangement is found. You will save hours of tedious drawing, erasing and redrawing, and should achieve a better layout. Also, you are more likely to resist the temptation to stop looking for the optimal solution too early in the design process.

Here are some suggestions for good arrangement:

1. Frequently used components should be the most accessible.
 - for manually operated controls, somewhere between elbow and shoulder height.
 - for displays, nearest the normal line of sight.
2. Arrange controls and displays for a conventional sequence of operation, left-to-right and top-to-bottom, just as we normally read.
3. Define functional areas by leaving space between component groups. Avoid outline borders, color patches and brackets extending from group titles (except in cases of extreme density.)
4. Locate emergency controls and displays prominently on the panel to assure easy viewing and access by the operator.
5. Where large layouts are necessary, distribute the workload between both hands of the operator — for ease of operation and increased productivity.
6. Locate displays above (preferable) or to the left of corresponding manual controls to prevent visual interference while the manual controls are being operated. (When manual controls are at the extreme left of a panel, displays should be above the controls.)

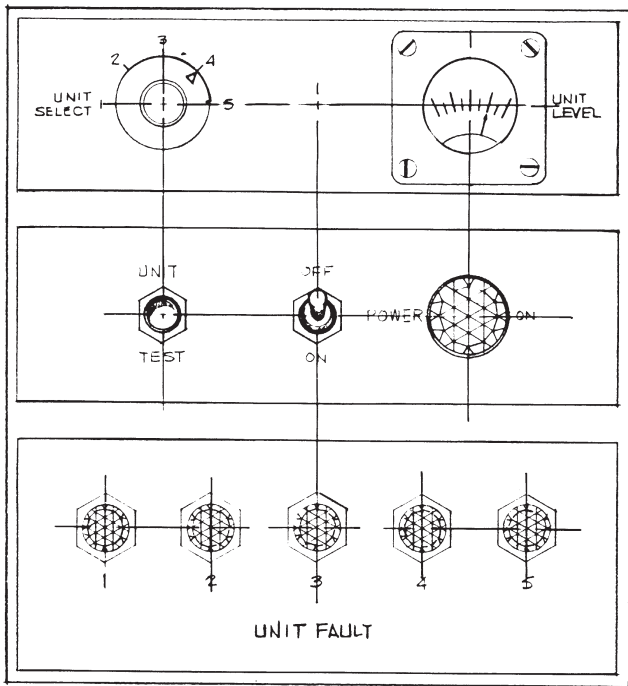

Poor

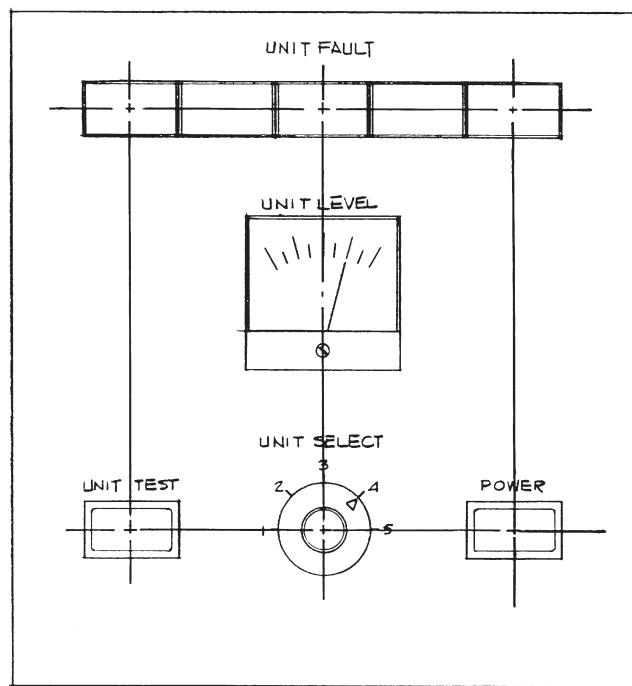

Preferred

Alternative panel layouts. These before-and-after views illustrate how an existing design may be upgraded to better communicate through layout revision and component substitution. Both function and appearance are improved.

For example, the left hand panel uses outline frames to unnecessarily separate related functions. The frames serve merely as a decorative feature and contribute to a crowded look. In the right hand panel, the frames are eliminated, as the components themselves define their functional space.

The uniform use of square and rectangular panel elements in the right hand panel serves to further simplify and harmonize the appearance. Note that the UNIT FAULT indicators and the analog meter are located in the top half of the panel to help prevent the operator's hand from obscuring them when the controls are being used. The POWER switch-indicator combination eliminates the separate POWER ON light. Also, legends appear above their respective components, rather than in the left hand version's random arrangement.

Applying Manual Controls and Displays

GRAPHICS CONSIDERATIONS

Panel graphics need not overwhelm the operator with their size, since they are normally viewed at about arm's length.

Legibility is reinforced when the color chosen for the graphics contrasts strongly with the background. Type is most legible when it is shown as dark lettering on a light panel.

Panel Titles

Titles applied to the panel itself should normally appear above the controls to prevent them from being obscured when a control is in use. An exception would be when panel components must be placed at a height that would block the operator's line of sight to the title.

If different-sized components are used in a horizontal array, pick a common baseline for all their associated titles to avoid a stepped, disorderly look.

Whenever possible, apply graphics directly on the manual controls or lighted indicators themselves. This not only conserves valuable panel space, but enhances overall design flexibility. Recommended graphic colors for component surfaces are white on red, green, and blue; black on yellow and white; and white or black on amber.

Alphanumeric and symbol legends can be added or easily changed merely by replacing a switch or indicator button, lens, or rocker-button operator.

Type Selection. All titles should be composed of a simple sans serif typeface for optimum clarity (see examples, at right). Lettering should be horizontal, never vertical. Type sizes should conform to panel component priorities (refer to typical letter heights for titles in descending order, as shown on page 140).

Avoid abbreviations whenever possible; spell out the entire word. If horizontal space is tight, try condensed type, but use it consistently, not interspersed with a standard width type. Inconsistent use of the type styles, sizes, or line weights add visual "noise" to the overall panel scheme and should be avoided.

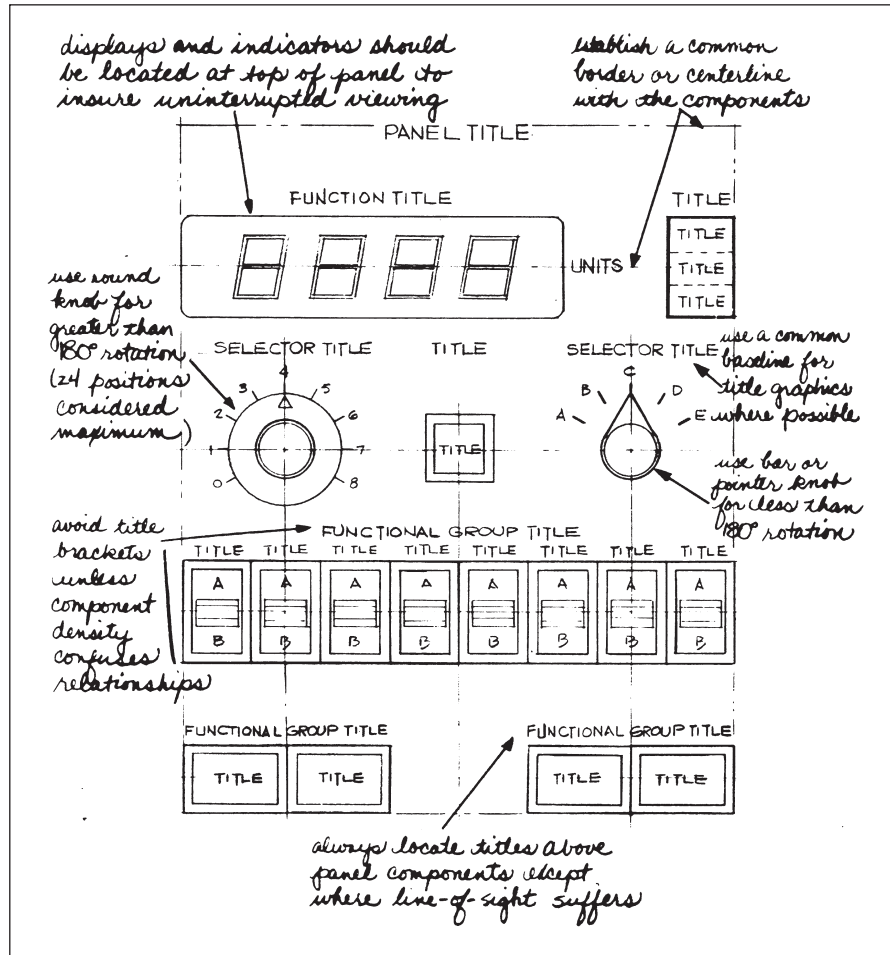

Layout and graphic design considerations

Typeface Examples

Helvetica Medium (This is the preferred type proportion and weight for most titles).

ABCDEFGHIJKLMNOPQRSTUVWXYZ
1234567890

Helvetica Medium Condensed

ABCDEFGHIJKLMNOPQRSTUVWXYZ
1234567890

Helvetica Bold

ABCDEFGHIJKLMNOPQRSTUVWXYZ
1234567890

Applying Manual Controls and Displays

Strip barriers between switches help to prevent inadvertent operation.

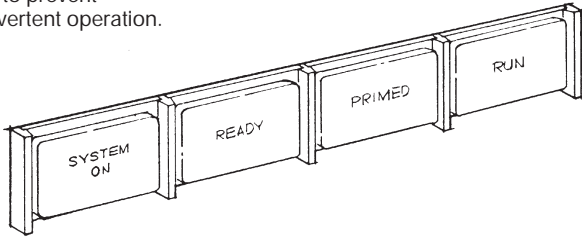

Full barriers surround pushbuttons where more switch protection is desired.

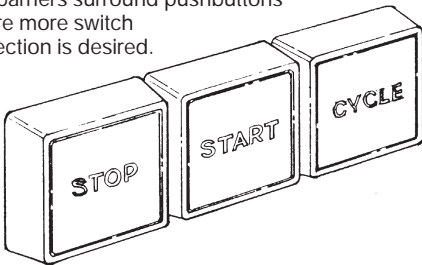

Hinged guards over pushbuttons in high risk control situations. Guards may also be locked for additional security.

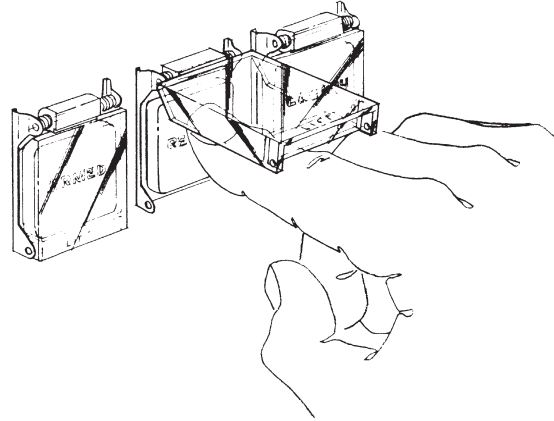

ILLUMINATED COLOR TECHNIQUES

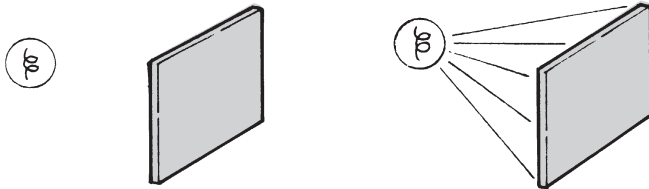

Transmitted color achieved with colored lens (color is visible even when display is unlighted).

Transmitted color refers to the use of colored buttons in applications when the color must be apparent when the display is lighted or unlighted.

Projected color is achieved with a white lens and a color filter/lens. When the lamps are off, the display is white. It becomes colored when illuminated. Though effective in dimly lit or dark rooms, the color signal tends to weaken in high ambient light.

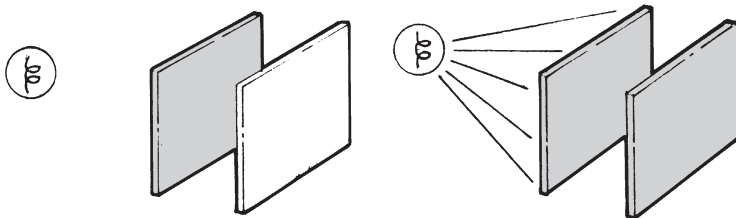

Projected color achieved with colored filter behind white lens (color not visible until lamp is lighted).

Dead front is a hidden legend/color display which generally uses a transparent, smoky gray lens with a legend on a color insert. The display appears black and unobtrusive when the lamps are off. When illuminated, color and legend appear.

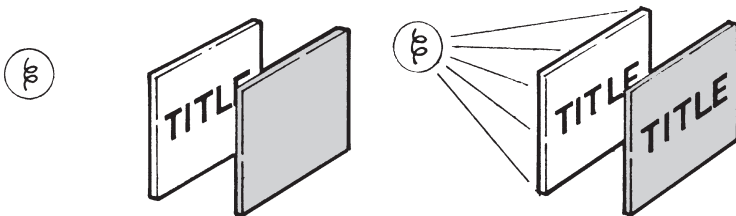

Hidden legend/hidden color (dead front). Dark lens hides color/message until display is lighted.

Applying Manual Controls and Displays

TYPE SIZES

The type sizes chosen should always correspond to the functional priorities of the control panel components, in a descending order, e.g., Panel Title, Group Title, Station Title. Individual application requirements may vary, but grossly oversized letters should be avoided (see drawing).

COLOR CODING

Follow accepted human factor standards when you color code interface components. Since many colors relate to certain well established meanings, e.g., red for STOP, green for GO, they should be used wherever appropriate.

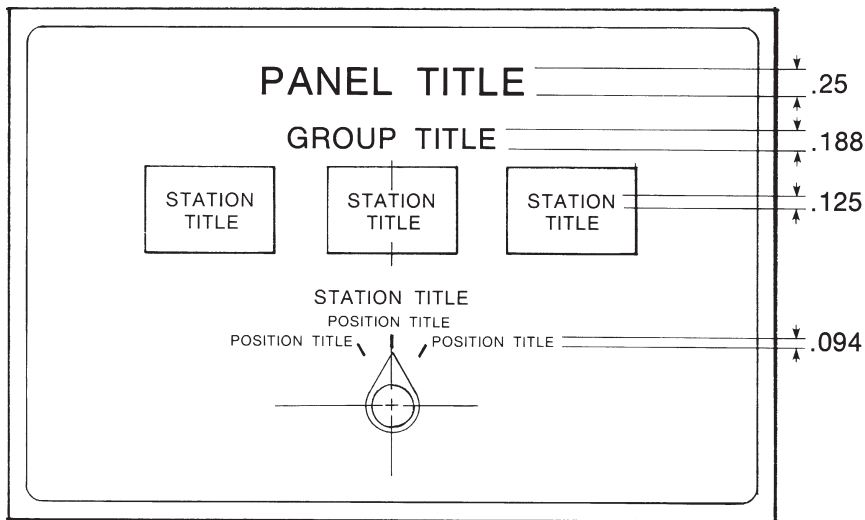

Color	Meanings	Examples
Red	Alerts an operator that an incompatible or dangerous condition exists and corrective action should be taken.	Stop, No-go, Error, Failure, Malfunction, Danger, Warning, Hazard, Take Cover
Yellow	Marginal condition exists	Pressure Below Normal, Check Hopper Level, Caution, Inspection Port Open
Green	Monitored equipment is in tolerance, or a condition is satisfactory and it is all right to proceed	On, Power On,* Go-ahead, Safe, Ready
Blue	May use as an advisory indicator, but has limited coding value; however blue is ideally suited for use at periphery of vision where it can be apparent, but not intrusive	High Beam (automobile headlights)
White	Indicates system conditions or transitions, neither positive nor negative; doesn't imply success or failure	Boiler #1 On Line, Reservoir Cycling

* Note: The power generating industry is an exception, since it traditionally has used the color red to indicate Power On. Their rationale is that red connotes a "hot" electrical condition. However, green is definitely the preferred human factors choice for Power On indication.

PANEL FINISH

Non-reflecting, matte-textured colors from light gray to black, beige, and white will yield a panel that contrasts well with controls and indicators of any color. Neutral color backgrounds will focus attention on the controls. But color effectiveness is muted when interface components are surrounded by a panel of a like or similar color.

When in doubt, keep it simple and in good taste – and you will achieve the most satisfying, long-term results.

FINAL EVALUATION

Prior to finalizing your design, evaluate the total panel layout experimentally. Assess its communication effectiveness with a test situation, using a mock-up or prototype. Describe the application to typical operators, individually.

Observe the procedures used by the operators. If there are basic design errors, they should show up, along with the operator's preferences for certain control features. Separate individual prejudices from valid criticisms. Then apply the data to a revised layout. Check and recheck.

In actual practice, there are normally several revisions made beyond an initial proposal. Rarely, if ever, does the first scheme prove acceptable as the final design; so don't be disheartened when new insights from associates or test results necessitate change. Even after a design goes into production, it is not unusual for revisions to be made because of undiscovered problems.