

# OEM Relative and absolute pressure transmitter type 501

Pressure ranges  
-1 ... 0 – 60 bar

Type 501 pressure transmitters, with partially automated production processes, are suitable for larger quantity industrial OEM applications.

Various pressure and electrical connections, together with several standardised output signals, provide suitability for a wide variety of applications.

- Compact construction
- Automated manufacture in large quantities for ideal price / performance ratio
- Robust ceramic sensor technology
- High resistance to extreme temperatures
- No mechanical creepage



**Technical overview****Pressure range**

Relative	-1 ... 0 – 60 bar
Absolute	0 ... 2.5 – 16 bar

**Operating conditions**

Medium		Liquids and gases
Temperature	Medium / ambient	-15 ... +80 °C
	Storage	-40 ... +80 °C
Tolerable overload		2 x fs (max. 80 bar)
Repture pressure		3 x fs (max. 90 bar)

**Materials**

Case		PA6
Materials in contact with the medium	Sensor	Ceramic Al <sub>2</sub> O <sub>3</sub> (96%)
	Pressure connection	Stainless steel 1.4305 / AISI 303
	Sealing material	FPM, EPDM, NBR, MVQ

**Electrical overview**

	Output	Power supply	Load	Current consumption <sup>1)</sup>
2 wire	4 ... 20 mA	8.0 ... 33 VDC	$< \frac{\text{Supply voltage} - 8 \text{ V}}{0.02 \text{ A}}$ [Ohm]	< 20 mA
	4 ... 20 mA	10.0 ... 33 VDC	$< \frac{\text{Supply voltage} - 10 \text{ V}}{0.02 \text{ A}}$ [Ohm]	< 20 mA
3 wire	0 ... 5 V	9.0 ... 33 VDC	> 10 kOhm / < 100 nF	< 5 mA
	1 ... 6 V	10.4 ... 33 VDC	> 10 kOhm / < 100 nF	< 5 mA
	0 ... 10 V	16.2 ... 33 VDC	> 10 kOhm / < 100 nF	< 6 mA
	ratiom. 10 ... 90%	5 VDC ±5%	> 10 kOhm / < 100 nF	< 3 mA
Polarity reversal protection	Short circuit proof and protected against polarity reversal. Each connection is protected against crossover up to max. supply voltage.			

**Dynamic response**

Response time	< 5 ms
Load cycle	< 50 Hz

**Protection standard**

IP 65
-------

**Electrical connection**

Cable 1.5 m
Connector DIN EN 175301-803-A
Connector DIN EN 175301-803-C (mini DIN)
Connector M12x1

**Pressure connection**

Inside thread	G ¼ mit O-Ring sealing
	¼ -18 NPT
Outside thread	G ¼, sealed at back, DIN 3852 form E
	R ¼ DIN 2999
	G ¼, sealed at back and manometer (combi)
	G ½, sealed at back and manometer (combi)

**Installation arrangement**

Recommended: Pressure connection downwards
--

**Tests / Admissions**

Electromagnetic compatibility	CE conformity acc. EN 61326-2-3
-------------------------------	---------------------------------

**Weight**

With inside thread	~ 95 g
With outside thread	~ 110 g
With cable 1.5 m additional	~ 40 g

**Packaging (Please state on order)**

Single packaging in cardboard
Multiple packaging in cardboard per 25 pcs.

**Accuracy**

Parameter		Unite	
Tolerance zero point	max.	% fs	± 1.0
Tolerance full scale	max.	% fs	± 1.0
Resolution		% fs	0.1
Total of linearity, hysteresis and repeatability	max.	% fs	± 0.5
Long term stability acc. to DIN EN 60770		% fs	± 1.0
TC zero point <sup>2)</sup>	max.	% fs/10K	± 0.4
TC sensitivity <sup>2)</sup>	typ.	% fs/10K	- 0.15
TC sensitivity <sup>2)</sup>	max.	% fs/10K	- 0.3

Test conditions: 25 °C, 45% RH, power supply 24 VDC  
TC z.p. / TC s. -40 ... +80 °C

<sup>1)</sup> At nominal pressure

Order code selection table		501. X X X X X X X X X X X X											
Pressure mode	Relative	9											
	Absolute	8											
Pressure range	-1 ... 0 bar	9	0	0									
	0 ... 1 bar	9	1	1									
	0 ... 1.6 bar	9	1	2									
	0 ... 2.5 bar		1	4									
	0 ... 4 bar		1	5									
	0 ... 6 bar		1	7									
	0 ... 10 bar		3	0									
	0 ... 16 bar		3	1									
	0 ... 25 bar	9	3	2									
	0 ... 40 bar	9	3	3									
0 ... 60 bar	9	4	0										
▲ Full scale signale at these pressures													
Sealing material <sup>1)</sup>	FPM Fluoro elastomer											0	
	EPDM Ethylene propylene											1	
	NBR Butadiene Aclylonitrile											2	
	MVQ Silicone polymer											3	
Adjustment	Factory											0	
Output / power supply	0 ... 5 V	9.0 ... 33 VDC											1
	1 ... 6 V	10.4 ... 33 VDC											6
	0 ... 10 V	16.2 ... 33 VDC											2
	4 ... 20 mA	10.0 ... 33 VDC											3
	4 ... 20 mA	8.0 ... 33 VDC											8
	ration. 10 ... 90%	5 VDC ±5%											4
Electrical connection	Cable 1.5 m												0
	Connector <sup>2)</sup> DIN EN 175301-803-A												1
	Connector <sup>2)</sup> DIN EN 175301-803-C (mini DIN)												2
	Connector <sup>2)</sup> M12x1 plastic thread												3
Pressure connection	Inside thread	G ¼ with O-Ring seal											1
	Outside thread	¼ - 18 NPT											3
	Outside thread	G ¼ sealed at back, DIN 3852 form E											4
	Outside thread	R ¼ DIN 2999											7
	Outside thread	G ¼, sealed at back and manometer (combi)											5
	Outside thread	G ½, sealed at back and manometer (combi)											8
Pressure tip orifice	Without												1
	With												2
Pressure range variation	Indicate W and state range on order (e.g.: W0... + 9bar/OUT1...9V)											W	

### Storage versions

Output	4 ... 20 mA	Pressure range	Order number
Power supply	10 ... 33 VDC	-1 ... 0 bar	501.914023151W - 1...0 bar (high overload protection)
Electrical connection <sup>2)</sup>	Connector DIN EN 175301-803-A, IP 65	0 ... 10 bar	501.930023151
Pressure connection	G¼ sealed at back and manometer	0 ... 25 bar	501.932023151
Sealing material	FPM Fluoro-elastomer		
Colour of cover	black		

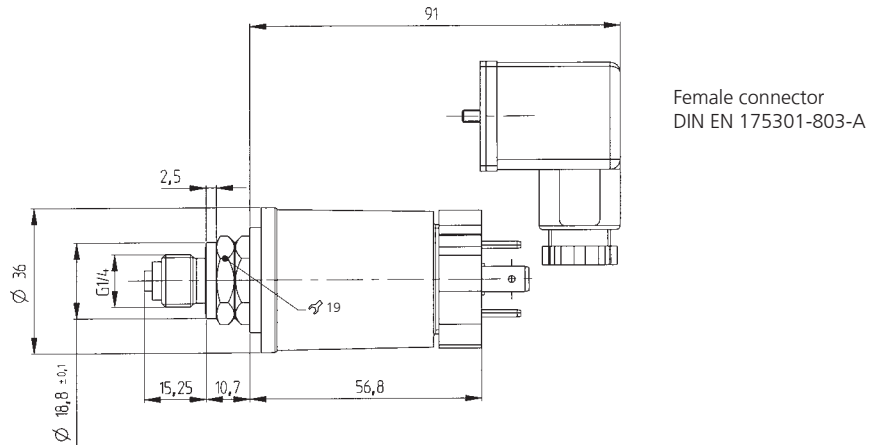

### Accessories <sup>3)</sup>

Female connector DIN EN 175301-803-A	with seal (IP 65, when installed and latched)	Order number	103510
Female connector DIN EN 175301-803-C (mini DIN)	with seal (IP 65, when installed and latched)		104244
Female connector M12x1			106975
Calibration certificate			104551

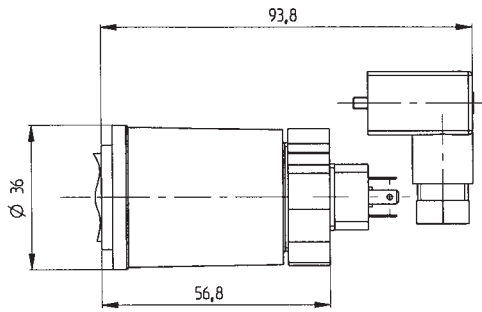
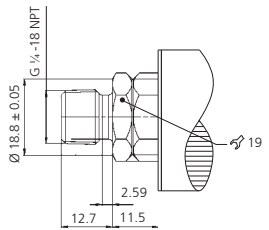
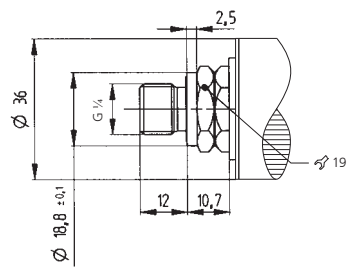
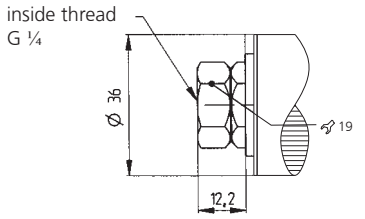

Female connector  
DIN EN 175301-803-C

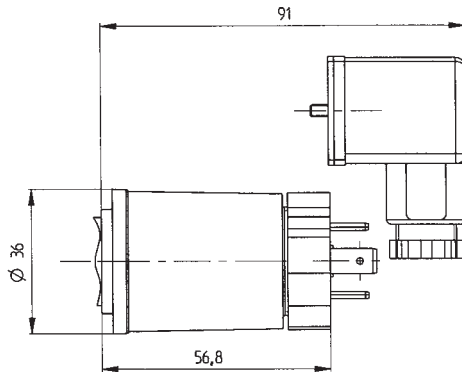

Female connector  
DIN EN 175301-803-A

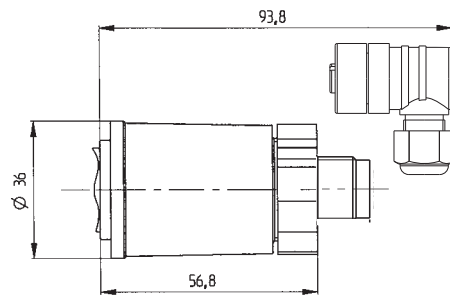
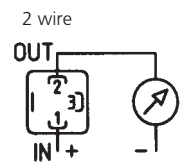
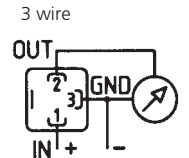

Female connector  
M12x1

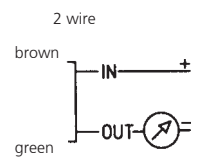
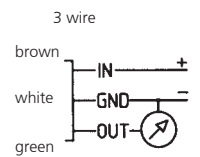
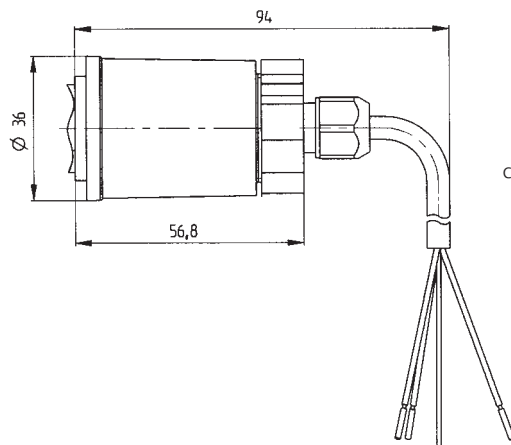
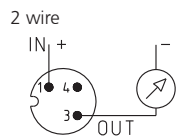
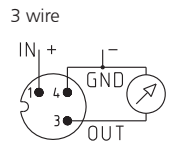

# Huba Control

FOR FINE PRESSURE AND FLOW MEASUREMENT

**Huba Control AG**  
**Headquarters**

Industriestrasse 17  
5436 Würenlos  
Telefon +41 (0) 56 436 82 00  
Telefax +41 (0) 56 436 82 82  
[info.ch@hubacontrol.com](mailto:info.ch@hubacontrol.com)

**Huba Control AG**  
**Niederlassung Deutschland**

Schlattgrabenstrasse 24  
72141 Walddorfhäslach  
Telefon +49 (0) 7127 23 93 00  
Telefax +49 (0) 7127 23 93 20  
[info.de@hubacontrol.com](mailto:info.de@hubacontrol.com)

**Huba Control SA**  
**Succursale France**

Rue Lavoisier  
Technopôle Forbach-Sud  
57602 Forbach Cedex  
Téléphone +33 (0) 387 847 300  
Télécopieur +33 (0) 387 847 301  
[info.fr@hubacontrol.com](mailto:info.fr@hubacontrol.com)

**Huba Control AG**  
**Vestiging Nederland**

Hamseweg 20A  
3828 AD Hoogland  
Telefoon +31 (0) 33 433 03 66  
Telefax +31 (0) 33 433 03 77  
[info.nl@hubacontrol.com](mailto:info.nl@hubacontrol.com)

**Huba Control AG**  
**Branch Office United Kingdom**

Unit 13 Berkshire House  
County Park Business Centre  
Shrivenham Road  
Swindon - Wiltshire SN1 2NR  
Phone +44 (0) 1993 776667  
Fax +44 (0) 1993 776671  
[info.uk@hubacontrol.com](mailto:info.uk@hubacontrol.com)

[www.hubacontrol.com](http://www.hubacontrol.com)