

Subminiature Basic Switch

SS

Subminiature Basic Switch Offers Long Life of 30,000,000 Operations

- A design that combines simplicity and stability by the use of two split springs ensures a long service life of 30,000,000 operations.
- A variety of models are available, with operating force ranging from low to high.
- Solder, quick-connect terminals (#110) and PCB terminals are available.
- Approval obtained for standards including UL, CSA, and VDE.



Ordering Information

Model Number Legend

SS-□□□□□
1 2 3 4 5

1. Ratings

01: 0.1 A at 125 VAC
5: 5 A at 125 VAC
10: 10 A at 125 VAC

2. Actuator

None: Pin plunger
GL: Hinge lever
GL13: Simulated roller lever
GL2: Hinge roller lever

3. Operating Force (at Pin Plunger)

None: 1.47 N {150 gf}
-F: 0.49 N {50 gf} (0.1 A, 5 A)
-E: 0.25 N {25 gf} (0.1 A)

Note: These values are for the pin plunger model.

4. Contact Form

None: SPDT
-2: SPST-NC
-3: SPST-NO

5. Terminals

None: Solder
T: Quick-connect terminals (#110)
D: PCB

Note: The PCB terminal has a right-angle terminal option.
D1: Left-angle terminal
D2: Right-angle terminal

Note: When suffix "-T" is placed after the model number, the model withstands high temperatures (-25°C to 120°C).

Contact Form

SPDT

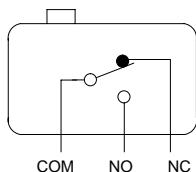



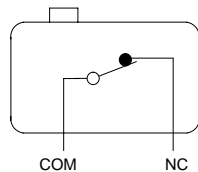



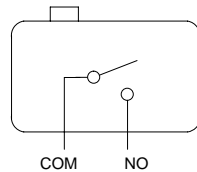





SPST-NC



SPST-NO



■ List of Models

Rating	Actuator	OF max.	Solder terminal	Quick-connect terminal (#110)	PCB terminal	
0.1 A	Pin plunger 	0.25 N {25 gf}	SS-01-E	SS-01-ET	SS-01-ED	
		0.49 N {50 gf}	SS-01-F	SS-01-FT	SS-01-FD	
		1.47 N {150 gf}	SS-01	SS-01T	SS-01D	
	Hinge lever 	0.08 N {8 gf}	SS-01GL-E	SS-01GL-ET	SS-01GL-ED	
		0.16 N {16 gf}	SS-01GL-F	SS-01GL-FT	SS-01GL-FD	
		0.49 N {50 gf}	SS-01GL	SS-01GLT	SS-01GLD	
	Simulated roller lever 	0.08 N {8 gf}	SS-01GL13-E	SS-01GL13-ET	SS-01GL13-ED	
		0.16 N {16 gf}	SS-01GL13-F	SS-01GL13-FT	SS-01GL13-FD	
		0.49 N {50 gf}	SS-01GL13	SS-01GL13T	SS-01GL13D	
	Hinge roller lever 	0.08 N {8 gf}	SS-01GL2-E	SS-01GL2-ET	SS-01GL2-ED	
		0.16 N {16 gf}	SS-01GL2-F	SS-01GL2-FT	SS-01GL2-FD	
		0.49 N {50 gf}	SS-01GL2	SS-01GL2T	SS-01GL2D	
5 A	Pin plunger 	0.49 N {50 gf}	SS-5-F	SS-5-FT	SS-5-FD	
		1.47 N {150 gf}	SS-5	SS-5T	SS-5D	
	Hinge lever 	0.16 N {16 gf}	SS-5GL-F	SS-5GL-FT	SS-5GL-FD	
		0.49 N {50 gf}	SS-5GL	SS-5GLT	SS-5GLD	
	Simulated roller lever 	0.16 N {16 gf}	SS-5GL13-F	SS-5GL13-FT	SS-5GL13-FD	
		0.49 N {50 gf}	SS-5GL13	SS-5GL13T	SS-5GL13D	
	Hinge roller lever 	0.16 N {16 gf}	SS-5GL2-F	SS-5GL2-FT	SS-5GL2-FD	
		0.49 N {50 gf}	SS-5GL2	SS-5GL2T	SS-5GL2D	
	10.1 A	Pin plunger 	1.47 N {150 gf}	SS-10	SS-10T	SS-10D
		Hinge lever 	0.49 N {50 gf}	SS-10GL	SS-10GLT	SS-10GLD
Simulated roller lever 		0.49 N {50 gf}	SS-10GL13	SS-10GL13T	SS-10GL13D	
Hinge roller lever 		0.49 N {50 gf}	SS-10GL2	SS-10GL2T	SS-10GL2D	

Note: Contact your OMRON representative for details on SPST-NO and SPST-NC models.

Specifications

■ Ratings

Type	Rated voltage	SS-10, SS-5								SS-01	
		Non-inductive load				Inductive load				Non-inductive load	
		Resistive load		Lamp load		Inductive load		Motor load		Resistive load	
		NC	NO	NC	NO	NC	NO	NC	NO	NC	NO
General-purpose	125 VAC	5 (10.1) A (see note 1)		1.5 A	0.7 A	3 A		2.5 A	1.3 A	0.1 A	
	250 VAC	3 (10.1) A (see note 1)		1 A	0.5 A	2 A		1.5 A	0.8 A	---	
	8 VDC	5 (10.1) A (see note 1)		2 A		5 A	4 A	3 A		0.1 A	
	14 VDC	5 (10.1) A (see note 1)		2 A		4 A	4 A	3 A		0.1 A	
	30 VDC	4 A		2 A		3 A	3 A	3 A		0.1 A	
	125 VDC	0.4 A		0.05 A		0.4 A	0.4 A	0.05 A		---	
	250 VDC	0.2 A		0.03 A		0.2 A	0.2 A	0.03 A		---	

- Note:**
1. Data in parentheses apply to the SS-10 models only.
 2. The above values are for the steady-state current.
 3. Inductive load has a power factor of 0.4 min. (AC) and a time constant of 7 ms max. (DC). The inductive load rating of SS-10 is the same as that of SS-5.
 4. Lamp load has an inrush current of 10 times the steady-state current.
 5. Motor load has an inrush current of 6 times the steady-state current.
 6. If the Switch is used in a DC circuit and is subjected to a surge, connect a surge suppressor across the Switch.
 7. The ratings values apply under the following test conditions:
 Ambient temperature: 20±2°C
 Ambient humidity: 65±5%
 Operating frequency: 30 operations/min

■ Characteristics

Operating speed	0.1 mm to 1 m/s (pin plunger models)
Operating frequency	Mechanical: 400 operations/min Electrical: 60 operations/min
Insulation resistance	100 MΩ min. (at 500 VDC)
Contact resistance (initial value)	OF 1.47 N {150 gf}: SS-01 models: 50 mΩ max. SS-5, SS-10 models: 30 mΩ max. OF 0.49 N {50 gf}: SS-01 models: 100 mΩ max. SS-5 models: 50 mΩ max. OF 0.25 N {25 gf}: SS-01 models: 150 mΩ max.
Dielectric strength	1,000 VAC (600 VAC for SS-01 models), 50/60 Hz for 1 min between terminals of the same polarities 1,500 VAC, 50/60 Hz for 1 min between current-carrying metal part and ground, and between each terminal and non-current-carrying metal part (see note 1)
Vibration resistance (see note 2)	Malfunction: 10 to 55 Hz, 1.5-mm double amplitude
Shock resistance	Destruction: OF 1.47 N {150 gf}: 1,000 m/s ² {approx. 100G} max. OF 0.25 N {25gf}/0.49 N {50 gf}: 500 m/s ² {approx. 50G} max. Malfunction: OF 1.47 N {150 gf}: 300 m/s ² {approx. 30G} max. OF 0.25 N {25 gf}/0.49 N {50 gf}: 200 m/s ² {approx. 20G} max. Note: Lever-type model: Total travel position (with a contact separation time of 1 ms max.)
Life expectancy	Mechanical: 30,000,000 operations min. (Refer to the following <i>Engineering Data</i> .) 10,000,000 operations min. for SS-10 models Electrical: 200,000 operations min. (Refer to the following <i>Engineering Data</i> .) 50,000 operations min. for SS-10 models
Degree of protection	IP00
Degree of protection against electrical shock	Class 1
Proof Tracking Index (PTI)	175
Ambient temperature	Operating: -25°C to 85°C (at ambient humidity of 60% max.) (with no icing)
Ambient humidity	Operating: 85% max. (for 5°C to 35°C)
Weight	Approx. 1.6 g (pin plunger models)

Note: 1. The dielectric strength shown in the table indicates a value for models with a Separator.

2. For the pin plunger models, the above values apply for use at both the free position and total travel position. For the lever models, they apply at the total travel position.

■ Approved Standards

UL/CSA

Rated voltage	SS-10	SS-5	SS-01
125 VAC	---	5 A	0.1 A
250 VAC	10.1 A	3 A	---
30 VDC	---	---	0.1 A

VDE (EN61058-1)

Rated voltage	SS-10	SS-5
250 VAC	10 A	5 A

TÜV Rheinland (EN61058-1)

Rated voltage	SS-10	SS-5
250 VAC	10 A	5 A/5 (1) A

Note: Test conditions: 50,000 operations; T85 (0 to 85°C).

■ Contact Specifications

Item		SS-10	SS-5	SS-01
Contact	Specification	Rivet		Crossbar
	Material	Silver alloy	Silver	Gold alloy
	Gap (standard value)	0.5 mm		0.25 mm
Inrush current	NC	20 A max.		1 A max.
	NO	15 A max.	10 A max.	1 A max.
Minimum applicable load		160 mA at 5 VDC		1 mA at 5 VDC

Engineering Data

Mechanical Life Expectancy (Pin Plunger Model)

SS-5, SS-1, SS-01 Models

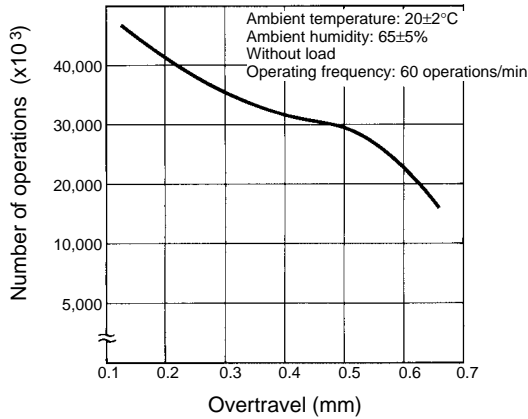

Electrical Life Expectancy (Pin Plunger Model)

SS-5 Models

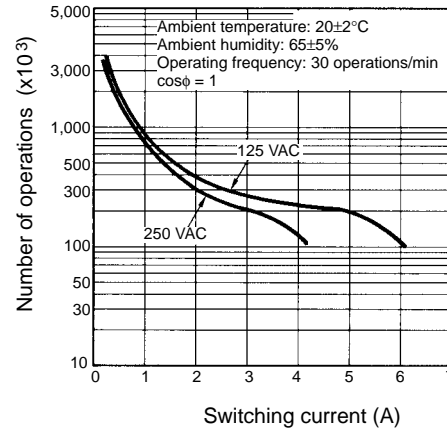

Dimensions

Note: All units are in millimeters unless otherwise indicated.

Terminals

Terminal plate thickness is 0.5 mm.

Solder Terminal

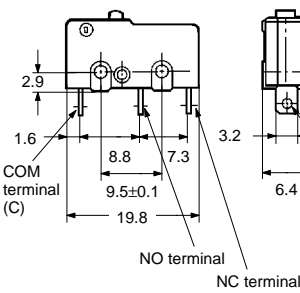

Quick-connect Terminal (#110)

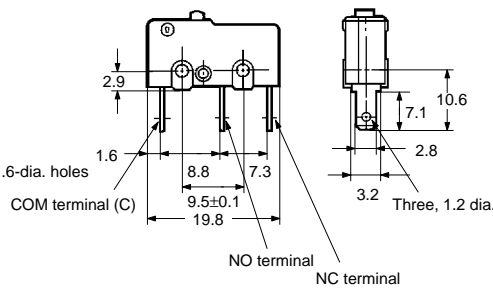

PCB Terminal

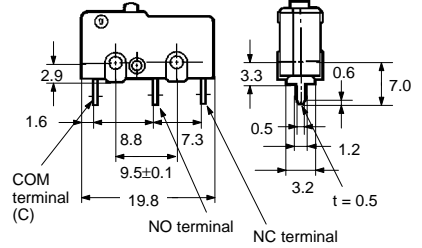

PCB Mounting Dimensions (Reference)

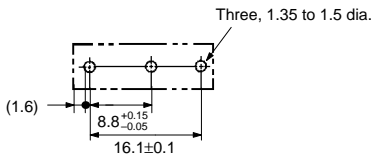

Mounting Holes

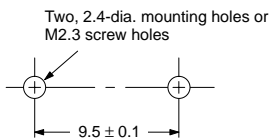

■ Dimensions and Operating Characteristics

Note: 1. All units are in millimeters unless otherwise indicated.

2. The following illustration and drawing are for solder terminal models. Refer to page 159 for details on models with quick-connect terminals (#110) or PCB terminals.
3. Unless otherwise specified, a tolerance of ± 0.4 mm applies to all dimensions.
4. The operating characteristics are for operation in the A direction (▼).

Pin Plunger

SS-01(-E, -F)
SS-5(-F)
SS-10

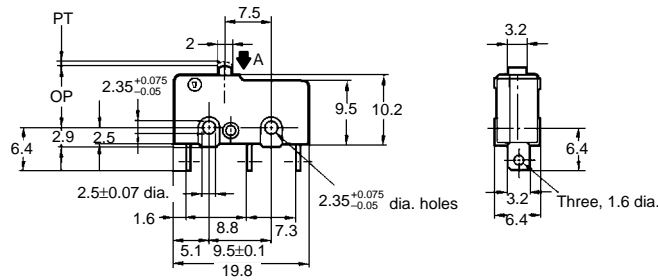
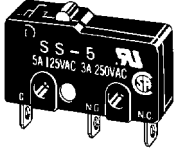

Model	SS-01-E	SS-01-F SS-5-F	SS-01 SS-5	SS-10
OF max.	0.25 N {25 gf}	0.49 N {50 gf}	1.47 N {150 gf}	1.47 N {150 gf}
RF min.	0.02 N {2 gf}	0.04 N {4 gf}	0.25 N {25 gf}	0.25 N {25 gf}
PT max.	0.5 mm	0.5 mm	0.5 mm	0.6 mm
OT min.	0.5 mm	0.5 mm	0.5 mm	0.4 mm
MD max.	0.1 mm	0.1 mm	0.1 mm	0.12 mm
OP	8.4±0.5 mm			

Hinge Lever

SS-01GL(-E, -F)
SS-5GL(-F)
SS-10GL

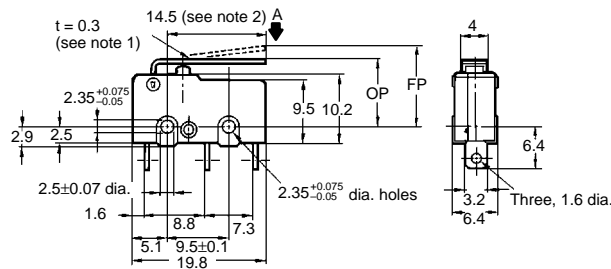
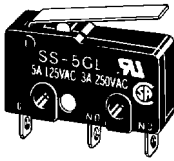

Note: 1. Stainless-steel lever

2. Besides the SS-□GL models with a hinge lever length of 14.5, the SS-□GL11 models with a hinge lever length of 18.5, the SS-□GL111 models with a hinge lever length of 22.6, and the SS-□GL1111 models with a hinge lever length of 37.8 are available. Contact your OMRON representative for these models

Model	SS-01GL-E	SS-01GL-F SS-5GL-F	SS-01GL SS-5GL	SS-10GL
OF max.	0.08 N {8 gf}	0.16 N {16 gf}	0.49 N {50 gf}	0.49 N {50 gf}
RF min.	(0.01 N {1 gf})	0.02 N {2 gf}	0.06 N {6 gf}	0.06 N {6 gf}
OT min.	1.2 mm	1.2 mm	1.2 mm	1.0 mm
MD max.	0.8 mm	0.8 mm	0.8 mm	1.0 mm
FP max.	13.6 mm			
OP	8.8±0.8 mm			

Note: The values indicated in parentheses are reference values for cases when the installation direction is such that the lever weight is not applied to the plunger.

Simulated Roller Lever

SS-01GL13(-E, -F)
SS-5GL13(-F)
SS-10GL13

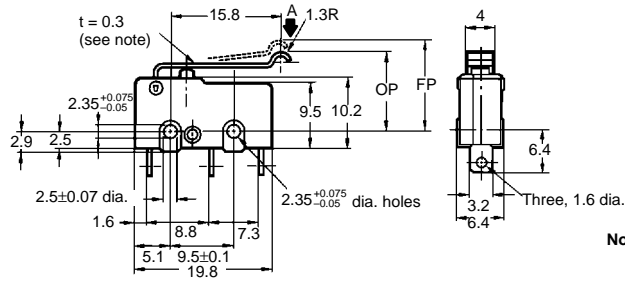
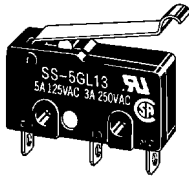

Note: Stainless-steel spring lever

Model	SS-01GL13-E	SS-01GL13-F SS-5GL13-F	SS-01GL13 SS-5GL13	SS-10GL13
OF max.	0.08 N {8 gf}	0.16 N {16 gf}	0.49 N {50 gf}	0.49 N {50 gf}
RF min.	(0.01 N {1 gf})	0.02 N {2 gf}	0.06 N {6 gf}	0.06 N {6 gf}
OT min.	1.2 mm	1.2 mm	1.2 mm	1.0 mm
MD max.	0.8 mm	0.8 mm	0.8 mm	1.0 mm
FP max.	15.5 mm			
OP	10.7 ± 0.8 mm			

Note: The values indicated in parentheses are reference values for cases when the installation direction is such that the lever weight is not applied to the plunger.

Hinge Roller Lever

SS-01GL2(-E, -F)
SS-5GL2(-F)
SS-10GL2

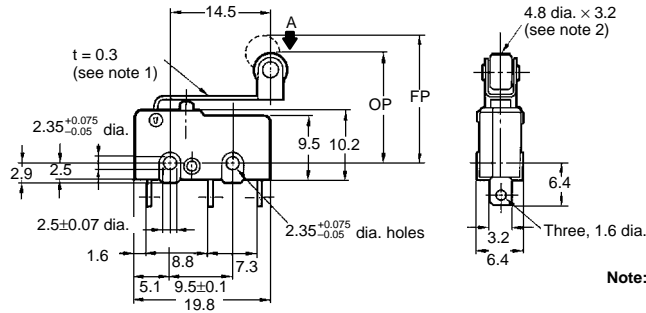
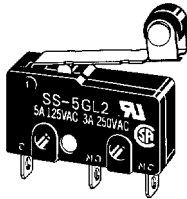

Note: 1. Stainless-steel spring lever
2. Polyacetal resin roller

Model	SS-01GL2-E	SS-01GL2-F SS-5GL2-F	SS-01GL2 SS-5GL2	SS-10GL2
OF max.	0.08 N {8 gf}	0.16 N {16 gf}	0.49 N {50 gf}	0.49 N {50 gf}
RF min.	(0.01 N {1 gf})	0.02 N {2 gf}	0.06 N {6 gf}	0.06 N {6 gf}
OT min.	1.2 mm	1.2 mm	1.2 mm	1.0 mm
MD max.	0.8 mm	0.8 mm	0.8 mm	1.0 mm
FP max.	19.3 mm			
OP	14.5 ± 0.8 mm			

Note: The values indicated in parentheses are reference values for cases when the installation direction is such that the lever weight is not applied to the plunger.

Precautions

Refer to pages 26 to 33 for common precautions.

■ Cautions

Terminal Connection

When soldering the lead wire to the terminal, first insert the lead wire conductor through the terminal hole and then conduct soldering.

Make sure that the capacity of the soldering iron is 60 W maximum. Do not take more than 5 s to solder the switch terminal. Improper soldering involving an excessively high temperature or excessive soldering time may deteriorate the characteristics of the Switch.

Be sure to apply only the minimum required amount of flux. The Switch may have contact failures if flux intrudes into the interior of the Switch.

Use the following lead wires to connect to the solder terminals.

Model	Conductor size
SS-5	0.5 to 0.75 mm ²
SS-10	0.75 mm ²

If the PCB terminal models are soldered in the solder bath, flux will permeate inside the Switch and cause contact failure. Therefore, manually solder the PCB terminal.

Wire the quick-connect terminals (#110) with receptacles. Insert the terminals straight into the receptacles. Do not impose excessive force on the terminal in the horizontal direction, otherwise the terminal may be deformed or the housing may be damaged.

Insulation Distance

According to EN61058-1, the minimum insulation thickness for this Switch should be 1.1 mm and minimum clearance distance between the terminal and mounting plate should be 1.6 mm. If the insulation distance cannot be provided in the product incorporating the Switch, either use a Switch with insulation barrier or use a Separator to ensure sufficient insulation distance. Refer to Separator on page 86.

■ Correct Use

Mounting

Turn OFF the power supply before mounting or removing the Switch, wiring, or performing maintenance or inspection. Failure to do so may result in electric shock or burning.

Use M2.3 mounting screws with plane washers or spring washers to securely mount the Switch. Tighten the screws to a torque of 0.23 to 0.26 N • m (2.3 to 2.7 kgf • cm).

Mount the Switch onto a flat surface. Mounting on an uneven surface may cause deformation of the Switch, resulting in faulty operation or breakage in the housing.

Operating Stroke Setting

Take particular care in setting the operating stroke for the pin plunger models. Make sure that the operating stroke is 70% to 100% of the rated OT distance. Do not operate the actuator exceeding the OT distance, otherwise the life expectancy of the Switch may be shortened.

Using Micro Loads

Using a model for ordinary loads to open or close the contact of a micro load circuit may result in faulty contact. Use models that operate in the following range. However, even when using micro load models within the operating range shown below, if inrush current occurs when the contact is opened or closed, it may increase contact wear and so decrease life expectancy. Therefore, insert a contact protection circuit where necessary.

The minimum applicable load is the N-level reference value. This value indicates the malfunction reference level for the reliability level of 60% ($\lambda 60$). The equation, $\lambda 60 = 0.5 \times 10^{-6}/\text{operations}$ indicates that the estimated malfunction rate is less than 1/2,000,000 operations with a reliability level of 60%.

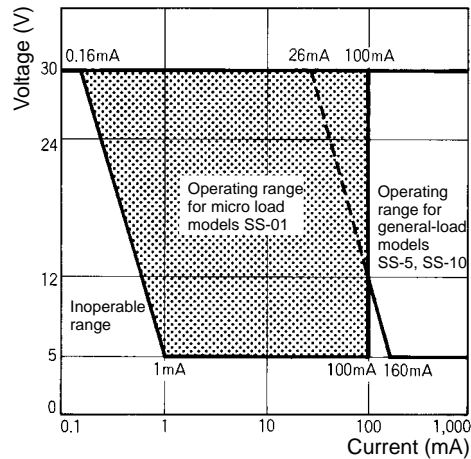

■ Separators

Applicable Switch	Thickness (mm)	Model (see note)
SS, D2S, D2SW	0.18	Separator for SS0.18
	0.4	Separator for SS0.4

Separator for SS

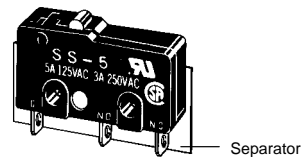

Note: The material is EAVTC (Epoxide Alkyd Varnished Tetrone Cloth) and its heat-resisting temperature is 130°C.

■ Connector

Refer to Terminal Connectors on page 238.

ALL DIMENSIONS SHOWN ARE IN MILLIMETERS.
To convert millimeters into inches, multiply by 0.03937. To convert grams into ounces, multiply by 0.03527.