

NAIS

8 A POWER RELAY

JG-RELAYS

FEATURES

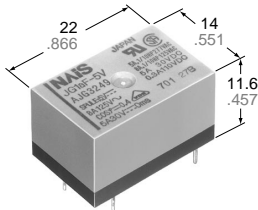

mm inch

- **Compact & flat design:** 22 mm .866 inch (length) × 14 mm .551 inch (width) × 11.6 mm .457 inch (height)
- **High capacity:** 8 A nominal switching capacity
- **High surge resistance:** Min. 10,000 V between contact and coil
- **High sensitivity:** 200 mW nominal operating power
- **VDE, TÜV, SEMKO also approved**

SPECIFICATIONS

Contact

Arrangement	1 Form A	
Initial contact resistance, max. (By voltage drop 6 V DC 1A)	100 mΩ	
Contact material	Silver alloy	
Rating (resistive load)	Nominal switching capacity	8 A 125 V AC 5 A 250 V DC 5 A 30 V DC
	Max. switching power	1,250 VA, 150 W
	Max. switching voltage	250 V AC, 110 V DC (0.3 A)
	Max. switching current	8 A (AC), 5A (DC)
Expected life (min. operations)	Mechanical (at 180 cpm)	5×10 ⁶
	Electrical (at 8 A 125 V AC) (at 20 cpm)	10 ⁵

Coil

Nominal operating power	200 mW
-------------------------	--------

Remarks

- * Specifications will vary with foreign standards certification ratings.
- *1 Measurement at same location as "Initial breakdown voltage" section
- *2 Detection current; 10 mA
- *3 Wave is standard shock voltage of $\pm 1.2 \times 50\mu s$ according to JEC-212-1981
- *4 Excluding contact bounce time
- *5 Half-wave pulse of sine wave: 11ms; detection time: 10μs
- *6 Half-wave pulse of sine wave: 6ms
- *7 Detection time: 10μs
- *8 Refer to 5. Conditions for operation, transport and storage mentioned in AMBIENT ENVIRONMENT (Page 61).

Characteristics

Max. operating speed	20 cpm	
Initial insulation resistance*1	Min. 100 mΩ at 500 V DC	
Initial breakdown voltage*2	Between open contacts	750 Vrms for 1 min.
	Between contacts and coil	2,000 Vrms for 1 min.
Surge voltage between contact and coil*3	Min. 10,000 V	
Operate time*4 (at nominal voltage)	Approx. 5 ms	
Release time*4 (at nominal voltage)(without diode)	Approx. 3 ms	
Temperature rise (Ambient temperature: 70°C)	Max. 45°C with nominal coil voltage and at 8 A contact current	
Shock resistance	Functional*5	Min. 98 m/s ² {10 G}
	Destructive*6	Min. 980 m/s ² {100 G}
Vibration resistance	Functional*7	98 m/s ² {10 G}, 10 to 55 Hz at double amplitude of 1.6 mm
	Destructive	117.6 m/s ² {12 G}, 10 to 55 Hz at double amplitude of 2 mm
Conditions for operation, transport and storage*8 (Not freezing and condensing at low temperature)	Ambient temp.	-40°C to +70°C -40°F to +158°F
	Humidity	5 to 85% R.H.
Unit weight	Approx. 7 g .25 oz	

TYPICAL APPLICATIONS

- Microwave ovens
- Small household appliances
- Water heaters
- Electric irons
- Coffee makers

ORDERING INFORMATION

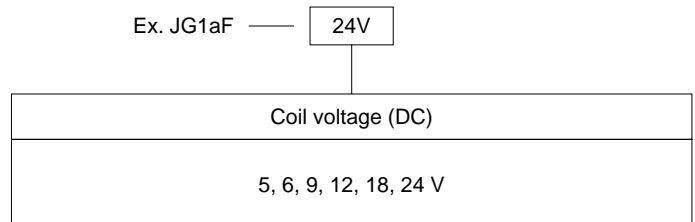

Note: Standard packing: 100 pcs. Case: 500 pcs. UL/CSA, VDE approved type is standard.

TYPES AND COIL DATA

Part No.	Nominal voltage, V DC	Pick-up voltage, V DC (max.) (at 20°C 68°F)	Drop-out voltage, V DC (min.) (at 20°C 68°F)	Coil resistance, Ω (±10%) (at 20°C 68°F)	Nominal operating current, mA (±10%) (at 20°C 68°F)	Nominal operating power, mW	Max. allowable voltage, V DC (at 70°C 158°F)
JG1aF-5V	5	4.0	0.25	125	40	200	6.5
JG1aF-6V	6	4.8	0.3	180	33	200	7.8
JG1aF-9V	9	7.2	0.45	405	22	200	11.7
JG1aF-12V	12	9.6	0.6	720	17	200	15.6
JG1aF-18V	18	14.4	0.9	1,620	11	200	23.4
JG1aF-24V	24	19.2	1.2	2,880	8.3	200	31.2

DIMENSIONS

mm inch

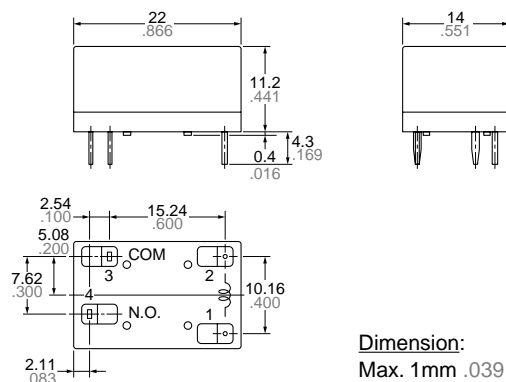

PC board pattern (Copper-side view)

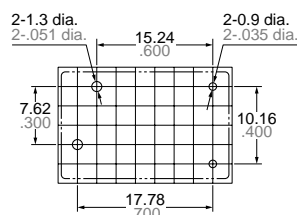

Tolerance: ±0.1 ±.004

Dimension:

Max. 1mm .039 inch:
1 to 5mm .039 to .118 inch:
Min. 5mm .118 inch:

General tolerance

±0.2±.008
±0.3 ±.012
±0.4 ±.016

REFERENCE DATA

1. Maximum value for switching capacity

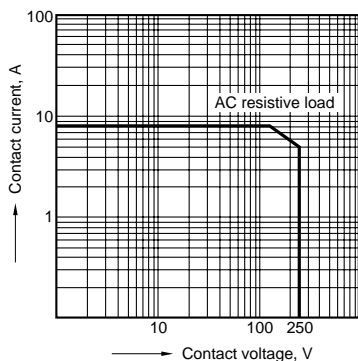

2. Operate/release time

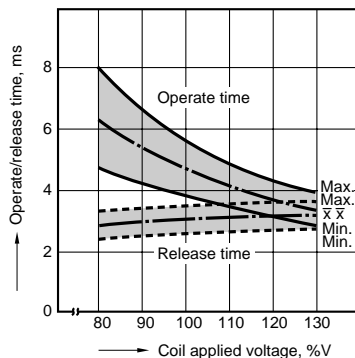

3. Coil temperature rise

Point measured: Inside the coil
Contact current: 8A

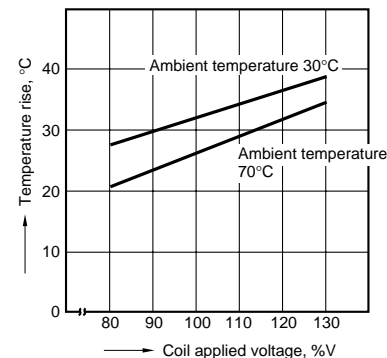

4. Ambient temperature characteristics

Contact current: 8 A

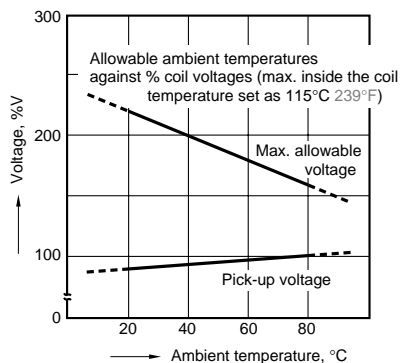

5. Life curve

Operation frequency: 20 times/min.
(ON/OFF = 1.5 s : 1.5 s)
Ambient temperature: Room temperature

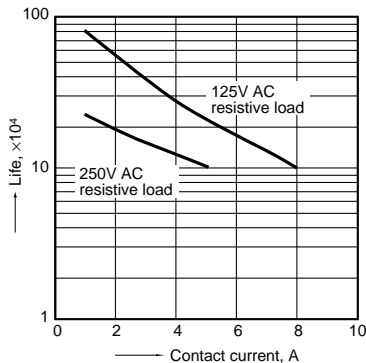

6. Electrical life test

(5.8 A 100 V AC resistive load)

Sample: JG1aF-12V, 6 pcs.

Operating speed: 20 cpm

Ambient temperature: 80°C 176°F

Circuit

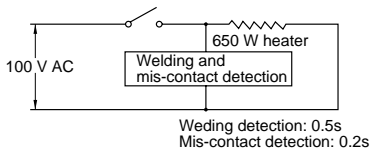

Change of pick-up and drop-out voltage

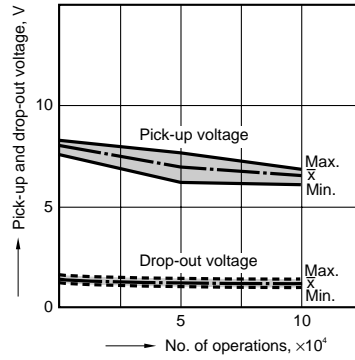

Change of contact resistance

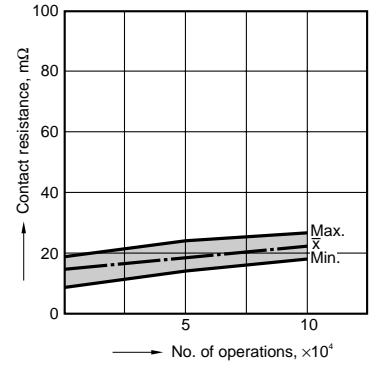

7. Electrical noise resistance characteristics between contact and coil

Sample: JG1aF-12V

Circuit

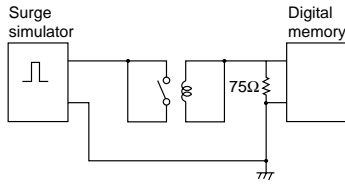

Noise wave

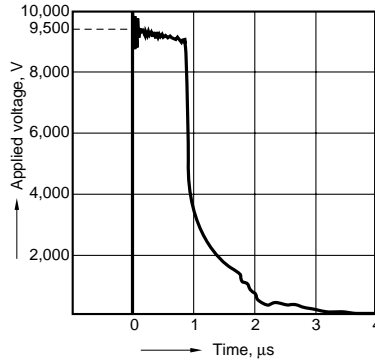

Output wave

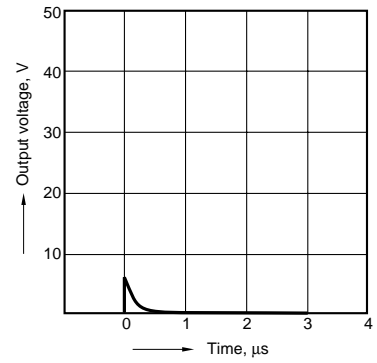

For Cautions for Use, see Relay Technical Information (Page 48 to 76).