

METAL OXIDE VARISTOR

ZENAMIC



ZENAMIC is the product name of a metal oxide varistor. ZENAMIC Transient/Surge Absorber, Series D is newly released through our continued research in ceramic material composition of ZnO varistor and manufacturing process, featuring large surge current handling capability and energy handling capability for absorbing transient overvoltage in compact size.

Features

- Improved in "Surge Current Handling Capability (at 8/20 μ s, 2 times)" by about 2 times over the current.
- Very large "Energy Handling Capability" absorbing transient overvoltages in compact sizes.
- Lower Clamping Voltage for better surge protection.
- Fast response to high speed transient/surge voltage.
- Wide products range for transient/surge protection on AC 100V to AC 480V nominal system with the maximum peak current ratings of 600A to 7000A (at 8/20 μ s, 2 times).

V-I characteristics

ZENAMIC has the forward-reverse symmetrical electrical characteristics as shown in the figure 1. The voltage-current curves show the varistor characteristics in the range 1 μA to 10⁴A, and show the resistance characteristics for the range under 1 μA and over 10⁴A in the figure 2. The voltage across terminals when test current(I_t: 1 mA) is applied to ZENAMIC is the standard varistor voltage(V_Z), and the voltage across terminals when a standard surge(I_p) is applied represents the maximum suppression voltage(V_C).

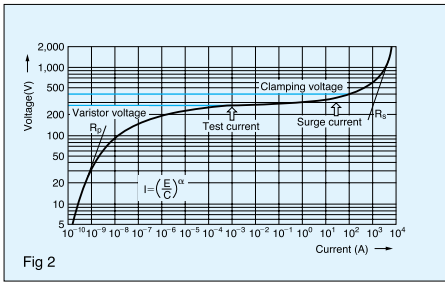
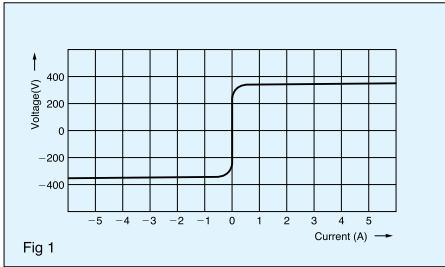

Temperature characteristics

In the small current range, ZENAMIC features outstanding temperature characteristics. A shunt resistance R_p of metal oxide varistor has the temperature characteristics which is determined by the following equation.

$$R_p = A e^{E_g / 2kT} \quad (2)$$

T: Absolute temperature
k: Boltzmann constant
A, E_g: constants

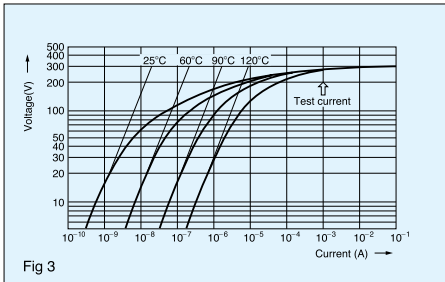

As shown in the figure 3, the temperature dependence characteristics are shown clearly in the low current area.

Surge waveform

A surge waveform varies according to the sources. An EXP waveform is used for surge testing of ZENAMIC, while a AC half-wave is used for the energy absorption test. The EXP waveform reaches its peak voltage (current) at [t_a] as shown in the figure 5, and then decreases as time passes and reaches half of the peak voltage (current) at [t_b]. This type of the EXP waveform is shown as a [t_a/t_b] voltage (current) waveform. For surge testing of ZENAMIC, the 8/20 μ sec current waveform is used.

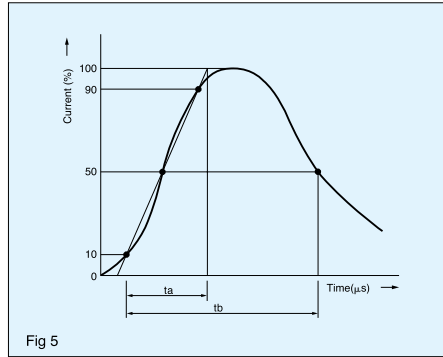

Part Number.

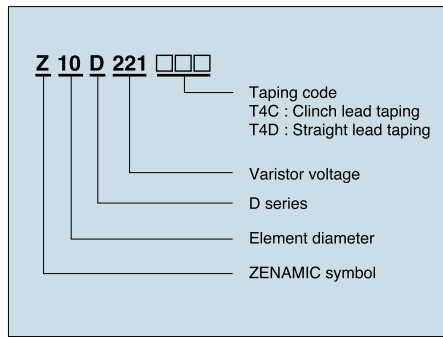

Application notes(General)

1. A surge excess of the specified Maximum Peak Current may cause short circuit or mechanical damage. The following measures are recommended.
 - In case that ZENAMIC is used in line to ground, the ground fault circuit interrupter shall be applied in location A or thermally coupled fuse shall be applied in location C.
 - ZENAMIC shall not be used near heat generating device and free from direct sunlight.
 - ZENAMIC shall not be used near the flammable materials.

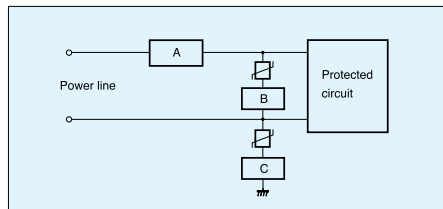

- 1) Location of the over current protector(circuit breaker or current fuse) shall be in the power line to the circuit(Location A) or in series with ZENAMIC (Location B).
- 2) It recommended that a fuse listed in the table be put in location A or B.

- 3) In case that ZENAMIC is used in line to ground, the ground fault circuit interrupter should be applied in location A or thermally coupled fuse should be applied in location C.

Part Number	Z7D□□□	Z10D□□□
Rating of fuse	5A max.	7A max.

Part Number	Z15D□□□	Z21D□□□
Rating of fuse	10A max.	15A max.

Refer to the related Safety Standards.

Applications

Power lines and surge absorption units with error display (SA series).

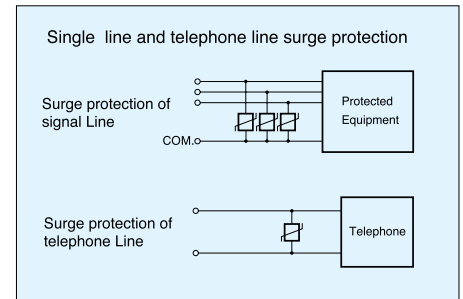
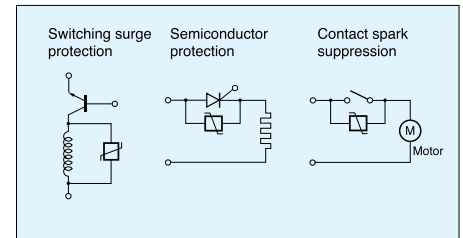
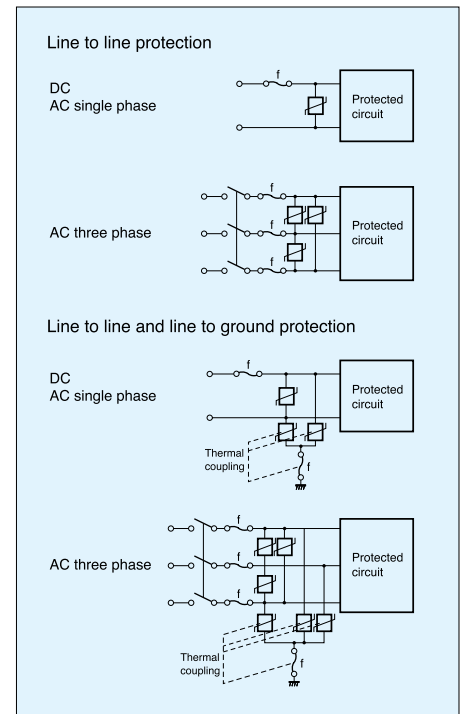

Z7D Series Specifications

Part No.	Varistor Voltage	Maximum Allowable Voltage		Clamping Voltage (max.)	Rated Power	Maximum Energy		Maximum Peak Current (8/20μs) 2 times	Capacitance (TYP) 1kHz
		V _{1mA} (V)	AC _{rms} (V)			DC(V)	V(V)		
Z7D180	18(16-20)	11	14	36 at 2.5A	0.02	1.1	0.9	250	3800
Z7D220	22(20-24)	14	18	43		1.3	1.1		3600
Z7D270	27(24-30)	17	22	53		1.6	1.3		3400
Z7D330	33(30-36)	20	26	65		2.0	1.6		2900
Z7D390	39(35-43)	25	31	77		2.4	1.9		1600
Z7D470	47(42-52)	30	38	93		2.8	2.3		1550
Z7D560	56(50-62)	35	45	110		3.4	2.7		1500
Z7D680	68(61-75)	40	56	135		4.1	3.3		1200
*1 Z7D820	82(74-90)	50	65	135 at 10A		7	5		810
*1 Z7D101	100(90-110)	60	85	165		8.5	6		700
*1 Z7D121	120(108-132)	75	100	200	10	7	590		
*1 Z7D151	150(135-165)	95	125	250	13	9	500		
*1 Z7D201	200(185-225)	130	170	340	17.5	12.5	200		
*1 Z7D221	220(198-242)	140	180	360	19	13.5	190		
*1 Z7D241	240(216-264)	150	200	395	21	15	170		
*1 Z7D271	270(247-303)	175	225	455	24	17	150		
*1 Z7D331	330(297-363)	210	270	545	28	20	130		
*1 Z7D361	360(324-396)	230	300	595	32	23	130		
*1 Z7D391	390(351-429)	250	320	650	35	25	130		
*1 Z7D431	430(387-473)	275	350	710	40	27.5	120		
*1 Z7D471	470(423-517)	300	385	775	42	30	100 *2		
*1 Z7D511	510(459-561)	320	410	845	45	32	90 *2		

1. Operating temperature range: -40 to 85°C
 2. Storage temperature range: -40 to 125°C
 *1 UL 1449 approved model
 *2 Measured at 1MHz

Z10D Series Specifications

Part No.	Varistor Voltage	Maximum Allowable Voltage		Clamping Voltage (max.)	Rated Power	Maximum Energy		Maximum Peak Current (8/20μs) 2 times	Capacitance (TYP) 1kHz
		V _{1mA} (V)	AC _{rms} (V)			DC(V)	V(V)		
Z10D180	18(16-20)	11	14	36 at 5A	0.05	2.6	2.2	500	16000
Z10D220	22(20-24)	14	18	43		3.2	2.6		11000
Z10D270	27(24-30)	17	22	53		3.9	3.2		8000
Z10D330	33(30-36)	20	26	65		4.8	4.0		6300
Z10D390	39(35-43)	25	31	77		5.6	4.7		5200
Z10D470	47(42-52)	30	38	93		6.8	5.6		4600
Z10D560	56(50-62)	35	45	110		8.1	6.7		3750
Z10D680	68(61-75)	40	56	135		9.8	8.2		2800
* Z10D820	82(74-90)	50	65	135 at 25A		14	10		2000
* Z10D101	100(90-110)	60	85	165		17	12		1700
* Z10D121	120(108-132)	75	100	200	20	14.5	1400		
* Z10D151	150(135-165)	95	125	250	25	18	1100		
* Z10D201	200(185-225)	130	170	340	35	25	430		
* Z10D221	220(198-242)	140	180	360	39	27.5	410		
* Z10D241	240(216-264)	150	200	395	42	30	380		
* Z10D271	270(247-303)	175	225	455	49	35	350		
* Z10D331	330(297-363)	210	270	545	58	42	300		
* Z10D361	360(324-396)	230	300	595	65	45	300		
* Z10D391	390(351-429)	250	320	650	70	50	300		
* Z10D431	430(387-473)	275	350	710	80	55	270		
* Z10D471	470(423-517)	300	385	775	85	60	230		
* Z10D511	510(459-561)	320	410	845	92	67	210		
* Z10D561	560(504-616)	350	450	930	92	67	200		
* Z10D681	680(612-748)	420	560	1120	92	67	170		
* Z10D751	750(675-825)	460	615	1240	100	70	160		
* Z10D821	820(738-902)	510	670	1355	110	80	140		
* Z10D911	910(819-1001)	550	745	1500	130	90	120		
* Z10D102	1000(900-1100)	625	825	1650	140	100	110		

1. Operating temperature range: -40 to 85°C
 2. Storage temperature range: -40 to 125°C
 * UL 1449 approved model

Z15D Series Specifications

Part No.	Varistor Voltage	Maximum Allowable Voltage		Clamping Voltage (max.)	Rated Power	Maximum Energy		Maximum Peak Current (8/20μs) 2 times	Capacitance (TYP) 1kHz
		V _{1mA} (V)	AC _{rms} (V)			DC(V)	V(V)		
Z15D180	18(16-20)	11	14	36 at 10A	0.1	5.2	4.3	1000	25000
Z15D220	22(20-24)	14	18	43		6.3	5.3		20000
Z15D270	27(24-30)	17	22	53		7.8	6.5		16000
Z15D330	33(30-36)	20	26	65		9.5	7.9		12200
Z15D390	39(35-43)	25	31	77		11	9.4		7000
Z15D470	47(42-52)	30	38	93		14	11		6750
Z15D560	56(50-62)	35	45	110		16	13		6500
Z15D680	68(61-75)	40	56	135		20	16		5500
* Z15D820	82(74-90)	50	65	135 at 50A		28	20		3700
* Z15D101	100(90-110)	60	85	165		35	25		3200
* Z15D121	120(108-132)	75	100	200	42	30	2700		
* Z15D151	150(135-165)	95	125	250	53	37.5	2200		
* Z15D201	200(185-225)	130	170	340	70	50	770		
* Z15D221	220(198-242)	140	180	360	78	55	740		
* Z15D241	240(216-264)	150	200	395	84	60	700		
* Z15D271	270(247-303)	175	225	455	99	70	640		
* Z15D331	330(297-363)	210	270	545	115	80	580		
* Z15D361	360(324-396)	230	300	595	130	90	540		
* Z15D391	390(351-429)	250	320	650	140	100	500		
* Z15D431	430(387-473)	275	350	710	155	110	450		
* Z15D471	470(423-517)	300	385	775	175	125	400		
* Z15D511	510(459-561)	320	410	845	190	136	350		
* Z15D561	560(504-616)	350	450	930	190	136	340		
* Z15D681	680(612-748)	420	560	1120	190	136	320		
* Z15D751	750(675-825)	460	615	1240	210	150	310		
* Z15D821	820(738-902)	510	670	1355	235	165	280		
* Z15D911	910(819-1001)	550	745	1500	255	180	250		
* Z15D102	1000(900-1100)	625	825	1650	280	200	230		

1. Operating temperature range: -40 to 85°C * UL 1449 approved model
 2. Storage temperature range: -40 to 125°C

Z21D Series Specifications

Part No.	Varistor Voltage	Maximum Allowable Voltage		Clamping Voltage (max.)	Rated Power	Maximum Energy		Maximum Peak Current (8/20μs) 2 times	Capacitance (TYP) 1kHz
		V _{1mA} (V)	AC _{rms} (V)			DC(V)	V(V)		
Z21D180	18(16-20)	11	14	36 at 20A	0.2	13	12	2000	40000
Z21D220	22(20-24)	14	18	43		16	14		30000
Z21D270	27(24-30)	17	22	53		19	17		24500
Z21D330	33(30-36)	20	26	65		24	21		20000
Z21D390	39(35-43)	25	31	77		28	25		13800
Z21D470	47(42-52)	30	38	93		34	30		13500
Z21D560	56(50-62)	35	45	110		41	36		12200
Z21D680	68(61-75)	40	56	135		49	44		11500
* Z21D820	82(74-90)	50	65	135 at 100A		56	40		7500
* Z21D101	100(90-110)	60	85	165		70	50		6500
* Z21D121	120(108-132)	75	100	200	85	60	5500		
* Z21D151	150(135-165)	95	125	250	106	75	4500		
* Z21D201	200(185-225)	130	170	340	140	100	1700		
* Z21D221	220(198-242)	140	180	360	155	110	1600		
* Z21D241	240(216-264)	150	200	395	168	120	1500		
* Z21D271	270(247-303)	175	225	455	190	135	1300		
* Z21D331	330(297-363)	210	270	545	228	160	1100		
* Z21D361	360(324-396)	230	300	595	255	180	1100		
* Z21D391	390(351-429)	250	320	650	275	195	1100		
* Z21D431	430(387-473)	275	350	710	303	215	1000		
* Z21D471	470(423-517)	300	385	775	350	250	900		
* Z21D511	510(459-561)	320	410	845	382	273	800		
* Z21D561	560(504-616)	350	450	930	382	273	750		
* Z21D681	680(612-748)	420	560	1120	382	273	650		
* Z21D751	750(675-825)	460	615	1240	420	300	600		
* Z21D821	820(738-902)	510	670	1355	460	325	530		
* Z21D911	910(819-1001)	550	745	1500	510	360	500		
* Z21D102	1000(900-1100)	625	825	1650	565	400	450		

1. Operating temperature range: -40 to 85°C * UL 1449 approved model
 2. Storage temperature range: -40 to 125°C

Dimensions

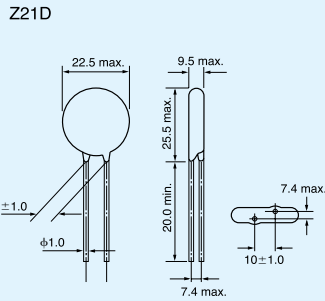
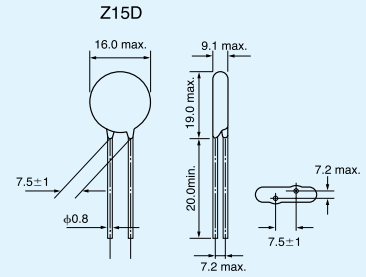
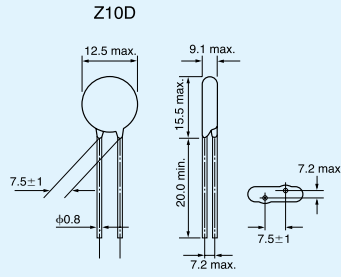
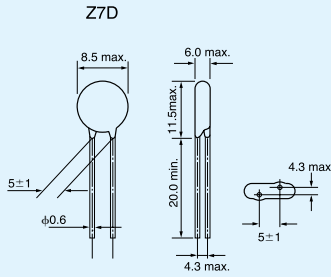

Crimped Leads and Taped
Z7D □□□ T4C

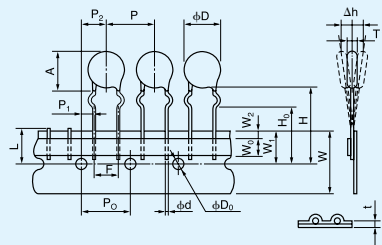

*Dimension "T": Conforms to each individual specification
*Packing quantity: 1000pcs/BOX

Symbol	Type I	Symbol	Type I
P	12.7±1.0	W ₀	5.0min
P ₀	12.7±0.3	W ₁	9.0±0.5
P ₁	3.85±0.70	W ₂	3max
P ₂	6.35±1.30	H	Approx. 22
φd	0.60 ^{+0.05} _{-0.05}	H ₀	17.0±0.5
F	5.0±0.5	φD ₀	φ4.0±0.2
Δh	0±2	t	0.6±0.3
W	18.0 ^{-1.0} _{-0.5}	L	11max
φD	Z7D:8.5max		

Straight Leads and Taped
Z7D □□□ T4D

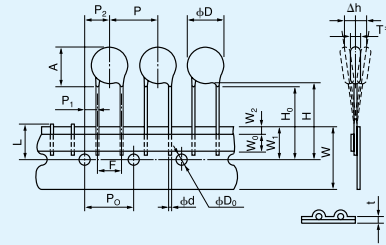

*Dimension "T": Conforms to each individual specification
*Packing quantity: 1000pcs/BOX

Symbol	Type I	Symbol	Type I
P	12.7±1.0	W ₀	5.0min
P ₀	12.7±0.3	W ₁	9.0±0.5
P ₁	3.85±0.70	W ₂	3max
P ₂	6.35±1.30	H	Approx. 20
φd	0.60 ^{+0.05} _{-0.05}	H ₀	17.0±0.5
F	5.0±0.5	φD ₀	φ4.0±0.2
Δh	0±2	t	0.6±0.3
W	18.0 ^{-1.0} _{-0.5}	L	11max
		φD	Z7D:8.5max

Unit(mm)

Z25M, Z33M Series

Specifications

Part No.	Varistor voltage $V_{1mA}(V)$		Maximum allowable voltage		Clamping voltage	Rated power	Maximum energy (2ms)	Withstanding surge current (8/20 μ s)	Capacitance (TYP) (1kHz)
			AC	DC					
	Min	Max	V_{rms}	V	V	W	J	2 Times (A)	pF
Z25M221S	220(187 ~253)		120	165	380 at 150A	1.0	125	10000	3300
Z25M271S	270(229.5~310.5)		150	210	465		155		2200
Z25M331S	330(280.5~379.5)		175	245	570		185		1900
Z25M391S	390(331.5~448.5)		210	295	675		215		1700
Z25M441S	440(374 ~506)		240	335	760		225		1500
Z25M471S	470(399.5~540.5)		250	350	810		235		1500
Z25M561S	560(476 ~644)		300	420	970		260		1400
Z25M681S	680(578 ~782)		365	510	1175		280		1250
Z25M821S	820(697 ~943)		440	615	1415		330		800
Z25M102S	1000(850 ~1,150)		520	730	1725		375		500
Z33M221S	220(187 ~253)		120	165	380 at 200A	1.2	200	20000	5500
Z33M271S	270(229.5~310.5)		150	210	465		255		4200
Z33M331S	330(280.5~379.5)		175	245	570		310		3700
Z33M391S	390(331.5~448.5)		210	295	675		360		3200
Z33M441S	440(374 ~506)		240	335	760		370		2800
Z33M471S	470(399.5~540.5)		250	350	810		385		2600
Z33M561S	560(476 ~644)		300	420	970		425		2200
Z33M681S	680(578 ~782)		365	510	1175		460		1800
Z33M821S	820(697 ~943)		440	615	1415		580		1500
Z33M102S	1000(850 ~1150)		520	730	1725		620		1000

1. Operating temperature range: -40 to 85°C
2. Storage temperature range: -40 to 125°C

Dimensions

