

TO2-IT-A PPM Oxygen Sensor



Specifications:

Sensor Technology	Micro Fuel Cell
Signal Output ¹	285 - 590 uA
Measuring Range	0 - 10 PPM (Min) 0-10000PPM(Max)
Response Time T90	13 Seconds
Accuracy Full Scale ²	± 1% of Signal
Repeatability F.S.	± 0.5%
Temp Coefficient	2.54 % / °C
Operating Temp	0 to 50 °C
Storage Temp	0 to 45 °C
Recommended Flow	0.5 - 2 SCFH
Humidity	0 - 100% RH (Non-Condensing)
Expected Life ³	16 - 25 Months
Storage	6 Months
Warranty ⁴	9 Months
PCB Connection	Center Foil Negative Outer Foil Positive

For use in CO2 applications

1. Signal Output is measured in air at 25 °C, Sea Level.
2. Accuracy Full Scale is calculated with constant pressure and temperature & proper calibration (90% O2 Value on Full Scale Range). Drastic Temperature change can result in a maximum error of ± 10%.
3. Expected life is calculated when O2 < 1000 ppm @ 25 °C, Sea Level.
4. Southland Sensing warrants these sensors for the period noted above to be free from defects in materials and workmanship. Southland Sensing will not be held liable for sensors damaged due to customer neglect.

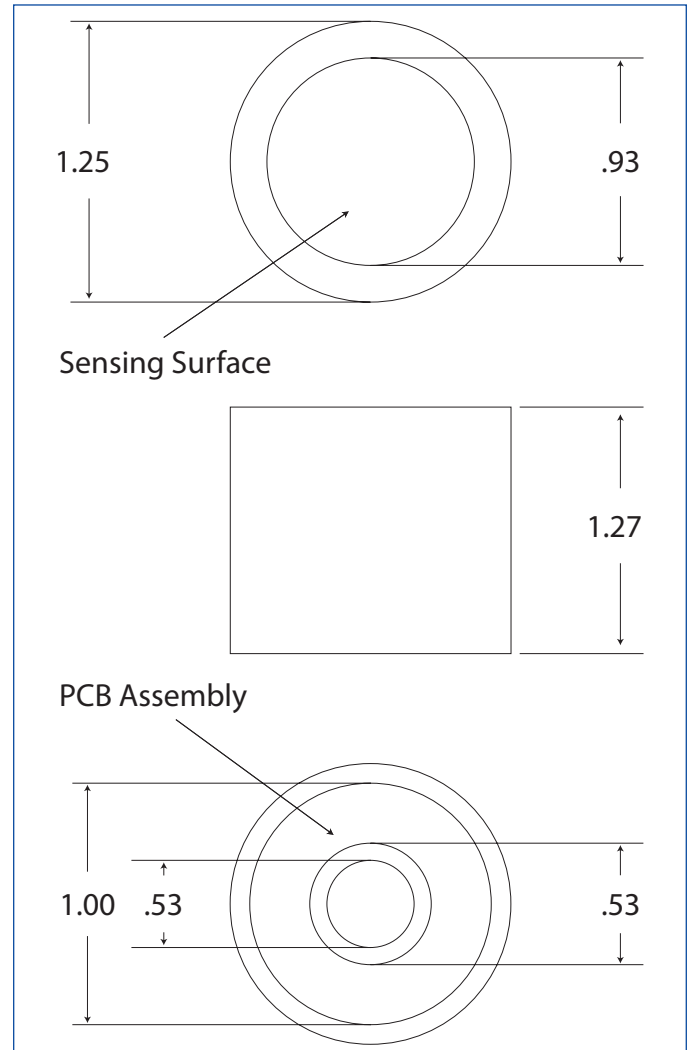

Direct Replacement Guide

Teledyne Analytical: Insta Trace, CO2 Applications