



Infrared Radiation Source JSIR350-4-AL-C-D5.8-0-0

Fast radiation source for use with thermopiles and pyroelectric detectors in NDIR gas analysis and other applications.

Spectral Output Range ¹	typ. 1 ... 20	μm
Active Area	2.2 x 2.2	mm ²
Hot Resistant	40±20	Ω
Temperature Coefficient	typ. 650	ppm/K
Time Constant	typ. 15	ms
Nominal Power Consumption	0.65	W
Operation Voltage ²	typ. 5.7	V
Operation Current ²	typ. 141	mA
Active Area Temperature ^{3,5}	640	°C
Window	-	
Mass	~1	g
Housing	T039 (modified)	
Lifetime ⁴	> 5,000 h at 740°C > 100,000 h at 640°C	

¹ without window

² with 40Ω

³ at nominal power (0.65W)

⁴ at 10 Hz, 50% duty cycle, preliminary results

⁵ at T_{amb} = 25°C

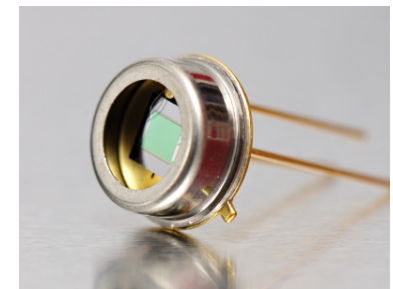

Pin Assignment

Bottom View

- Pin 1 Power
- Pin 2 Case
- Pin 3 Power

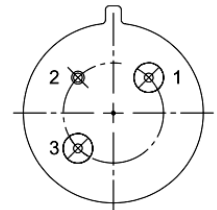

Absolute Max. Ratings		
Power	1.2	W
Housing temperature	200	°C
Active Area Temperature	850	°C

Infrared Radiation Source JSIR350-4-AL-C-D5.8-0-0

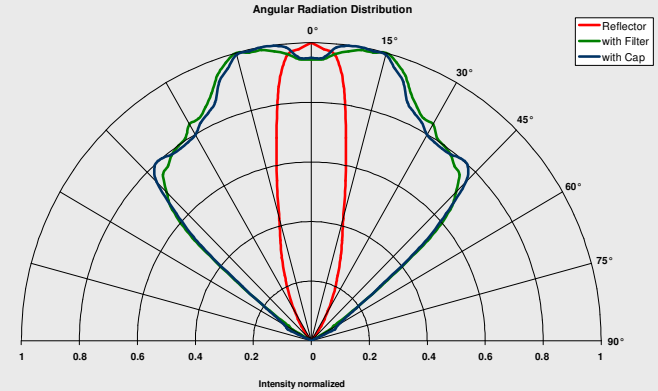
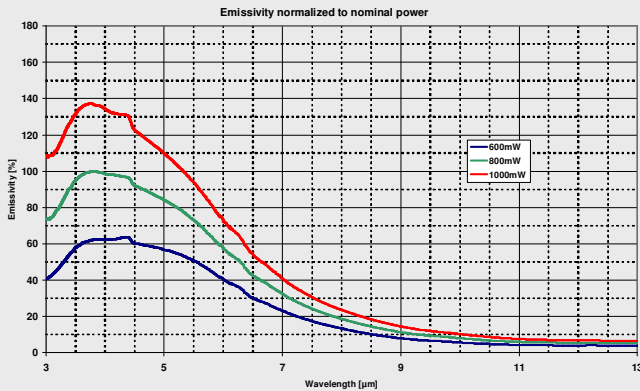
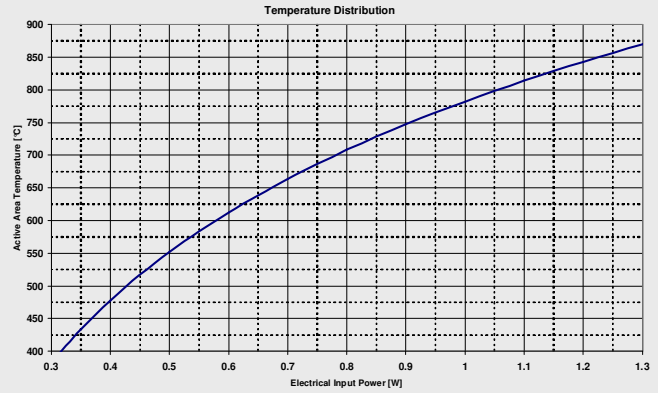
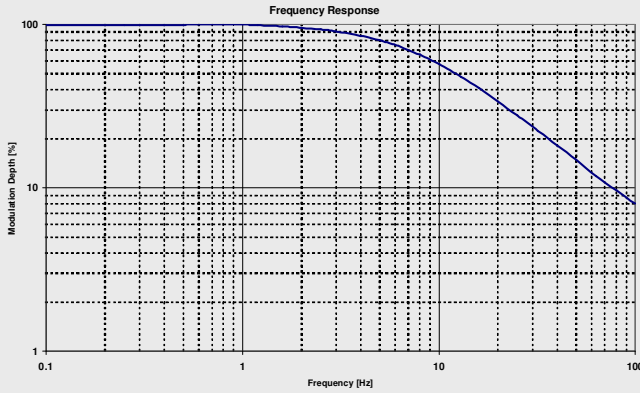

Housing

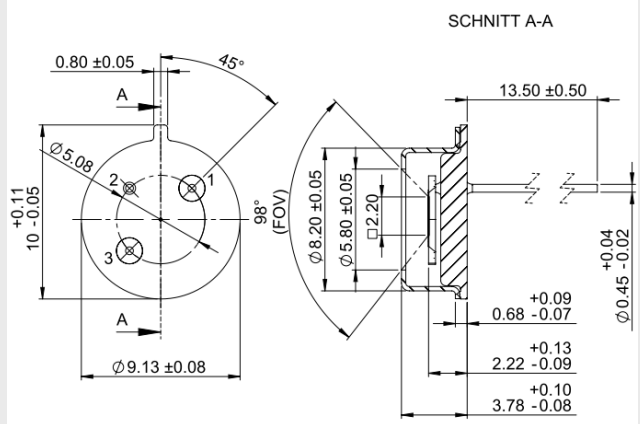

Operation range

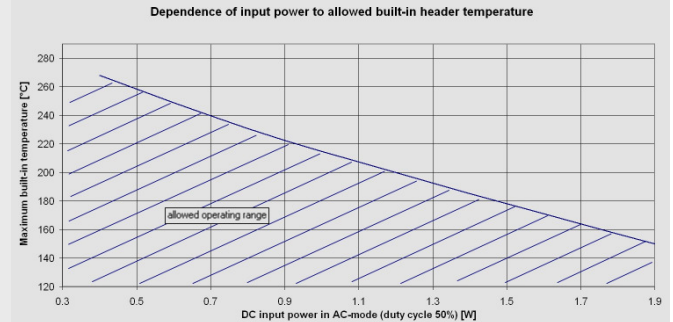

Optional parts

Reflector - For bunching of radiation

Window - For hermetic sealing and / or spectral narrowing of the radiation

Evaluation Kit - For independent evaluation of emitters and detectors