

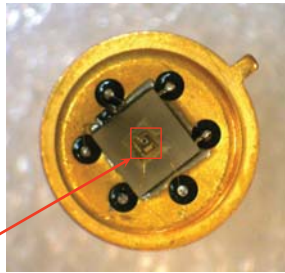

Features

- High reliability
- Spectral Selectivity
- Easy to use in lock-in circuits
- Temperature stabilization

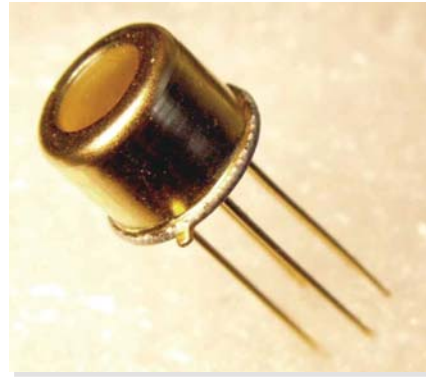

LED chip

Description

Light emitting diode **LED46-TEC** demonstrates typical maximum of emitting wavelength of $\lambda_P = 4.6 \mu\text{m}$ ($I = 150 \text{ mA}$, $f = 0.5 \text{ KHz}$, duty cycle: 50%).

Light emitting diode **LED46-TEC** is equipped with sapphire window, thermo-electrical cooler (TEC) and thermistor for stabilizing of temperature.

The components is mounted in a standard 9.2 mm TO-5 package.

LED heterostructure is grown on InAs substrate.

Related products: **LED46-TEC** can be used in optical pair with our [PD48-05-WS](#) photodiodes.

General characteristics

Package	Parameter	Symbol	Value	Unit
TO-5 with TEC	Maximum operating current	I_{QCW}^*	220	mA
		I_{Pulsed}^{**}	2000	
	Soldering temperature	T_s	+ 230	$^{\circ}\text{C}$
	Operating temperature	T_{opr}	- 30...+ 50	$^{\circ}\text{C}$
	Storage temperature	T_{stg}	- 55...+ 60	$^{\circ}\text{C}$
	Weight	m	1.15	g
	Size	D		9.2
H			20.2	

* Quasi-CW mode: Repetition rate: 0.5 kHz, pulse duration: 1 ms, duty cycle: 50%
SUNSTAR自动化 http://www.sensor-ic.com/ TEL: 0755-83376489 FAX: 0755-83376182 E-MAIL: szss20@163.com

** Pulse mode: Repetition rate: 0.5 kHz, pulse duration: 2 μs , duty cycle: 0.1%



Electrical and optical characteristics

Parameter	Symbol	Condition	Min	Max	Unit
Peak emission wavelength	λ_p	$I_F = 150 \text{ mA}$	$\lambda_{typ} = 4.6$		μm
			4.4	4.66	
Spectral FWHM	$\Delta\lambda$	$I_F = 150 \text{ mA}$	800	1000	nm
Pulse optical power	P^*_{OCW}	$I_F = 200 \text{ mA}$	4	12	μW
	P^{**}_{Pulsed}	$I_F = 1000 \text{ mA}$	20	55	
Forward voltage	V_F	(*)	0.3	0.8	V
Switching time	τ		10	30	ns

* Quasi-CW mode: repetition rate: 0.5 kHz, pulse duration: 1 ms, duty cycle: 50%, current: 200 mA

** Pulse mode: repetition rate: 0.5 kHz, pulse duration: 2 μs , duty cycle: 0.1%, current: 1 A

TEC TO506.1MC0400710.TB103 parameters (without load)

Parameter	Symbol	Condition	Value	Unit
Maximum Current	I_{max}	ΔT_{max}	1.50	A
Maximum Voltage	U_{max}	ΔT_{max}	0.80	V
Cooling power	q_{max}	-	1.30	W
Temperature range	ΔT_{max}	vacuum	70	K
Thermistor resistance	R_t	$T = + 20 \text{ }^\circ\text{C}$	10.00	kOhm



Electro Optical Components, Inc.

5460 Skylane Boulevard, Santa Rosa, CA 95403

Phone: (707) 568-1642 • FAX: (707) 568-1652

SUNSTAR自动化 <http://www.sensor-ic.com/> TEL: 0755-83376489 FAX: 0755-83376182 E-MAIL: szss20@163.com

www.eoc-inc.com



Electroluminescence spectra

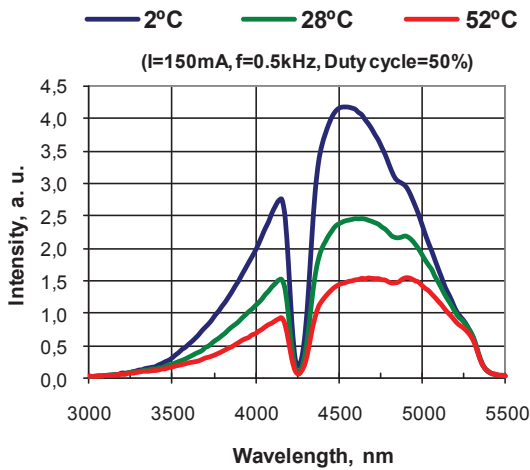

Pulse optical power vs. current

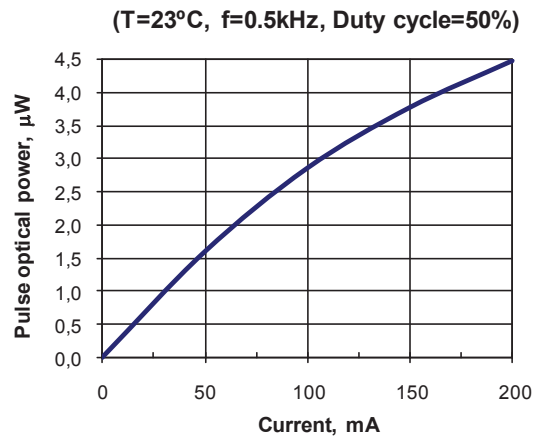

Current vs. voltage

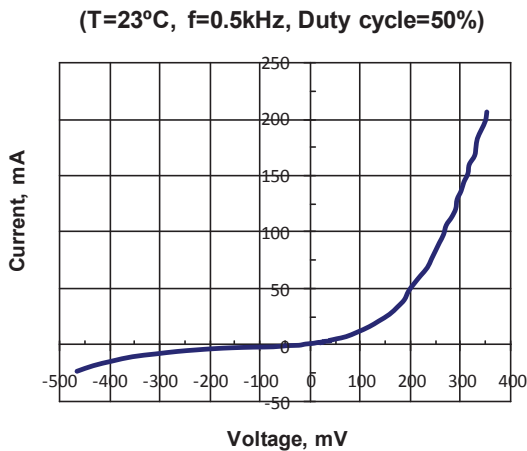

Field pattern

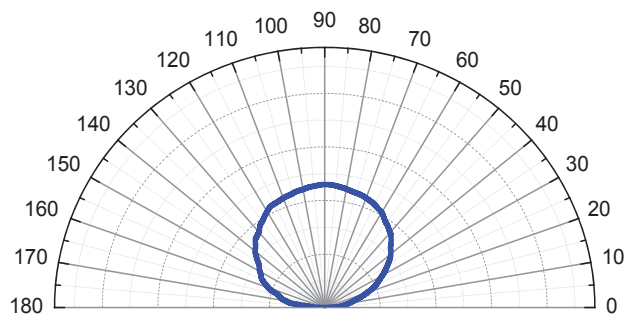

Electro Optical Components, Inc.

5460 Skylane Boulevard, Santa Rosa, CA 95403

Phone: (707) 568-1642 • FAX: (707) 568-1652

SUNSTAR自动化 <http://www.sensor-ic.com/> TEL: 0755-83376489 FAX:0755-83376182 E-MAIL:szss20@163.com

www.eoc-inc.com



TO-5 package — dimensions (mm)

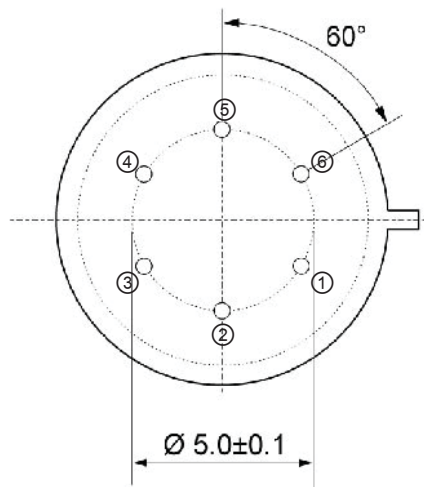
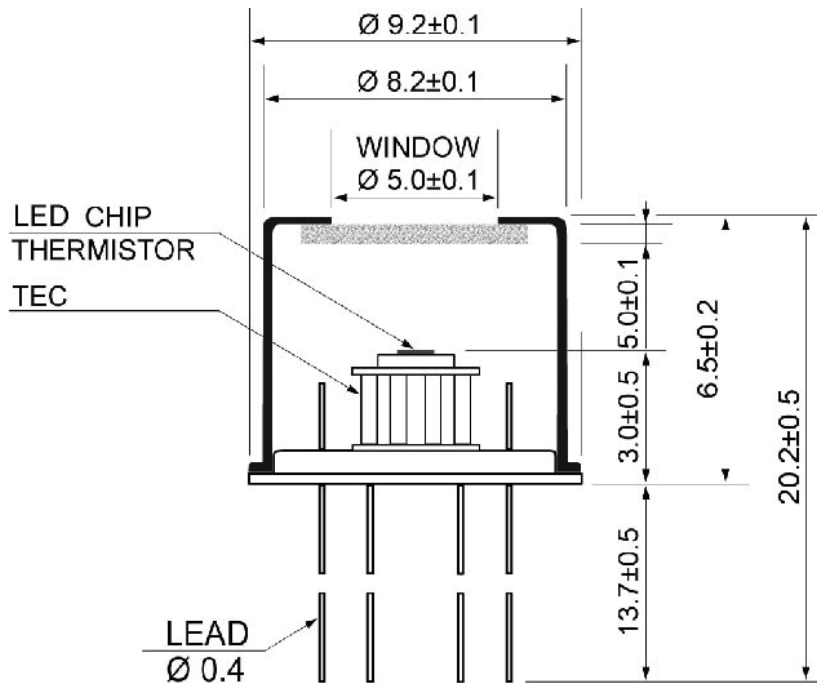

Pin	Description
①	TEC (anode)
②	Diode (anode)*
③	Diode (cathode)*
④	Thermistor TC103
⑤	
⑥	TEC (cathode)

* Attention: Pin polarity can be changed on request.



Electro Optical Components, Inc.

5460 Skylane Boulevard, Santa Rosa, CA 95403

Phone: (707) 568-1642 FAX: (707) 568-1653
 SUNSTAR 自动化 <http://www.sensor-ic.com/> TEL: (0755-83376489) FAX: 0755-83376182 E-MAIL: szss20@163.com

www.eoc-inc.com