

Features and Benefits

- ❑ Wide operating voltage range: from 2.7V to 24V
- ❑ Very wide range for magnetic sensitivity
- ❑ Chopper-stabilized amplifier stage
- ❑ Programmable Built-in negative temperature coefficient
- ❑ Reverse Supply Voltage Protection
- ❑ Under-Voltage Lockout Protection
- ❑ Thermal Protection
- ❑ High ESD rating / Excellent EMC performance

Application Examples

- ❑ Automotive, Consumer and Industrial
- ❑ Wiper motor
- ❑ Window lifter
- ❑ Doorlock
- ❑ Seatbelt buckle
- ❑ Seat positioning
- ❑ Sunroof/Tailgate opener
- ❑ Electrical power steering

Ordering Information

Part No.	Temperature Code	Package Code	Comment
MLX92241LUA-AAA-003-BU	L (-40°C to 150°C)	UA (TO92-3L)	BU (Bulk) - ALNS

1 Functional Diagram

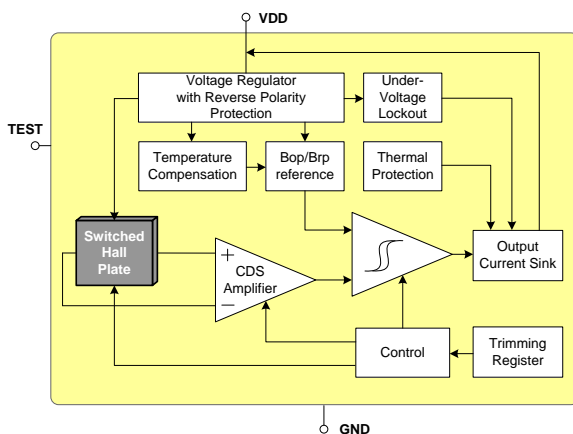

2 General Description

The Melexis MLX92241 is the new generation Hall-effect switch designed in mixed signal submicron CMOS technology.

The device integrates a voltage regulator, Hall sensor with advanced offset cancellation system and a current sink-configured output driver, all in a single package.

Based on a brand new platform, the magnetic core is using an improved offset cancellation system allowing faster and more accurate processing while being temperature insensitive and stress independent. In addition a temperature coefficient is implemented to compensate the natural behaviour of certain types of magnets becoming weaker with rise in temperature.

The included voltage regulator operates from 2.7 to 24V, hence covering a wide range of applications. With the built-in reverse voltage protection, a serial resistor or diode on the supply line is not required so that even remote sensors can be specified for low voltage operation down to 2.7V while being reverse voltage tolerant.

In an event of a drop below the minimum supply voltage during operation, the under-voltage lock-out protection will automatically freeze the device, preventing the electrical perturbation to affect the magnetic measurement circuitry. The output current state is therefore only updated based on a proper and accurate magnetic measurement result.

The two-wire interface not only saves one wire, but also allows implementation of diagnostic functions as reverse polarity connection and malfunction detection. The on-chip thermal protection also switches off the output if the junction temperature increases above an abnormally high threshold. It will automatically recover once the temperature decreases below a safe value.

With switching magnetic characteristics the supply current state is turned high by a sufficiently strong South Pole facing the package branded side. Toggling the state of the supply current from high to low is possible by applying low or no magnetic field.

The MLX92241 is delivered in a Green and RoHS compliant Plastic Single-in-Line (TO-92 flat) for through-hole mount or PCB-less design or in 3-pin Thin Small Outline Transistor (TSOT) for surfacemount process



MLX92241LUA-AAA-003

2-Wire Hall Effect Switch

Table of Contents

1 Functional Diagram	1
2 General Description	1
3 Absolute Maximum Ratings	3
4 General Electrical Specifications	4
5 Magnetic Specifications	5
6 Magnetic Behaviour	5
6.1 Unipolar Switch sensor	5
7 Performance Graphs	6
7.1 B_{OP} and B_{RP} vs. T_J	6
7.2 B_{OP} and B_{RP} vs. V_{DD}	6
7.3 I_{OFF} vs. T_J	6
7.4 I_{OFF} vs. V_{DD}	6
7.5 I_{ON} vs. T_J	6
7.6 I_{ON} vs V_{DD}	6
7.7 V_{DD} derating UA package	7
8 Application Information	8
8.1 Typical Automotive Application Circuit	8
8.2 Automotive and Harsh, Noisy Environments Application Circuit	8
8.3 Strobbing V_{DD} application (used for reduced self-heating)	8
9 Standard information regarding manufacturability of Melexis products with different soldering processes	9
10 ESD Precautions	9
11 UA (TO92 - 3L) Package Information	10
12 Disclaimer	11



MLX92241LUA-AAA-003

2-Wire Hall Effect Switch

3 Absolute Maximum Ratings

Parameter	Symbol	Value	Units
Supply Voltage ^(1, 2)	V_{DD}	+27V	V
Supply Current ^(1, 2, 3)	I_{DD}	+20	mA
Supply Current ^(1, 4, 3)	I_{DD}	+50	mA
Reverse Supply Voltage ^(1, 2)	V_{DDREV}	-24	V
Reverse Supply Current ^(1, 2, 5)	I_{DDREV}	-20	mA
Reverse Supply Current ^(1, 4, 5)	I_{DDREV}	-50	mA
Maximum Junction Temperature ⁽⁶⁾	T_J	+165	°C
ESD Sensitivity – HBM ⁽⁷⁾	-	3000	V
ESD Sensitivity – MM ⁽⁸⁾	-	400	V
ESD Sensitivity – CDM ⁽⁹⁾	-	1000	V
Magnetic Flux Density	B	Unlimited	mT

Exceeding the absolute maximum ratings may cause permanent damage. Exposure to absolute-maximum-rated conditions for extended periods may affect device reliability.

¹ The maximum junction temperature should not be exceeded

² For maximum 1 hour

³ Including current through protection device

⁴ For maximum 500ms

⁵ Through protection device

⁶ For 1000 hours.

⁷ Human Model according AEC-Q100-002 standard

⁸ Machine Model according AEC-Q100-003 standard

⁹ Charged Device Model according AEC-Q100-011 standard



MLX92241LUA-AAA-003

2-Wire Hall Effect Switch

4 General Electrical Specifications

DC Operating Parameters $V_{DD} = 3.5$ to $24V$, $T_J = -40^{\circ}C$ to $165^{\circ}C$ (unless otherwise specified)

Parameter	Symbol	Test Conditions	Min	Typ ⁽¹⁾	Max	Units
Supply Voltage	V_{DD}	Operating	2.7	-	24	V
Start-Up Supply Current	I_{START}		1.5	-	5	mA
Power-On Time ^(2,3)	t_{ON}	$V_{DD} = 5V$, $dV_{DD}/dt > 2V/\mu s$	-	40	70	μs
Power-On State	-	Supply Current state after t_{ON} , $B = \text{null}$	I_{OFF}			-
OFF Supply Current	I_{OFF}		2	3.3	5	mA
ON Supply Current	I_{ON}		12	-	17	mA
Supply Current Rise/Fall Time	$t_{RISE/FALL}$	From 10% to 90%, no bypass capacitor	0.1	0.3	1	μs
Chopping Frequency	f_{CHOP}		260	340	-	kHz
Refresh Period	t_{PER}		-	7.5	-	μs
Delay time ⁽⁴⁾	t_D	$B > 3 \cdot B_{OP}$, Average value for 1000 successive switching events @1kHz	-	7.5	-	μs
Output Jitter (p-p)	t_{JITTER}	$B > 3 \cdot B_{OP}$, Over 1000 successive switching events @1kHz	-	± 3.3	-	μs
Maximum Switching Frequency ⁽⁵⁾	f_{SW}	$B > 3 \cdot B_{OP}$	30	50	-	kHz
Under-voltage Lockout Threshold	V_{UVL}		-	-	2.7	V
Under-voltage Lockout Reaction time	t_{UVL}		-	1	-	μs
Thermal Protection Threshold	T_{SDON}	Junction temperature	-	190	-	$^{\circ}C$
Thermal Protection Release	T_{SDOFF}	Junction temperature	-	180	-	$^{\circ}C$
Safe Mode Supply Current	I_{TP}	Thermal Protection activated	-	-	0.8	mA
Reverse Supply Current	I_{DDREV}	$V_{DD} = -16V$			1	mA
TSOT Package Thermal Resistance	RTH	Single layer (1S) Jedec board, zero LFPM		300		$^{\circ}C/W$
UA Package Thermal Resistance	RTH	Single layer (1S) Jedec board, zero LFPM		200		$^{\circ}C/W$

¹ Typical values are defined at $T_A = +25^{\circ}C$ and $V_{DD} = 12V$

² The Power-On Time represents the time from reaching $V_{DD} = 2.7V$ to the first refresh of the supply current state.

³ Power-On Slew Rate should not be critical for the proper device start-up.

⁴ Delay Time is the time from magnetic threshold reached to the start of the supply current switching

⁵ Maximum switching frequency corresponds to the maximum frequency of the applied magnetic field which is detected without loss of pulses



MLX92241LUA-AAA-003

2-Wire Hall Effect Switch

5 Magnetic Specifications

DC Operating Parameters $V_{DD} = 3.5$ to $24V$, $T_J = -40^{\circ}C$ to $165^{\circ}C$ (unless otherwise specified)

Magnetic & Temperature Coefficient Option Code Combination	Test Conditions	Operating Point B_{OP} (mT)			Release Point B_{RP} (mT)			Temperature Coefficient (ppm/°C)
		Min	Typ	Max	Min	Typ	Max	Typ
High Sensitivity + NdFeB TC match	$T_J = -40^{\circ}C$	5.9	8.5	10.9	3.5	5.5	7.9	-1100
	$T_J = 25^{\circ}C$	6.1	7.9	9.5	3.9	5.3	7.0	
	$T_J = 150^{\circ}C$	3.8	6.8	9.6	2.7	5.0	8.2	

Table 1: Magnetic Switching Points & Temperature Coefficient combination

Temperature coefficient is calculated using the following formula:

$$\frac{B_{OPT2} - B_{OPT1}}{B_{OP25^{\circ}C}} \times \frac{1}{T_2 - T_1} * 10^6, ppm/^{\circ}C; T_1 = 25^{\circ}C; T_2 = 150^{\circ}C$$

6 Magnetic Behaviour

6.1 Unipolar Switch sensor

Parameter	Pole Active	Magnetic Polarity	Remark
Option 1	South	Direct	Fig.1

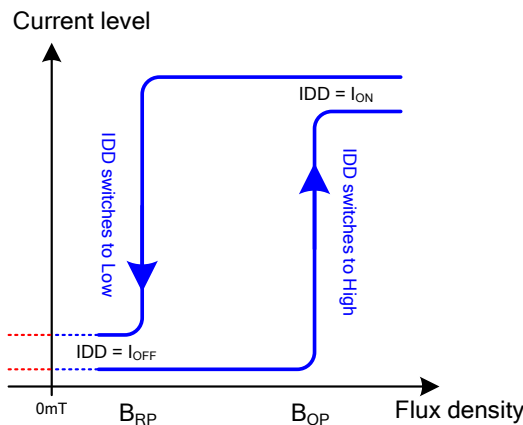

Fig.1 – Direct South Pole Active



MLX92241LUA-AAA-003

2-Wire Hall Effect Switch

7 Performance Graphs

7.1 B_{OP} and B_{RP} vs. T_J

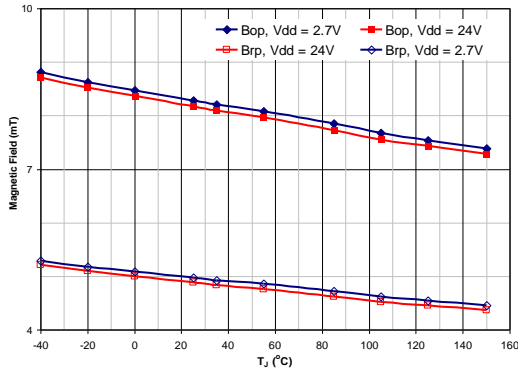

7.2 B_{OP} and B_{RP} vs. V_{DD}

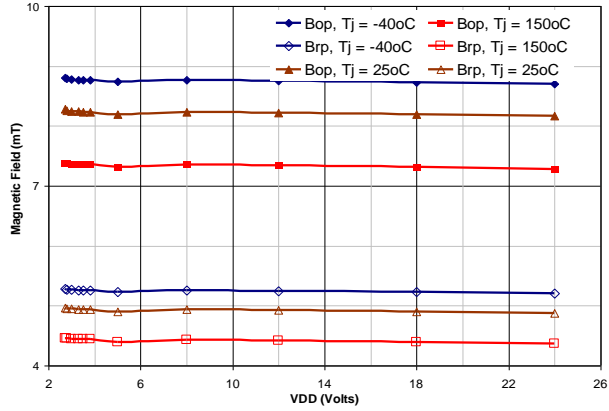

7.3 I_{OFF} vs. T_J

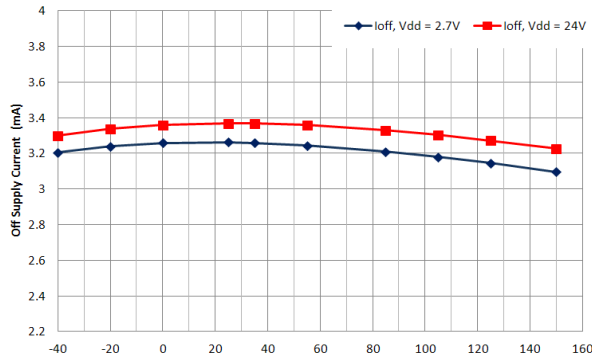

7.4 I_{OFF} vs. V_{DD}

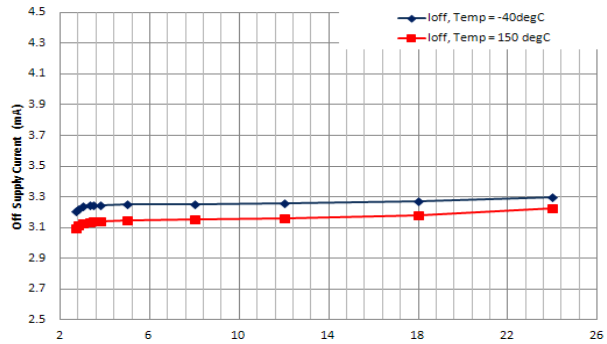

7.5 I_{ON} vs. T_J

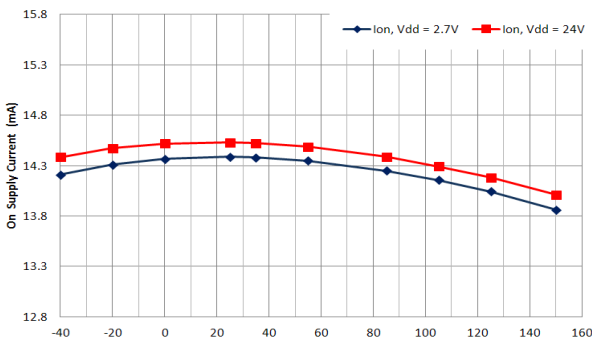

7.6 I_{ON} vs. V_{DD}

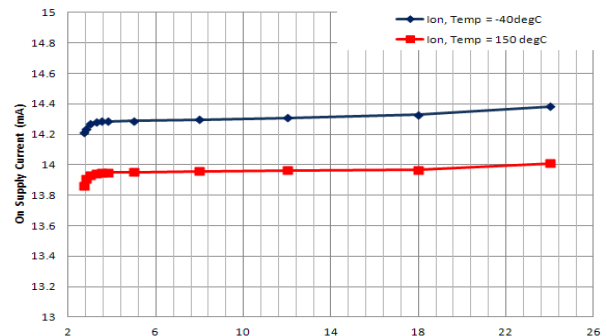



MLX92241LUA-AAA-003

2-Wire Hall Effect Switch

7.7 VDD derating UA package

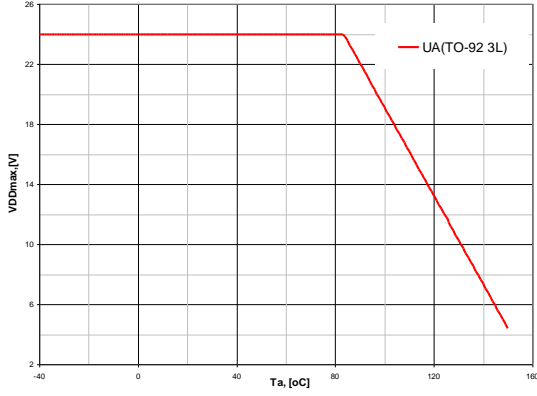



MLX92241LUA-AAA-003

2-Wire Hall Effect Switch

8 Application Information

8.1 Typical Automotive Application Circuit

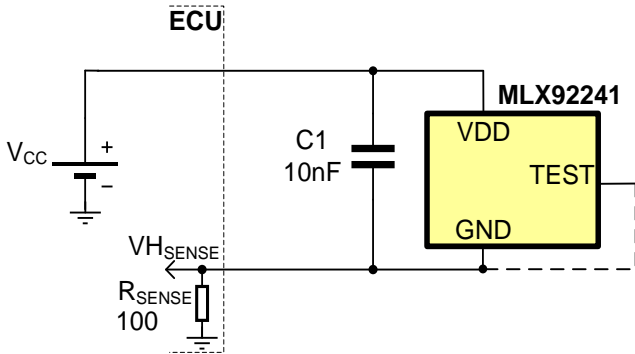

Notes:

1. For proper operation, a 10nF bypass capacitor should be placed as close as possible to the V_{DD} and ground(GND) pin. For complete emissions protection a C1 = 68nF is recommended.
2. The TEST pin is to be left open or connected to GND.

8.2 Automotive and Harsh, Noisy Environments Application Circuit

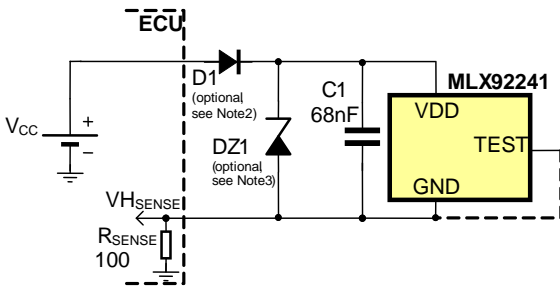

Notes:

1. For proper operation, a 10nF to 100nF bypass capacitor should be placed as close as possible to the V_{DD} and ground pin.
2. The device could tolerate negative voltage down to -24V, so if negative transients over supply line V_{PEAK} < -29V are expected, usage of the diode D1 is recommended. Otherwise only R_{SENSE} is sufficient.

When selecting the resistor R_{SENSE}, three points are important:

- the resistor has to limit I_{DD}/I_{DDREV} to 50mA maximum
- the resistor has to withstand the power dissipated in both over voltage conditions (V_{SENSE}²/R_{SENSE})
- the resulting device supply voltage V_{DD} has to be higher than V_{DDmin}

$$(V_{DD} = V_{CC} - R_{SENSE} \cdot I_{DD})$$

3. The device could tolerate positive supply voltage up to +27V (until the maximum power dissipation is not exceeded), so if positive transients over supply line with V_{PEAK} > 32V are expected, usage a zener diode DZ1 is recommended. The R_{SENSE} DZ1 network should be sized to limit the voltage over the device below the maximum allowed.

8.3 Strobing VDD application (used for reduced self-heating)

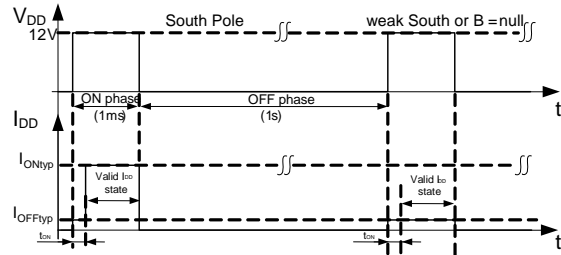
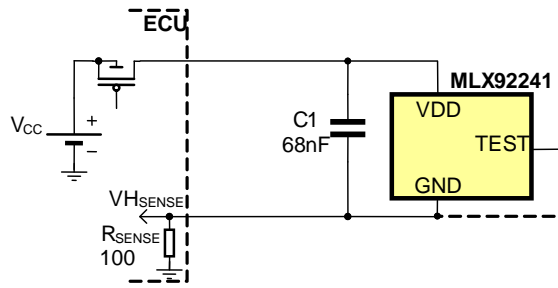

Notes:

1. Given strobe timing is exemplary only. The output response is for sensor type MLX92221xxx-xLxS.
2. For proper operation, a 10nF to 100nF bypass capacitor should be placed as close as possible to the V_{DD} and ground pin.



MLX92241LUA-AAA-003

2-Wire Hall Effect Switch

9 Standard information regarding manufacturability of Melexis products with different soldering processes

Our products are classified and qualified regarding soldering technology, solderability and moisture sensitivity level according to following test methods:

Reflow Soldering SMD's (Surface Mount Devices)

- IPC/JEDEC J-STD-020
Moisture/Reflow Sensitivity Classification for Nonhermetic Solid State Surface Mount Devices (classification reflow profiles according to table 5-2)
- EIA/JEDEC JESD22-A113
Preconditioning of Nonhermetic Surface Mount Devices Prior to Reliability Testing (reflow profiles according to table 2)

Wave Soldering SMD's (Surface Mount Devices) and THD's (Through Hole Devices)

- EN60749-20
Resistance of plastic- encapsulated SMD's to combined effect of moisture and soldering heat
- EIA/JEDEC JESD22-B106 and EN60749-15
Resistance to soldering temperature for through-hole mounted devices

Iron Soldering THD's (Through Hole Devices)

- EN60749-15
Resistance to soldering temperature for through-hole mounted devices

Solderability SMD's (Surface Mount Devices) and THD's (Through Hole Devices)

- EIA/JEDEC JESD22-B102 and EN60749-21
Solderability

For all soldering technologies deviating from above mentioned standard conditions (regarding peak temperature, temperature gradient, temperature profile etc) additional classification and qualification tests have to be agreed upon with Melexis.

The application of Wave Soldering for SMD's is allowed only after consulting Melexis regarding assurance of adhesive strength between device and board.

<http://www.melexis.com/Assets/Soldering-Application-Note-and-Recommendations-5446.aspx>

Melexis is contributing to global environmental conservation by promoting **lead free** solutions. For more information on qualifications of **RoHS** compliant products (RoHS = European directive on the Restriction Of the use of certain Hazardous Substances) please visit the quality page on our website: <http://www.melexis.com/quality.aspx>

10 ESD Precautions

Electronic semiconductor products are sensitive to Electro Static Discharge (ESD).

Always observe Electro Static Discharge control procedures whenever handling semiconductor products.



MLX92241LUA-AAA-003

2-Wire Hall Effect Switch

11 UA (TO92 - 3L) Package Information

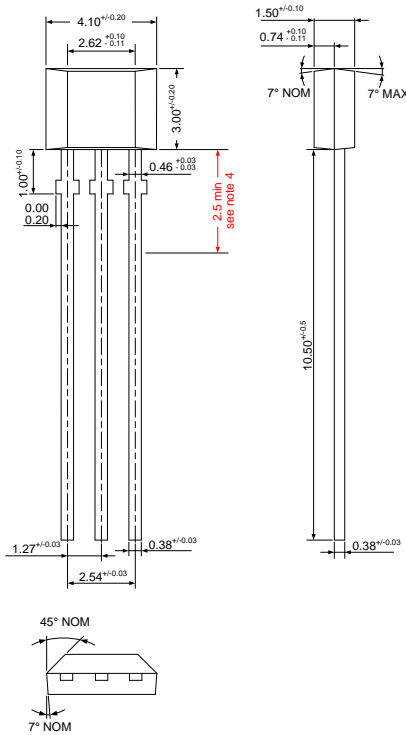

- Notes:**
1. All dimensions are in millimeters
 2. Package dimension exclusive molding flash.
 3. The end flash shall not exceed 0.127 mm on each side.
 4. To preserve reliability, it is recommended to have total lead length equal to 2.5mm minimum, measured from the package line.

- Marking:**
- 1st Line : xxx – last three digits from lot number
 2nd Line : yww
 y - last digit of year
 ww - calendar week

Hall plate location

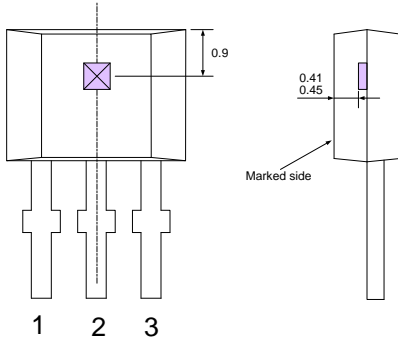

- Notes:**
1. All dimensions are in millimeters

SE Pin №	Name	Type	Function
1	VDD	Supply	Supply Voltage pin
2	GND	Ground	Ground pin
3	TEST	I/O	Analog & Digital I/O



MLX92241LUA-AAA-003

2-Wire Hall Effect Switch

12 Disclaimer

Devices sold by Melexis are covered by the warranty and patent indemnification provisions appearing in its Term of Sale. Melexis makes no warranty, express, statutory, implied, or by description regarding the information set forth herein or regarding the freedom of the described devices from patent infringement. Melexis reserves the right to change specifications and prices at any time and without notice. Therefore, prior to designing this product into a system, it is necessary to check with Melexis for current information. This product is intended for use in normal commercial applications. Applications requiring extended temperature range, unusual environmental requirements, or high reliability applications, such as military, medical life-support or life-sustaining equipment are specifically not recommended without additional processing by Melexis for each application.

The information furnished by Melexis is believed to be correct and accurate. However, Melexis shall not be liable to recipient or any third party for any damages, including but not limited to personal injury, property damage, loss of profits, loss of use, interrupt of business or indirect, special incidental or consequential damages, of any kind, in connection with or arising out of the furnishing, performance or use of the technical data herein. No obligation or liability to recipient or any third party shall arise or flow out of Melexis' rendering of technical or other services.

© 2012 Melexis NV. All rights reserved.

For the latest version of this document, go to our website at
www.melexis.com

Or for additional information contact Melexis Direct:

Europe, Africa:	Americas:	Asia:
Phone: +32 1367 0495	Phone: +1 248-306-5400	Phone: +32 1367 0495
E-mail: sales_europe@melexis.com	E-mail: sales_usa@melexis.com	E-mail: sales_asia@melexis.com

ISO/TS 16949 and ISO14001 Certified