

ML2502 Demo Board

1999.03.19 ver1.0

INSTRUCTION MANUAL

PRELIMINARY version

GENERAL DESCRIPTION

The ML2502 demonstration board is intended as a familiarisation and demonstration tool to help design-in the ML2502 analog storage recorder LSI.

BOARD LAYOUT

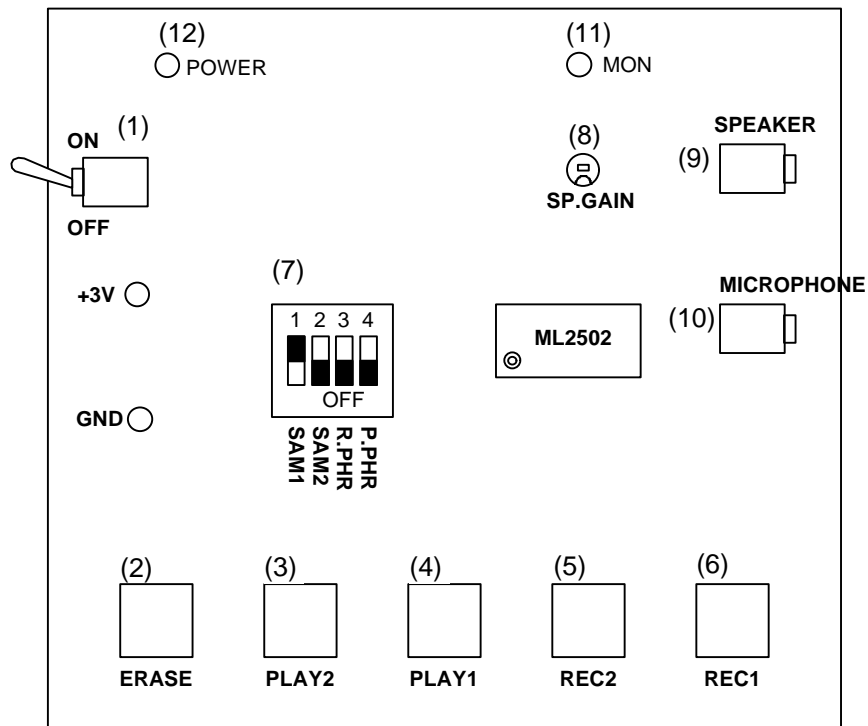

SWITCHES DESCRIPTION

- (1) POWER Turn on the POWER and LED (12).
- (2) ERASE Erase – enable signal input switch, used together with the REC1 (6) and/or the REC2 (5).
- (3) PLAY2 Input start-playback signal for Phrase 2 to this switch.
- (4) PLAY1 Input start-playback signal for Phrase 1 to this switch.
- (5) REC2 Input start-recording signal for Phrase 2 to this switch.
- (6) REC1 Input start-recording signal for Phrase 1 to this switch.

(7) SAM2, SAM1, R.PHR, and P.PHR

SAM2 and SAM1 switches are used to select a sampling frequency.

SAM2	L	L	H	H
SAM1	L	H	L	H
Fsam (kHz)	4.0	5.3	6.4	Disable

The Board Layout shows that SAM2 is “L” and SAM1 is “H”, and shows 5.3 kHz is set.

P.PHR switch is used to select Dual Phrase Playback-mode or Single Phrase Playback-mode. The Board Layout shows that P.PHR is “L”, and shows the Dual Phrase Playback-mode is set.

R.PHR switch is used to select Dual Phrase Recording-mode or Single Phrase Recording-mode. The Board Layout shows that R.PHR is “L”, and shows the Dual Phrase Recording-mode is set.

(8) SP.GAIN

When Turn right, the volume is increase.

(9) SPEAKER

Connect the speaker.

(10) MICROPHONE

Connect the microphone.

(11) MON

During recording and playback, turn on the LED.

RECORD and PLAYBACK OPERATION

ML2502 has two record/playback modes, Dual-phrase record/playback mode and Single-phrase record/playback mode. While in Dual-phrase record/playback mode the total memory space is divided evenly into two areas for 2-phrase record/playback, the entire memory space is used for one phrase record/playback in Single-phrase record/playback mode.

In Dual-phrase record/playback mode the first half of the memory, i.e. from the top address up to the center address, is assigned to Phrase 1, and the second half, i.e. from the center address to the last address, is assigned to Phrase 2. Record/playback of

Phrase 1 can be controlled via the REC1 and PLAY1 pins, while Phrase 2 can be controlled via the REC2 and PLAY2 pins respectively.

In Single-phrase mode record/playback must be performed with the REC1 being connected to the REC2 pin and the PLAY1 being connected to the PLAY2 pin respectively.

In both playback modes repetitive playback function for the same phrase is available.

1. Dual-Phrase Record/Playback Mode

1-1. Phrase 1 Recording Operation

- (1) Keep on inputting “H” level to the REC1 pin to power up and start recording from the top address of the memory. Recording goes on while the REC1 pin being held “H” level.
- (2) The LSI automatically ends recording when the center address has been reached.
- (3) The LSI automatically shifts to low-power consumption mode after recording ends.
- (4) To stop recording for phrase 1 before reaching the center address, bring the REC1 pin down to “L” level. The LSI automatically shifts to low-power consumption mode after recording stops.
- (5) During recording operation any signal input to other pins than the REC1 is disregarded.

Note: Re-recording always causes to overwrite the existing recording data for a given phrase.

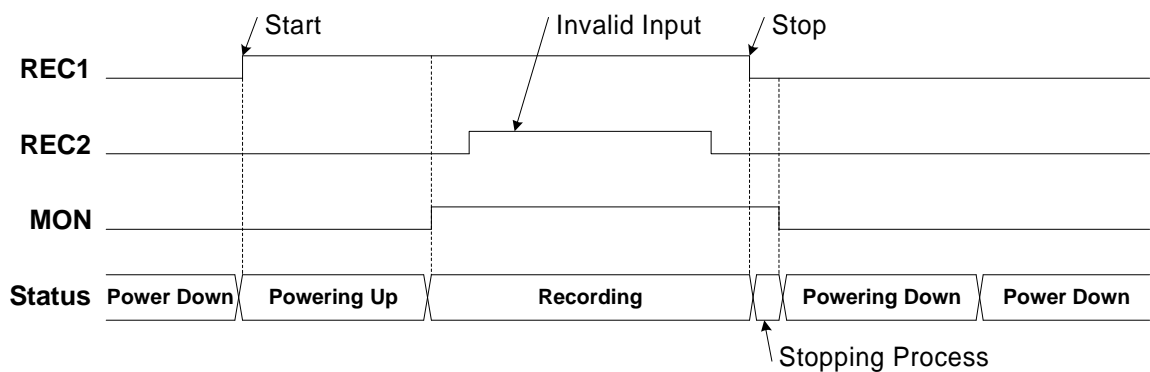

Figure 1.1 Timing Chart for Phrase 1 Recording Operation

1-2. Phrase 1 Playback Operation

- (1) Input a “H” pulse to the PLAY1 pin to power up and start playback from the top address of the memory.
- (2) The LSI automatically ends playback when the last address of the recorded phrase has been reached.
- (3) The LSI automatically shifts to low-power consumption mode after playback ends.
- (4) To stop playback of phrase 1 before reaching the last address, input a “H” pulse again to the PLAY1 or PLAY2 pin. This will cause the LSI to stop playback and then automatically shift to low-power consumption mode.
- (5) During playback operation signal input to the PLAY1 or PLAY2 pin only is valid, any other signal input is disregarded

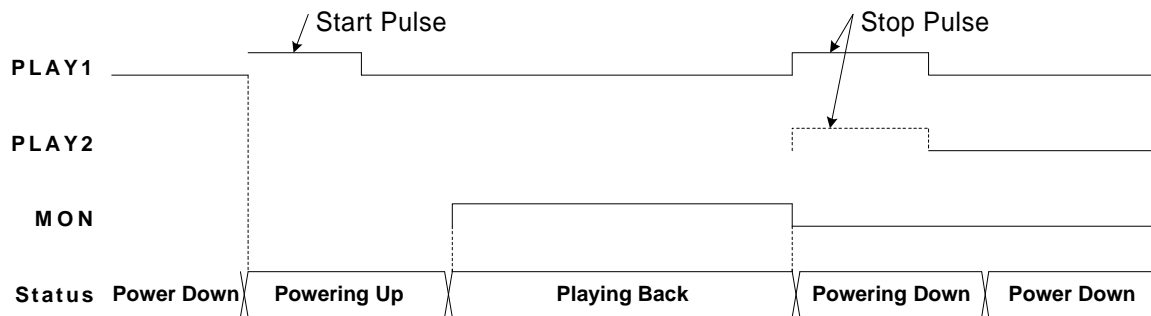

Figure 1.2 Timing Chart for Phrase 1 Playback Operation

1-3. Phrase 1 Erasing Operation

- (1) While inputting “H” level to the ERASE pin, input a “H” pulse to the REC1 pin to start erasing Phrase 1.
- (2) After Phrase 1 having been erased, the LSI automatically shifts to power-down mode for low-power consumption.

Note: Erasing operation cannot be abandoned in the middle once getting started.

Internally, the LSI performs erasing Phrase 1 by recording “Silence” from the top address to address 250. Therefore, if you attempt to playback the erased phrase, the playback starts at the top address of the memory and ends at address 250.

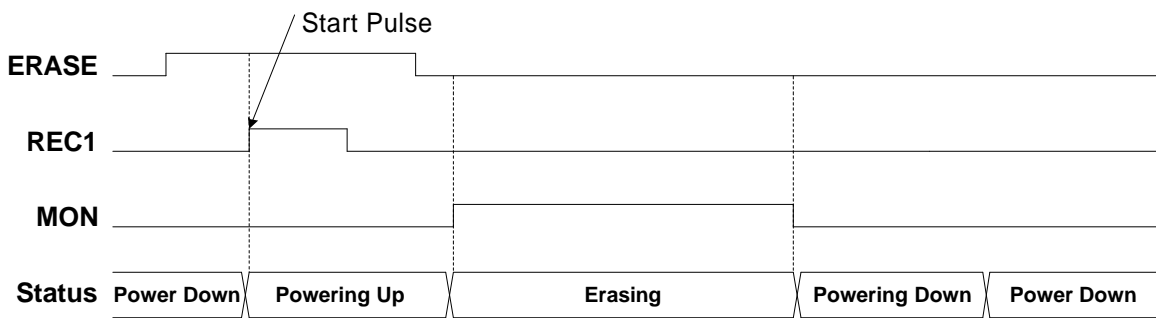

Figure 1.3 Timing Chart for Phrase 1 Erasing Operation

1-4. Phrase 2 Recording Operation

- (1) Keep on inputting “H” level to the REC2 pin to power up and start recording from the top address of the memory. Recording goes on while the REC2 pin being held “H” level.
- (2) The LSI automatically ends recording when the last address of the memory has been reached.
- (3) The LSI automatically shifts to low-power consumption mode after recording ends.
- (4) To stop recording for Phrase 2 before reaching the last address, bring the REC2 pin down to “L” level. The LSI automatically shifts to low-power consumption mode after recording stops.
- (5) During recording operation any signal input to other pins than the REC2 is disregarded.

Note: Re-recording always causes to overwrite the existing recording data for a given phrase.

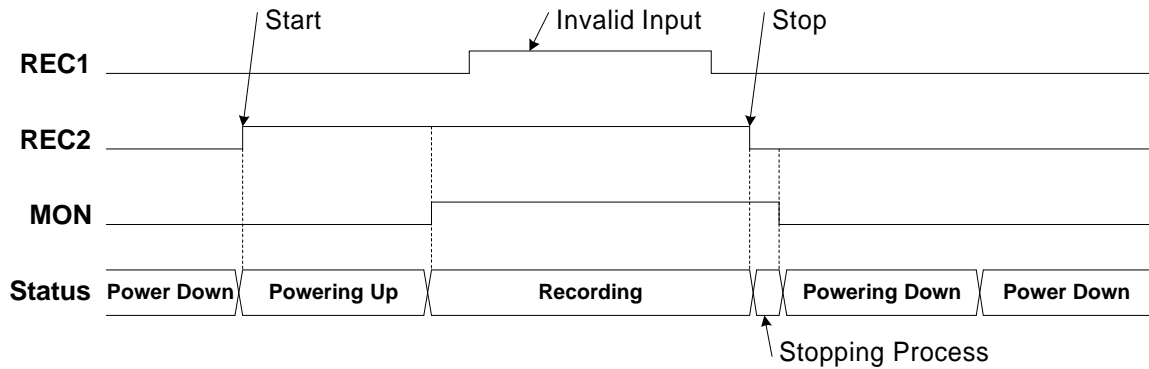

Figure 1.4 Timing Chart for Phrase 2 Recording Operation

1-5. Phrase 2 Playback Operation

- (1) Input a “H” pulse to the PLAY2 pin to power up and start playback from the center address of the memory.
- (2) The LSI automatically ends playback when the last address of the recorded phrase has been reached.
- (3) The LSI automatically shifts to low-power consumption mode after playback ends.
- (4) To stop playback of Phrase 2 before reaching its last address, input a “H” pulse again to the PLAY1 or PLAY2 pin. This will cause the LSI to stop playback and then automatically shift to low-power consumption mode.
- (5) During playback operation signal input to the PLAY1 or PLAY2 pin only is valid, any other signal input is disregarded

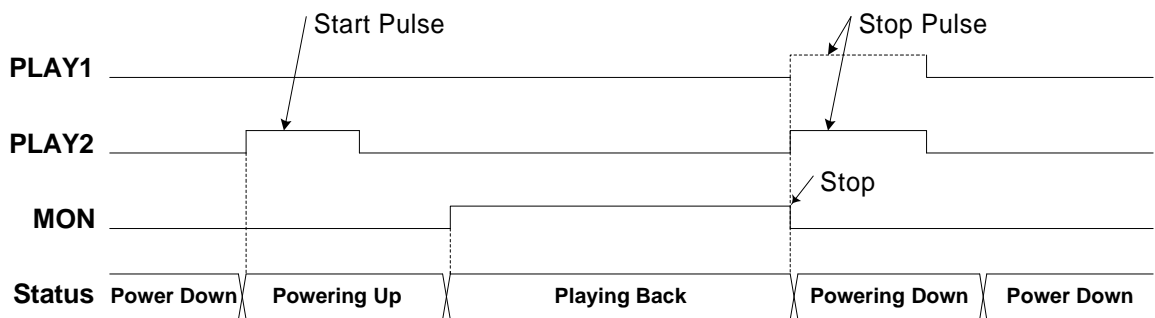

Figure 1.5 Timing Chart for Phrase 2 Playback Operation

1.6 Phrase 2 Erasing Operation

- (1) While inputting “H” level to the ERASE pin, input a “H” pulse to the REC2 pin to start erasing Phrase 2.

- (2) After Phrase 2 having been erased, the LSI automatically shifts to power-down mode for low-power consumption.

Note: Erasing operation cannot be abandoned in the middle once getting started.

Internally, the LSI performs erasing Phrase 2 by recording “Silence” from the center address as far as to address 250. Therefore, if you attempt to playback the erased phrase, the playback starts at the center address of the memory and ends at address 250.

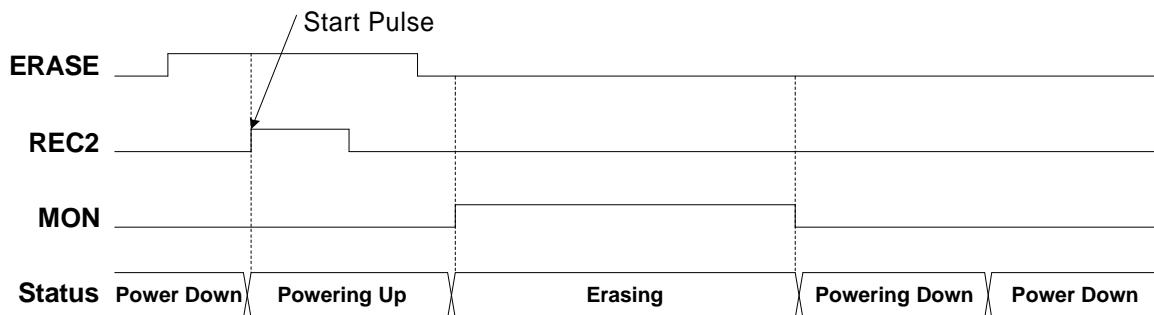

Figure 1.6 Timing Chart for Phrase 2 Erasing Operation

2. Single-phrase Record/Playback Mode

2-1. Recording Operation

- (1) In this mode the REC1 has to be connected with the REC2 pin.
Keep on inputting “H” level to the REC1 and the REC2 pin to power up and start recording from the top address of the memory. Recording goes on while the REC1 and the REC2 pin being held at “H” level.
- (2) The LSI automatically ends recording when the last address of the memory has been reached.
- (3) The LSI automatically shifts to low-power consumption mode after recording ends.
- (4) To stop recording before reaching the last address, bring the REC1 and the REC2 pin down to “L” level. The LSI automatically shifts to low-power consumption mode after recording stops.
- (5) During recording operation any signal input to other pins than the REC1 and the REC2 is disregarded.

Note: Re-recording always causes to overwrite the existing recording data for a given phrase.

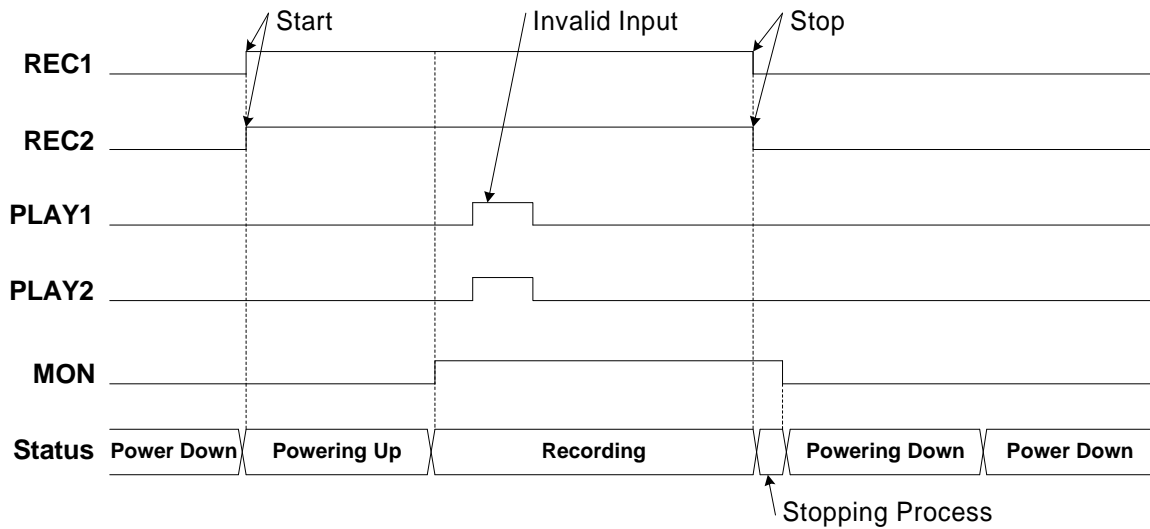

Figure 2.1 Timing Chart for Single-phrase Recording Operation

2-2. Playing Back Operation

- (1) Input “H” pulses to the PLAY1 and the PLAY2 pins simultaneously to power up and start playback from the top address of the memory.
- (2) The LSI automatically ends playback when the last address of the recorded phrase has been reached.
- (3) The LSI automatically shifts to low-power consumption mode after playback ends.
- (4) To stop playback of the phrase before reaching its last address, input “H” pulses again to the PLAY1 and the PLAY2 pins simultaneously. This will cause the LSI to stop playback and then automatically shift to low-power consumption mode.
- (5) During playback operation signal input to the PLAY1 or PLAY2 pin only is valid, any other signal input is disregarded.

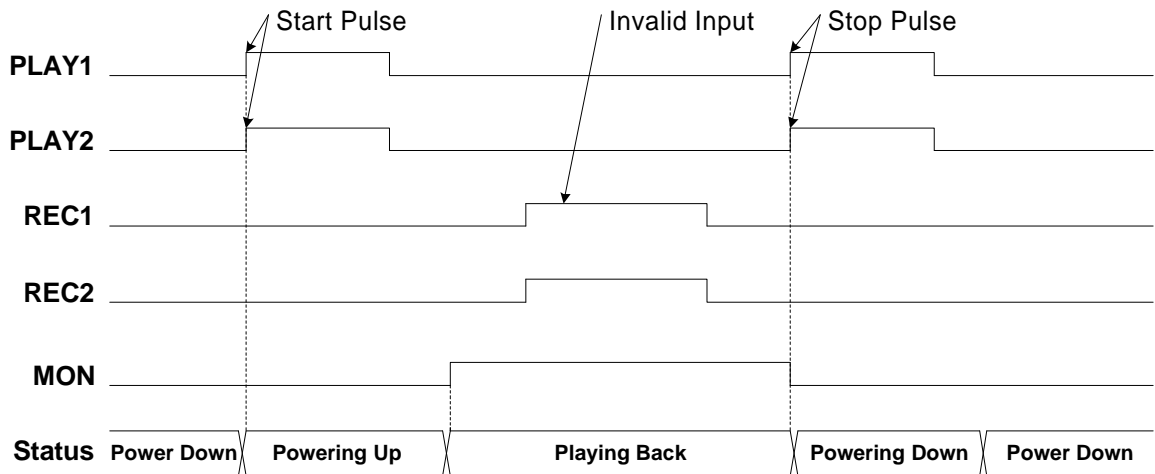

Figure 2.2 Timing Chart for Single-phrase Playback Operation

2-3. Erasing the Phrase 2

- (1) While inputting "H" level to the ERASE pin, input "H" pulses to the REC1 and REC2 pins simultaneously to start erasing the phrase.
- (2) After the phrase having been erased, the LSI automatically shifts to power-down mode for low-power consumption.

Note: Erasing operation cannot be abandoned in the middle once getting started.

Internally, the LSI performs erasing by recording "Silence" from the top address as far as to address 250. Therefore, if you attempt to playback the erased phrase, the playback starts at the top address of the memory and ends at address 250.

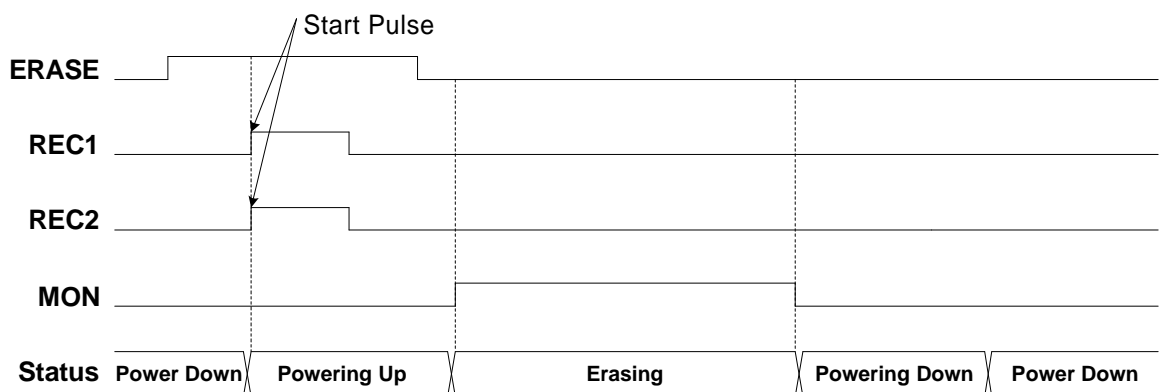

Figure 2.3 Timing Chart for Single-phrase Erasing Operation.

3. Repeating Playback Operation

- (1) To repeat playback of the same phrase, keep on inputting “H” level to the PLAY1 or PLAY2 pin. “H” level input to the PLAY1 or PLAY2 causes the LSI to power up and start playback.
- (2) The LSI automatically restarts playback when the last address of the phrase has been reached.
- (3) When the playback reaches to the last address of the phrase, with the PLAY1 or PLAY2 pin being held “L” level, the LSI automatically ends playback.
- (4) The LSI automatically powers down after playback ends.
- (5) To stop playback before repetitive playback session ends, bring the PLAY1 or PLAY2 pin down to “L” level once, and then re-input a “H” pulse to the PLAY1 or PLAY2 pin. The LSI automatically shifts to low-power consumption mode after playback stops.

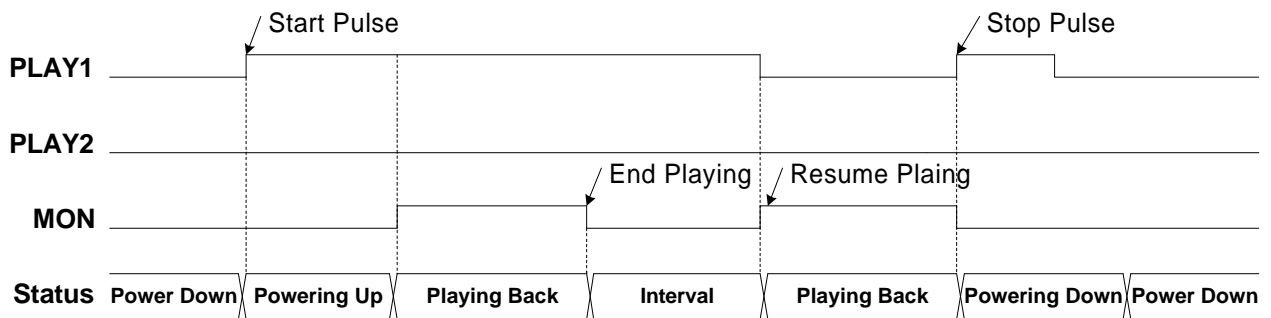

Figure 3.1 Timing Chart for Repetitive Playback Operation

CIRCUIT DIAGRAM

