

OKI electronic components

OCM2□4, 2□5 SERIES

Low Output-capacitance Type Optical MOS Relay For AC/DC Load

GENERAL DESCRIPTION

The OCM2□4 and OCM2□5 Series are optical MOS relays for AC/DC load that provide high-speed response and are capable of handling high-frequency signals. The input portion is an infrared light emitting diode. The output portion uses a combination of low-capacitance VD-MOS (Vertical Diffusion MOS) FETs and photodiode arrays. The device is encased in an extremely small 6-pin plastic DIP or SMD-type (gull-wing) package.

The optical MOS relay switch may be used in applications that currently use mechanical relay switches, but offers smaller size, noise-free switching, and electronic circuit compatibility because of its non-mechanical operation. Optical MOS relay switches also dissipate less power than equivalent bipolar devices at lower switching frequencies.

FEATURES

- Infinitesimally small control voltage
- Excellent high-frequency characteristics (>30 dB isolation at 10 MHz)
- High-speed switching response of 200 μs or less
- Low leakage current
- No chattering or switch bounces
- No mechanical switching noises
- Small size and easy mounting (6-pin plastic DIP or SMD-type[gull-wing] package)

APPLICATIONS

- Measurement equipment
- Audio-visual equipment
- Home electronics
- Automatic meter reading equipment
- Other applications requiring small size or high performance
- Other applications requiring non-contact switches

PIN CONFIGURATION

(Unit: mm)

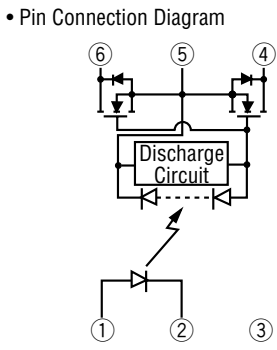
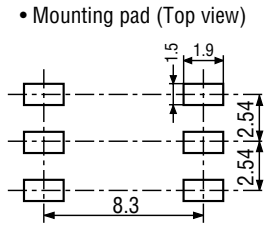
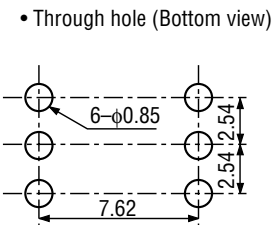
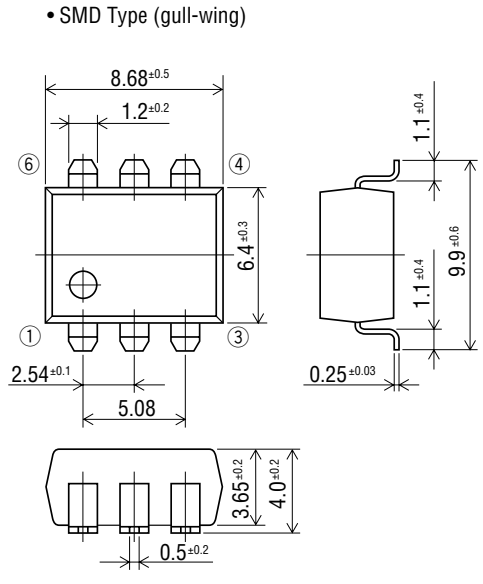
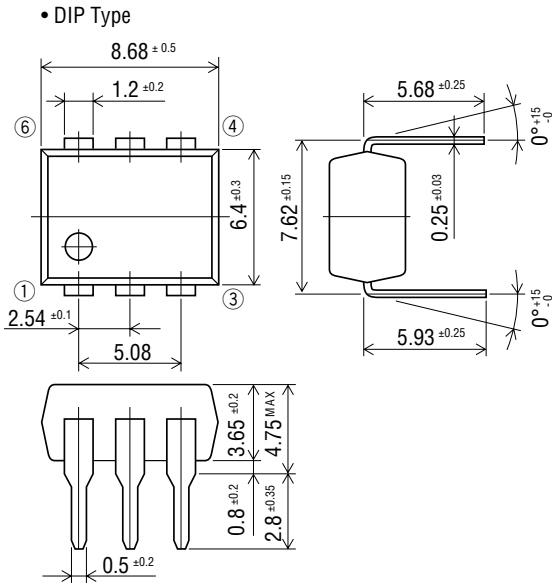

- 1: Anode (LED)
- 2: Cathode (LED)
- 3: NC
- 4: Drain (MOS FET)
- 5: Source (MOS FET)
- 6: Drain (MOS FET)

ABSOLUTE MAXIMUM RATINGS

(Ambient temperature Ta=25°C)

Product Name				OCM204	OCM214	OCM224	OCM244		
Parameter	Symbol	Condition	Unit	OCM205	OCM215	OCM225	OCM245		
Input Characteristics	Continuous Forward Current	I_F		mA				50	
	Derating Factor of Continuous Forward Current	ΔI_F		mA/°C				Refer to [Derating Factor of Continuous Forward Current] of characteristics data	
	Peak Forward Current	I_{FM}	Pulse width 100 μ s Cycle 10 ms	A				0.5	
	Reverse Voltage	V_R		V				5	
	Power Dissipation	P_{DL}		mW				75	
Output Characteristics	Load Voltage	V_{OFF}		V				60 100 200 400	
	Load Current	I_{ON}		mA				80 50 40 15	
	Derating Factor of Load Current	ΔI_{ON}		mA/°C				Refer to [Derating Factor of Load Current] of characteristics data	
	Surge Load Current	I_{SUG}	Pulse width 1 ms 1shot	A		0.1	0.07	0.025	
	Power Dissipation	P_D		mW				300	
Total Power Dissipation				P_{tot}	mW				325
Isolation Voltage	V_{IO}		V(rms)	1500				OCM204 OCM214 OCM224 OCM244	
				4000					
				OCM205	OCM215	OCM225	OCM245		
Operating Temperature	T_{opr}		°C				-40 to +85		
Storage Temperature	T_{stg}		°C				-40 to +100		

ELECTRICAL CHARACTERISTICS

(Ambient temperature Ta=25°C)

Product Name					OCM204	OCM214	OCM224	OCM244				
Parameter	Symbol	Condition	Unit	OCM205	OCM215	OCM225	OCM245					
Input Characteristics	Forward Voltage	V _F	I _F =10 mA	Min.	V				1.0			
				Max.					1.3			
	Reverse Voltage	I _R	V _R =5 V	Max.	μA	10						
	Operation Input Current *1	I _{FA}	I _{ON} =100 mA	Max.	mA	5						
Recovery Input Current	I _{FR}	V _{OFF} =Rating I _{ON} =100 mA	Min.	mA	0.2							
Output Characteristics	On-resistance	R _{ON}	I _F =10 mA I _{ON} =Rating <small>Time to flow current is within one second</small>	Min.	Ω				20	40	100	300
				Typ.					30	65	150	600
				Max.					40	90	200	900
Off-state Leakage Current*2	I _{OFF}	V _{OFF} =Rating	Max.	nA	1.0							
Output Terminal Capacitance	C _{OUT}	V _{OFF} =50 V f=1 MHz	Typ.	pF	7							
Input-to-output Capacitance	C _{IO}	f=1 MHz	Typ.	pF	1.3							
Coupling Characteristics	Turn-on Time	t _{ON}	I _F =10 mA I _{ON} =	Typ.	μs				30			
				Max.					200			
	Turn-off Time	t _{OFF}	OCM204, 205: 10mA OCM214, 215: 10mA OCM224, 225: 4mA OCM244, 245: 1mA	Typ.	μs				60			
Max.	200											

*1 : Can correspond to special specification I_{FA}< 3.0 mA*2 : Can correspond to special specification I_{FA}< 0.1 nA

TYPICAL CHARACTERISTICS

- Derating Factor of Continuous Forward Current

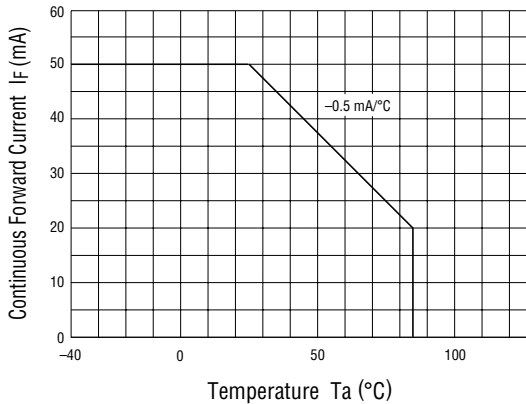

- Derating Factor of Continuous Load Current

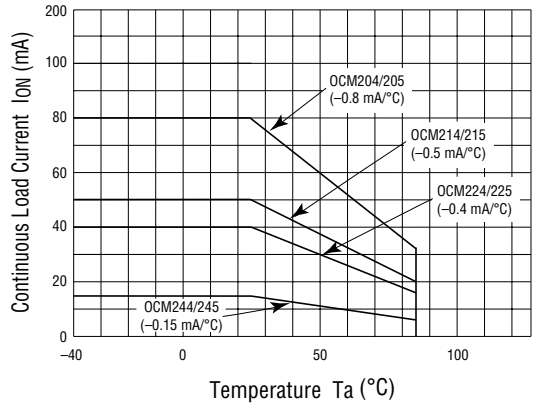

- Operation Input Current vs. Ambient Temperature

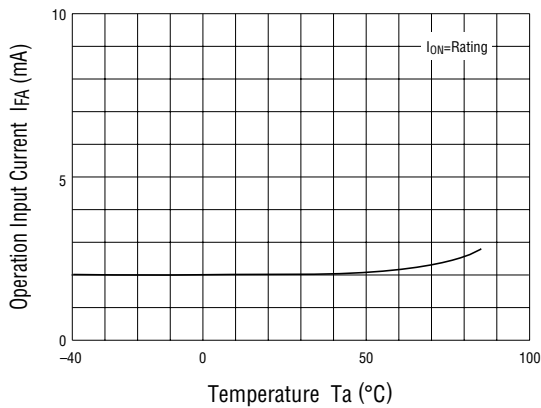

- Recovery Input Current vs. Ambient Temperature

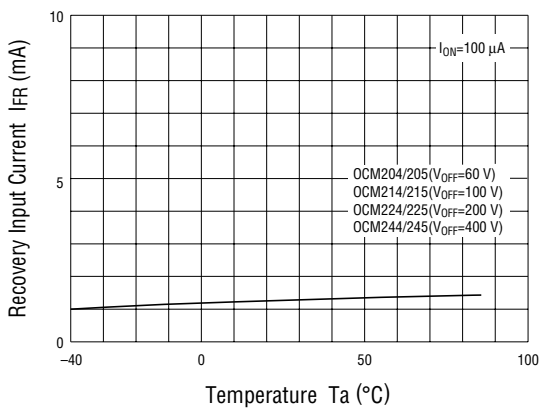

- On-resistance vs. Ambient Temperature 1

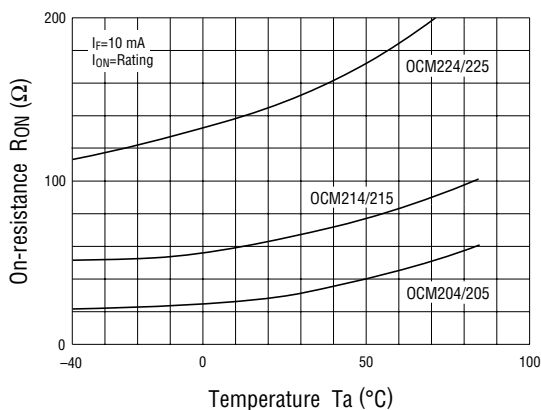

- On-resistance vs. Ambient Temperature 2

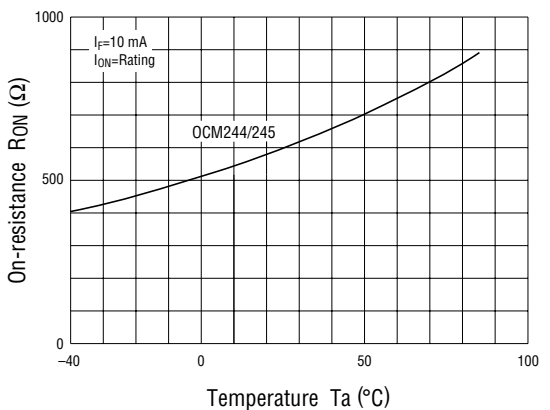

- Turn-on/Turn-off Time vs. Ambient Temperature

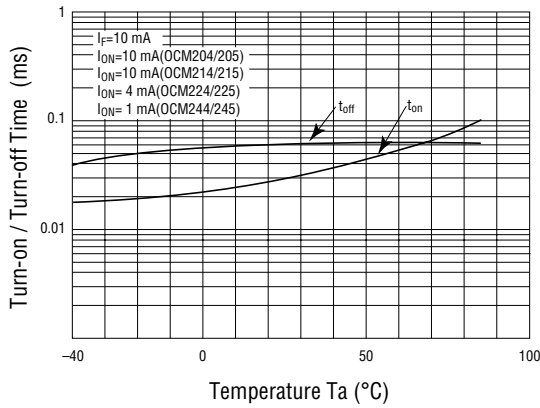

- Off-state Leakage Current vs. Ambient Temperature

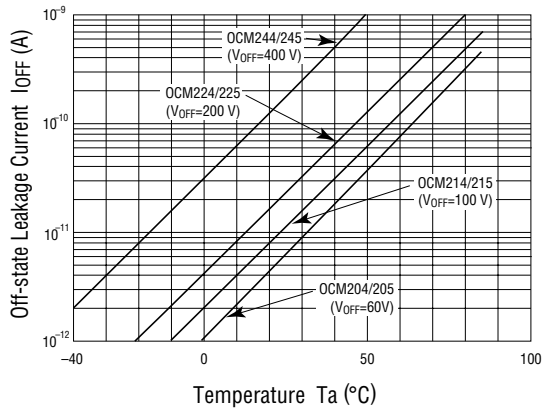

- Continuous Foward Current vs. On-resistance 1

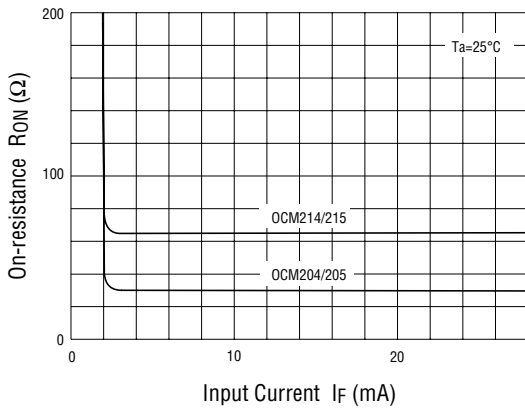

- Continuous Foward Current vs. On-resistance 2

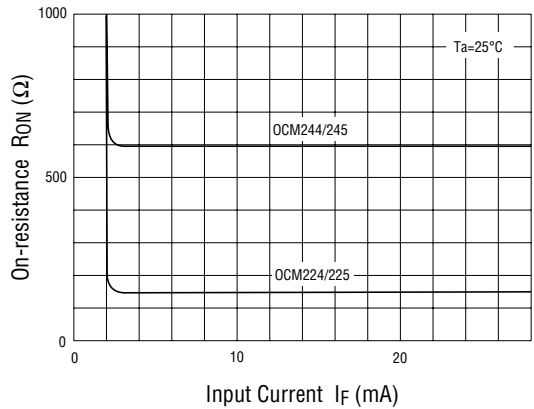

- Continuous Foward Current vs. Turn-on/Turn-off Time

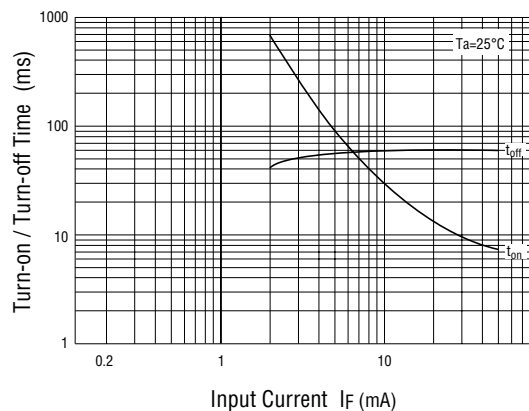

- Output Terminal Capacitance vs. Applied Voltage

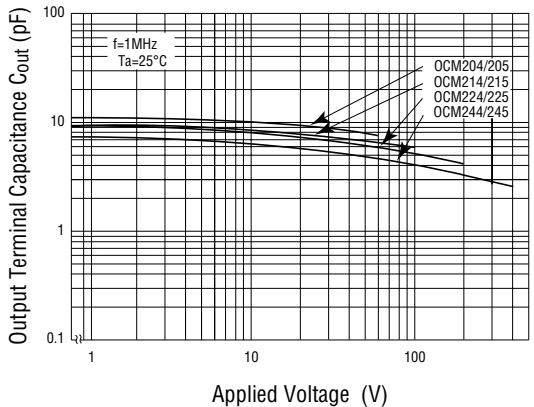

• Isolation

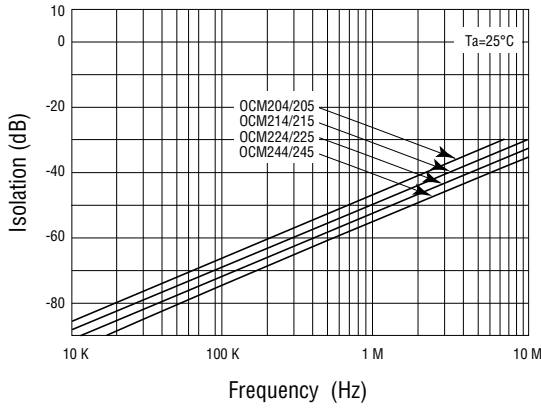

• Insertion Loss

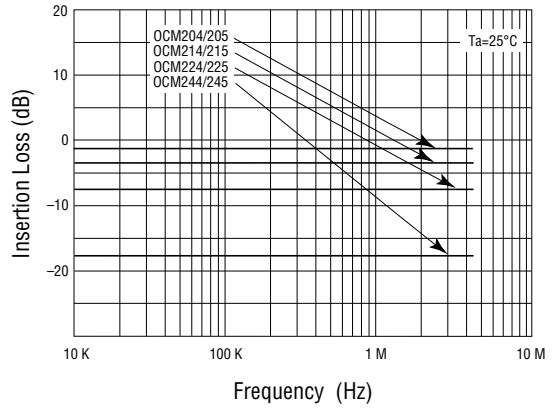

• Load Current vs. Voltage

