

Analog alarm clock with snooze

The SDL1135 series are analog clock ICs that derive their timing from a 32KHz oscillator element. They feature alarm output snooze function and alarm auto-stop function. They can be configured to match a wide variety of clock specifications, alarm functions outputs.

Features

- Single 1.5V battery operation
- 32,768 Hz crystal frequency
- Low power dissipation
- Built-in trim capacitor
- Output for 1Hz or 16Hz stepper motor with selectable pulse width
- 256 second snooze interval
- 128 second alarm output auto-stop function (Mask Option)
- Alarm outputs compatible with both electronic sound alarms and motor bells
- 4-step increasing volume alarm output
- ALIB and SNZB use different pins
- Built-in debounce circuit (ALIB/SNZB pin)
- Fast test functions
- Power-on-clear function

PAD LAYOUT

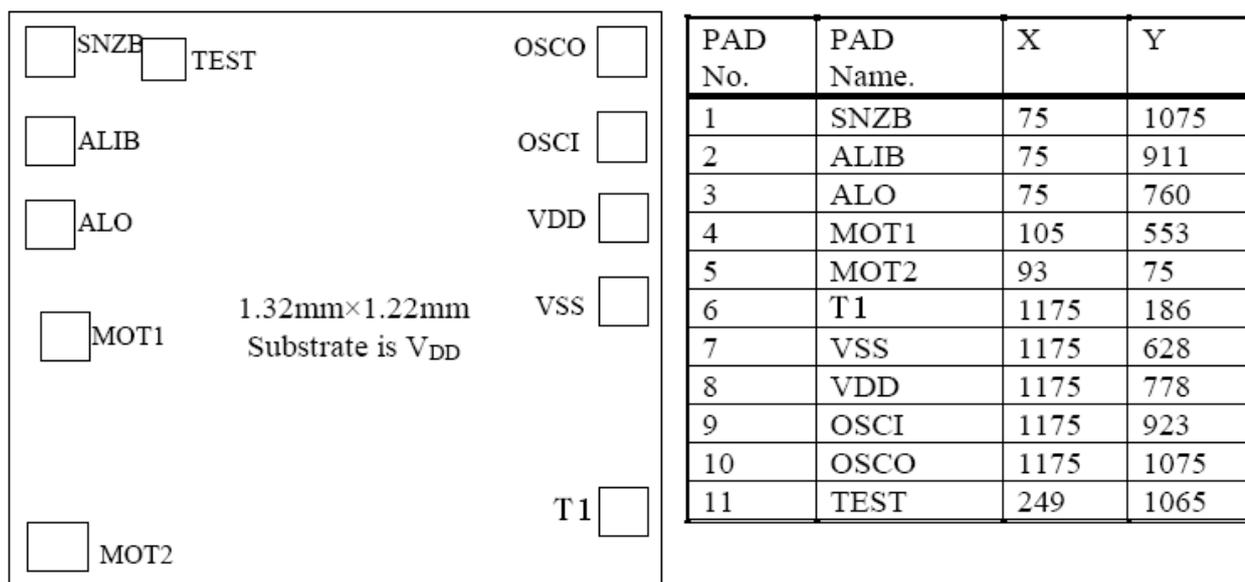

Analog alarm clock with snoozeTYPE LIST

TYPE	ALO	MOT frequency	MOT pulse width
SDL1135	4 step	16Hz	31.25ms

4-step Alarm Waveform

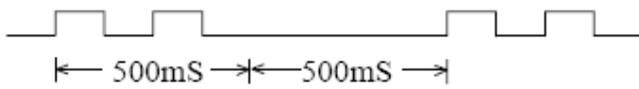
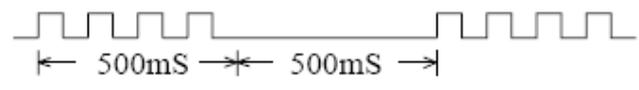
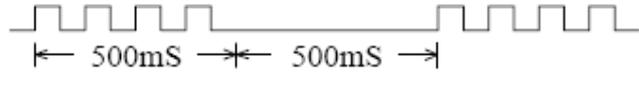
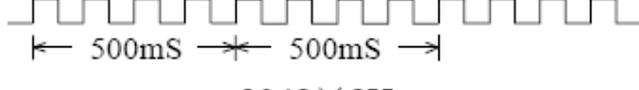
Time (sec) After Turning Alarm on	Alarm Waveform	Duty (%) of Fundamental Wave
1~8	 <p style="text-align: center;"> $2048 \times 4 \times 1\text{Hz}$ </p>	 <p style="text-align: center;">12.5%</p>
9~16	 <p style="text-align: center;"> $2048 \times 8 \times 1\text{Hz}$ </p>	 <p style="text-align: center;">25%</p>
17~24	 <p style="text-align: center;"> $2048 \times 8 \times 1\text{Hz}$ </p>	 <p style="text-align: center;">50%</p>
25~	 <p style="text-align: center;"> $2048 \times 8\text{Hz}$ </p>	 <p style="text-align: center;">50%</p>

Analog alarm clock with snooze

Snooze Waveform

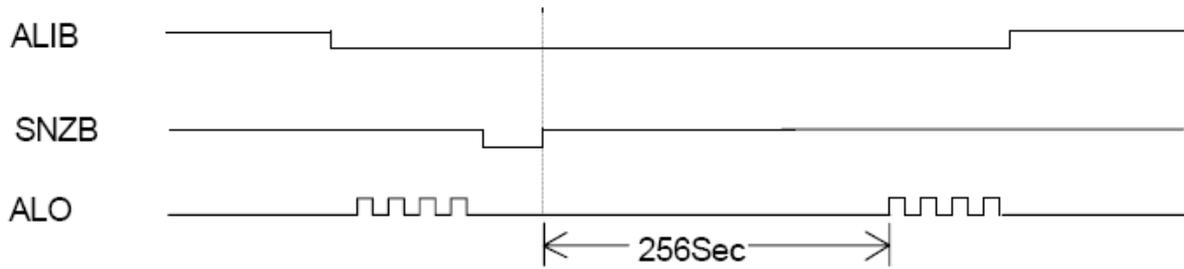

Motor Output Driving

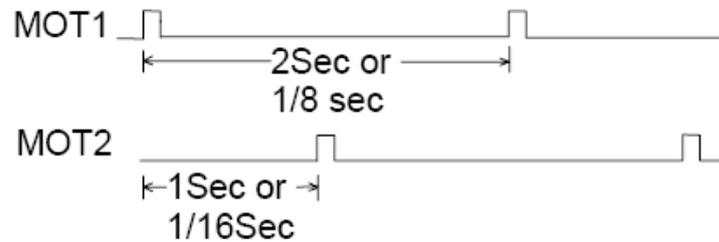

Application Diagram

Speaker application

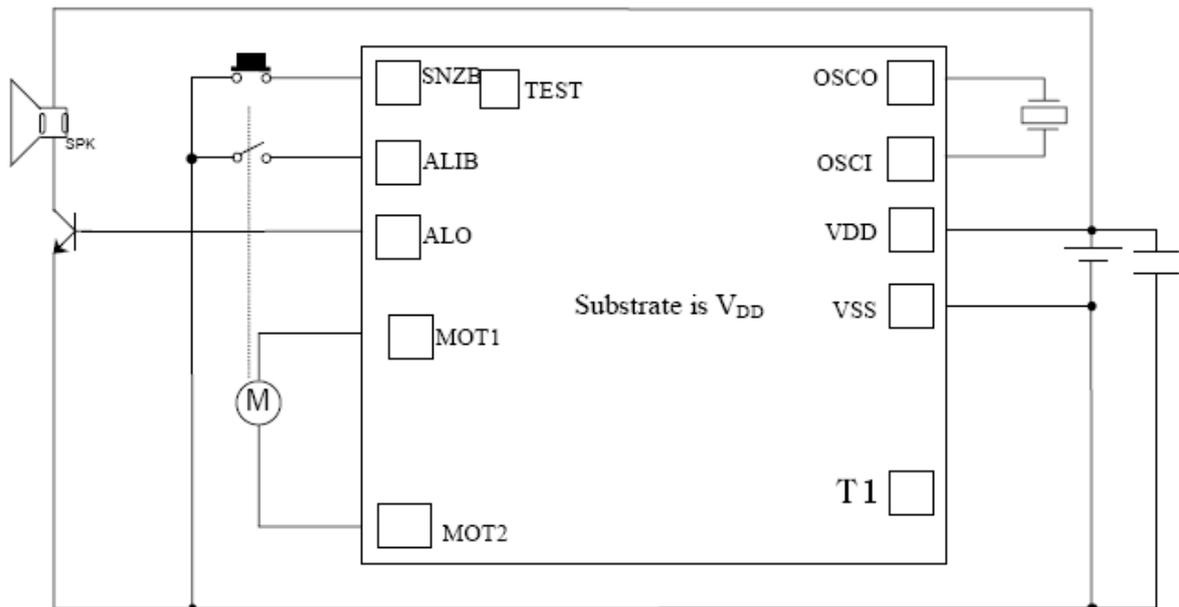

Analog alarm clock with snooze**DC Characteristics**(V_{DD}=1.5V, V_{SS}=0V, F_{osc}=32768Hz Ta=25°C unless specified otherwise)

Item	Symb.	Condition	Min.	Typ.	Max.	Unit
Supply Voltage	V _{DD}		1.1		1.8	V
Operating Current	I _{DD}	No Load		1.2	2.0	μA
Output Current		V _{DD} =1.2V				
Motor	I _M	RL=200Ω	4.5			mA
Alarm high	I _{OHA}	V _{OHA} =0.7V	0.1	0.25	0.35	mA
Alarm low	I _{OLA}	V _{OLA} =0.5V	0.1	0.25	0.35	mA
OSC. Start time		V _{DD} =1.2V			2	sec
OSC. Stability	Δf/f	ΔV _{DD} =0.1V		0.5	1	ppm
Internal Cap.	C _d			25		pF
Internal Cap.	C _g	Mask Option	5		25	pF