

RS232 Data Communication
Ranges: 0-2 to 0-50 inches
Compact Size • OEM Applications

PT1232

Specification Summary:

GENERAL

Full Stroke Ranges..... 0-2 to 0-50 inches
 Electrical Interface..... RS232
 Format..... Hex
 Accuracy..... ± 0.25 to 0.10% full stroke
 Repeatability..... ± 0.02% full stroke
 Resolution..... ± 0.003% full stroke
 Measuring Cable..... 0.019-in. dia. nylon-coated stainless steel
 Enclosure Material..... glass-filled polycarbonate and anodized aluminum
 Sensor..... plastic-hybrid precision potentiometer
 Potentiometer Cycle Life..... *see ordering information*
 Maximum Retraction Acceleration..... *see ordering information*
 Weight..... 1 lb., max.

ELECTRICAL

Input Voltage..... 9...22 VDC
 Input Current..... 40 mA
 Baud Rate..... 9600 (selectable to 38.4K)
 Update Rate..... 32 msec

ENVIRONMENTAL

Environmental Suitability..... NEMA 4, IP 65
 Operating Temperature..... 0° to 185°F (-17° to 85°C)
 Vibration..... up to 10 G's to 2000 Hz maximum



The PT1232, part of our compact line of cable extension transducers, delivers position feedback via RS232 serial communication to your data acquisition or controller system. The PT1232 sends a raw 16-bit position count from 0000 to FFFF (hex). Additionally this device can be set to continuously send data or send data only when polled.

As the internal position sensing element is a precision potentiometer, this transducer maintains current accurate position even during power loss and does not need to be reset to a "home" position.

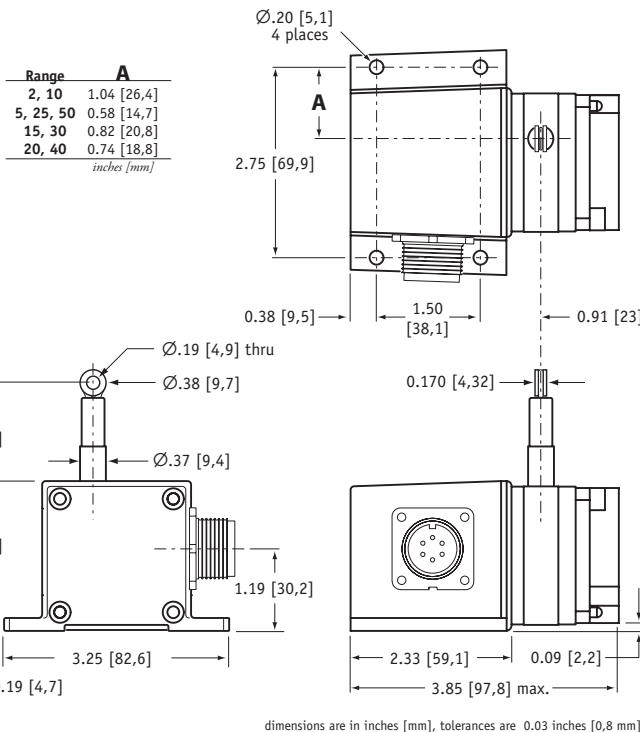

Output Signal

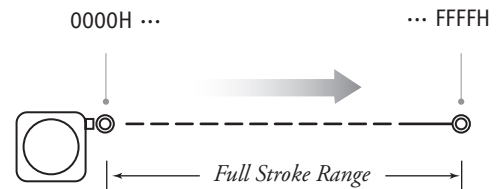

I/O Format:

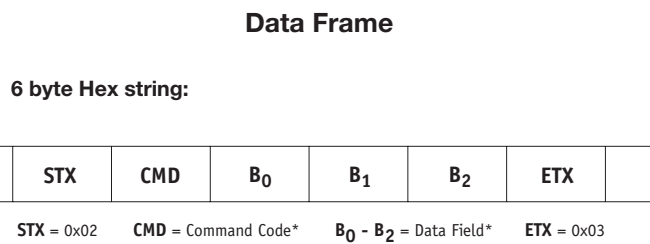
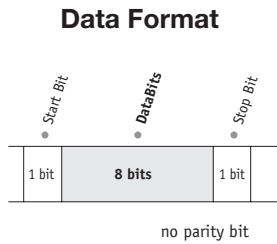

*-see below

Important! All communications to/from the transducer are in **HEX!**

User Commands:

Description	User Command				Sensor Response			
	<CMD>	<B ₀ >	<B ₁ >	<B ₂ >	<CMD>	<B ₀ >	<B ₁ >	<B ₂ >
Get Sensor Info	0x05	0x00	0x00	0x00	0x05	version ⁽⁴⁾	date ⁽⁵⁾	date ⁽⁵⁾
Get Serial Number	0x15	0x00	0x00	0x00	0x15	serial number ⁽³⁾		
Start Continuous Data	0x25	0x00	0x00	0x00	0x25	0x00	0x00	0x00
Stop Continuous Data	0x35	0x00	0x00	0x00	0x35	0x00	0x00	0x00
Get Position Data	0x45	0x00	0x00	0x00	0x45	CMC ⁽¹⁾	CMC ⁽¹⁾	status ⁽²⁾

(1) CMC - Current Measurement Count (Position)

The Current Measurement Count (CMC) is the output data that indicates the present position of the measuring cable.

The CMC is a 16-bit value that occupies the first two bytes (B₀ and B₁) of the data field. B₀ is the MSB (most significant byte) and B₁ is the LSB (least significant byte).

The CMC starts at 0000H with the measuring cable fully retracted and continues upward to the end of the stroke range stopping at FFFFH. This holds true for all ranges.

(2) Status

The status byte is used as a flag to indicate the validity of the position signal that the internal electronics receives from the potentiometer.

Flags are as follows:
0x00 = GREEN, 0x55 = YELLOW, 0xAA = RED

A "green" flag shows everything OK. A "yellow" or "red" flag indicates that the sensor has either been extended beyond its range or that there is a problem with the potentiometer.

(3) Serial Number

Each sensor has its own unique serial number. This information can be retrieved by sending the sensor the "Get Serial Number" command.

The serial number is a 3 byte value from which ranges from 0 to 9999999 (decimal).

(4) Version

This is a single byte value (0-255 decimal) which indicates the currently installed firmware version of the sensor.

(5) Date

This is a 2 byte value showing the date of currently installed firmware. This value ranges from 01011 - 12319 (decimal). Format is MMDDY. While the month and day are expressed as two digit numbers the year is expressed in a single digit only.

Example: 08054 = August 5, 2004

Baud Rate

The baud rate can be set using switches 7 & 8 on the 8-pole DIP switch found on the rs232 controller board located inside the transducer.

DIP-7	DIP-8	baud rate
0	0	9600
1	0	19200
0	1	38400
1	1	9600



RS232 Controller Board and DIP Switch Location

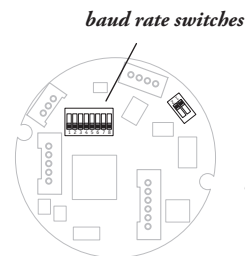

to gain access to the controller board, remove four Allen-Head Screws and remove rear cover.

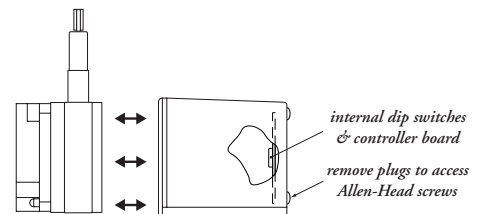

Ordering Information:

Model Number:

PT1232 - - - -
order code: **R** **A** **B** **C**

Sample Model Number:

PT1232 - 50 - UP - M6 - SG

- R** range: 50 inches
- A** measuring cable exit: up (top exit)
- B** electrical connection: 6-pin plastic connector
- C** cable guide: spring loaded

Full Stroke Range:

R <i>order code:</i>	2	5	10	15	20	25	30	40	50
full stroke range, min:	2 in.	5 in.	10 in.	15 in.	20 in.	25 in.	30 in.	40 in.	50 in.
accuracy (% of f.s.):	0.25%		0.15%			0.10%			
potentiometer cycle life:	2,500,000 cycles		500,000 cycles			250,000 cycles			
cable tension (20%):	12 oz.	5 oz.	12 oz.	9 oz.	6 oz.	5 oz.	9 oz.	6 oz.	5 oz.
maximum cable acceleration:	11 G's	3 G's	11 G's	5 G's	4 G's	3 G's	5 G's	4 G's	3 G's

Cable Exit:

A *order code:* **UP** **DN** **FR** **BK**
 direction: up down front back

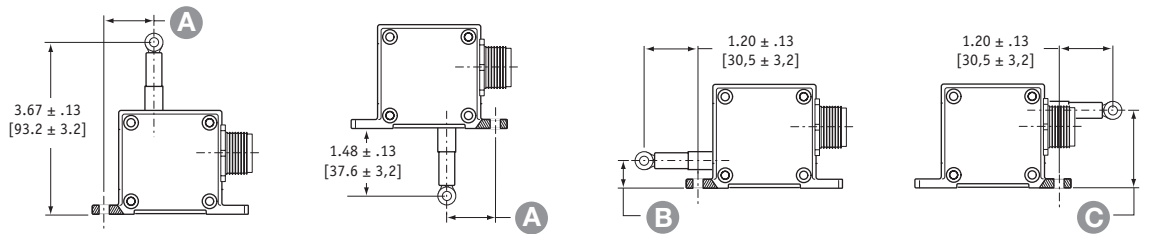

<i>measurement range</i>	2	5	10	15	20	25	30	40	50
A	1.04 in. 26,4 mm	0.58 in. 14,7 mm	1.04 in. 26,4 mm	0.82 in. 20,8 mm	0.74 in. 18,8 mm	0.58 in. 14,7 mm	0.82 in. 20,8 mm	0.74 in. 18,8 mm	0.58 in. 14,7 mm
B	0.75 in. 19,1 mm	0.29 in. 6,1 mm	0.75 in. 19,1 mm	0.53 in. 13,5 mm	0.45 in. 11,5 mm	0.29 in. 6,1 mm	0.53 in. 13,5 mm	0.45 in. 11,5 mm	0.29 in. 6,1 mm
C	1.43 in. 36,3 mm	1.89 in. 48,0 mm	1.43 in. 36,3 mm	1.65 in. 41,9 mm	1.73 in. 43,9 mm	1.89 in. 48,0 mm	1.65 in. 41,9 mm	1.73 in. 43,9 mm	1.89 in. 48,0 mm

Electrical Connection:

B *order code:* **M6** **C25**
 6-pin plastic connector with mating plug 25-ft. instrumentation cable 24 AWG, shielded

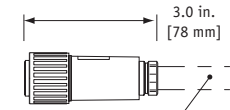

.30 - .39 in. [8 - 10 mm] cable dia.
 16 AWG max conductor size
 connector: MS3102E-14S-6P
 mating plug: MS3106E-14S-6S

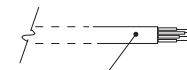

25 ft. x 0.2-in. dia.
 [7,5 M x 5 mm dia.]
 24 AWG, shielded

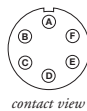

- pin**
 - A**
 - B**
 - C**
 - D**
 - E**
 - F**
- signal**
 - 9...22 VDC common
 - Transmitted Data
 - Received Data
 - common

- color code**
 - Red
 - Black
 - White
 - Green
 - Blue
 - Brown
- signal**
 - 9...22 VDC common
 - Transmitted Data
 - Received Data
 - common

Cable Guide:

Ⓢ order code:

blank

standard cable guide

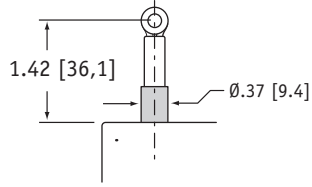

SG

spring-loaded guide

cushions impact from accidental free release

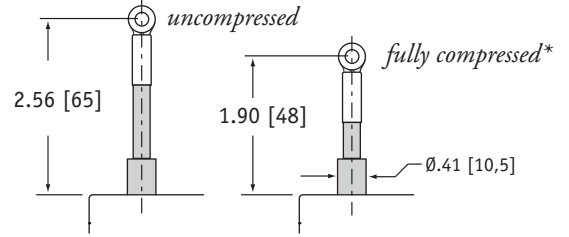

**note: start of full stroke range begins at full compression point (except 2-inch and 5-inch ranges).*

version: 3.0 last updated: April 28, 2010

celesco

tel: 800.423.5483 • +1.818.701.2750 • fax: +1.818.701.2799

celesco.com • info@celesco.com